



## SX-F

High power Direct Torque Control Inverters

Model: SX-F

400 V Class Three-Phase Input 0.75 kW to 800 kW

690 V Class Three-Phase Input 90 kW to 1000 kW

## INSTRUCTION MANUAL

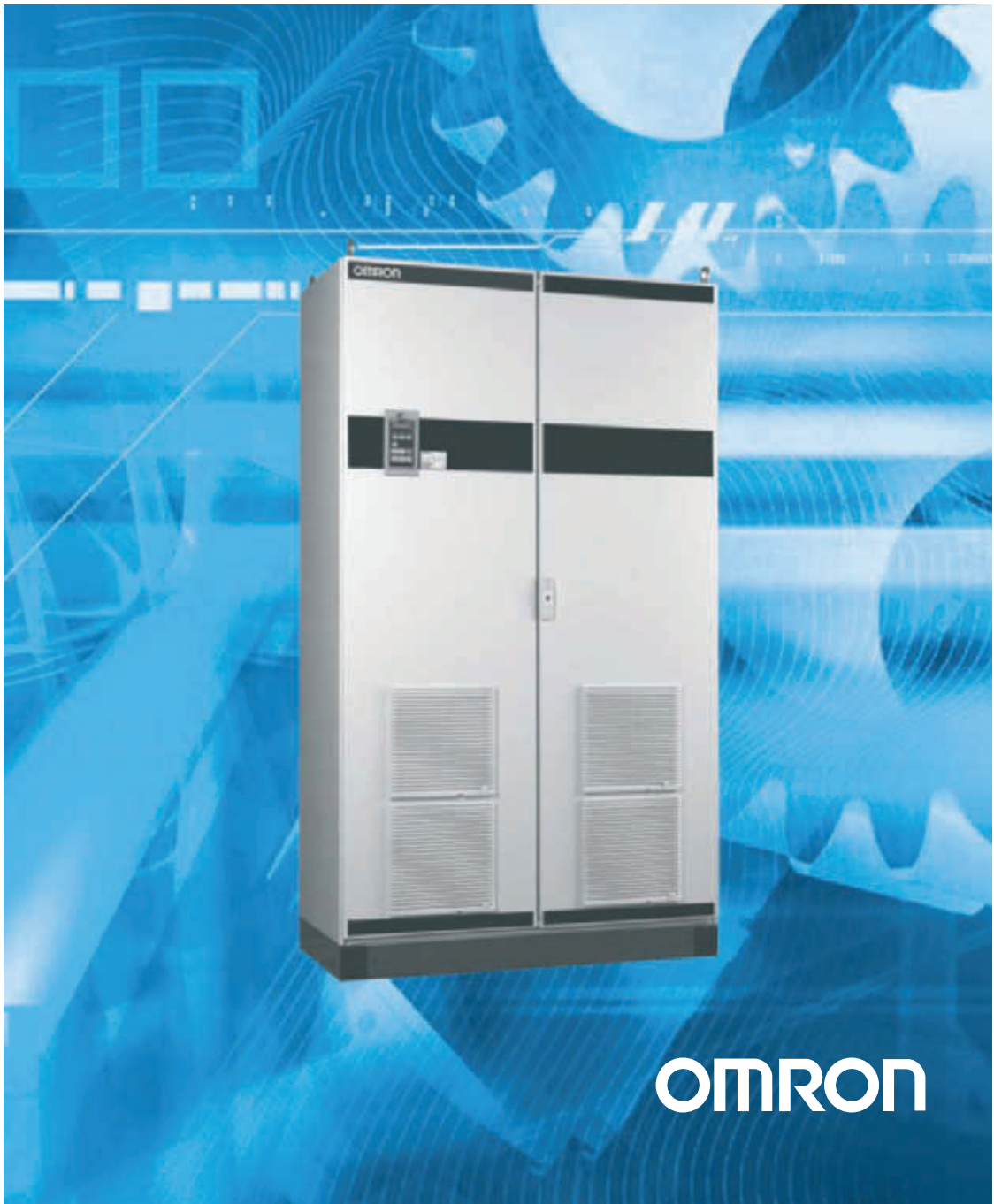

**OMRON**



# **OMRON SX-F**

## **INSTRUCTION MANUAL - ENGLISH**

Software version 4.3X and higher

Document number: **I126E-EN-03**

Document name : Omron SX inverter manual

Date of release: 03-2012

© OMRON, 2012

All rights reserved. No part of this publication may be reproduced, stored in a retrieval system, or transmitted, in any form, or by any means, mechanical, electronic, photocopying, recording, or otherwise, without the prior written permission of OMRON.

No patent liability is assumed with respect to the use of the information contained herein. Moreover, because OMRON is constantly striving to improve its high-quality products, the information contained in this manual is subject to change without notice. Every precaution has been taken in the preparation of this manual.

Nevertheless, OMRON assumes no responsibility for errors or omissions. Neither is any liability assumed for damages resulting from the use of the information contained in this publication.

# Warranty and Limitations of Liability

WARRANTY
<p>OMRON's exclusive warranty is that the products are free from defects in materials and workmanship for a period of one year (or other period if specified) from date of sale by OMRON.</p> <p>OMRON MAKES NO WARRANTY OR REPRESENTATION, EXPRESS OR IMPLIED, REGARDING NONINFRINGEMENT, MERCHANTABILITY, OR FITNESS FOR PARTICULAR PURPOSE OF THE PRODUCTS. ANY BUYER OR USER ACKNOWLEDGES THAT THE BUYER OR USER ALONE HAS DETERMINED THAT THE PRODUCTS WILL SUITABLY MEET THE REQUIREMENTS OF THEIR INTENDED USE. OMRON DISCLAIMS ALL OTHER WARRANTIES, EXPRESS OR IMPLIED.</p>

LIMITATIONS OF LIABILITY
<p>OMRON SHALL NOT BE RESPONSIBLE FOR SPECIAL, INDIRECT, OR CONSEQUENTIAL DAMAGES, LOSS OF PROFITS OR COMMERCIAL LOSS IN ANY WAY CONNECTED WITH THE PRODUCTS, WHETHER SUCH CLAIM IS BASED ON CONTRACT, WARRANTY, NEGLIGENCE, OR STRICT LIABILITY.</p> <p>In no event shall the responsibility of OMRON for any act exceed the individual price of the product on which liability is asserted.</p> <p>IN NO EVENT SHALL OMRON BE RESPONSIBLE FOR WARRANTY, REPAIR, OR OTHER CLAIMS REGARDING THE PRODUCTS UNLESS OMRON'S ANALYSIS CONFIRMS THAT THE PRODUCTS WERE PROPERLY HANDLED, STORED, INSTALLED, AND MAINTAINED AND NOT SUBJECT TO CONTAMINATION, ABUSE, MISUSE, OR INAPPROPRIATE MODIFICATION OR REPAIR.</p>

# Application Considerations

SUITABILITY FOR USE
<p>OMRON shall not be responsible for conformity with any standards, codes, or regulations that apply to the combination of products in the customer's application or use of the products.</p> <p>At the customer's request, OMRON will provide applicable third party certification documents identifying ratings and limitations of use that apply to the products. This information by itself is not sufficient for a complete determination of the suitability of the products in combination with the end product, machine, system, or other application or use.</p> <p>The following are some examples of applications for which particular attention must be given. This is not intended to be an exhaustive list of all possible uses of the products, nor is it intended to imply that the uses listed may be suitable for the products:</p> <ul style="list-style-type: none"><li>o Outdoor use, uses involving potential chemical contamination or electrical interference, or conditions or uses not described in this manual.</li><li>o Nuclear energy control systems, combustion systems, railroad systems, aviation systems, medical equipment, amusement machines, vehicles, safety equipment, and installations subject to separate industry or government regulations.</li><li>o Systems, machines, and equipment that could present a risk to life or property.</li></ul> <p>Please know and observe all prohibitions of use applicable to the products.</p> <p>NEVER USE THE PRODUCTS FOR AN APPLICATION INVOLVING SERIOUS RISK TO LIFE OR PROPERTY WITHOUT ENSURING THAT THE SYSTEM AS A WHOLE HAS BEEN DESIGNED TO ADDRESS THE RISKS, AND THAT THE OMRON PRODUCTS ARE PROPERLY RATED AND INSTALLED FOR THE INTENDED USE WITHIN THE OVERALL EQUIPMENT OR SYSTEM.</p>

## ***Disclaimers***

### **PROGRAMMABLE PRODUCTS**

OMRON shall not be responsible for the user's programming of a programmable product, or any consequence thereof.

### **CHANGE IN SPECIFICATIONS**

Product specifications and accessories may be changed at any time based on improvements and other reasons. It is our practice to change model numbers when published ratings or features are changed, or when significant construction changes are made. However, some specifications of the products may be changed without any notice. When in doubt, special model numbers may be assigned to fix or establish key specifications for your application on your request. Please consult with your OMRON representative at any time to confirm actual specifications of purchased products.

### **DIMENSIONS AND WEIGHTS**

Dimensions and weights are nominal and are not to be used for manufacturing purposes, even when tolerances are shown.





### **PERFORMANCE DATA**







Performance data given in this manual is provided as a guide for the user in determining suitability and does not constitute a warranty. It may represent the result of OMRON's test conditions, and the users must correlate it to actual application requirements. Actual performance is subject to the OMRON Warranty and Limitations of Liability.











### **ERRORS AND OMISSIONS**











The information in this manual has been carefully checked and is believed to be accurate; however, no responsibility is assumed for clerical, typographical, or proof-reading errors, or omissions.

# Safety Instructions

<b>Precautions severity</b>	
	Danger. High immediate risk of serious injury or death. In addition there may be severe damage to the inverter, installation or other property.
	Warning. Potential risk for malfunction or severe damage to the inverter or installation. Possibility of serious injury or death to the user.
	Caution. Follow this advice for good practice. Not following can lead to malfunctioning or possibility of injury to the user.
	Earth and grounding. Potential risk of electric shock or damage to inverter or installation.
	Risk if manipulated by unqualified personnel

<b>WARNINGS AND CAUTIONS</b>	
	<p><b>Instruction manual</b></p> <p>Read throughfully this instruction manual before using the Variable Speed Drive, VSD</p>
	<p><b>Mains voltage selection</b></p> <p>The variable speed drive may be ordered for use with the mains voltage range listed below.            SX-F-4: 230-480 V            SX-F-6: 500-690 V</p>
	<p><b>IT Mains supply</b></p> <p>The variable speed drives can be modified for an IT mains supply, (non-earthed neutral), check manual and contract your supplier in case of doubt.</p>
	<p><b>EMC Regulations</b></p> <p>In order to comply with the EMC Directive, it is absolutely necessary to follow the installation instructions.</p>
	<p><b>Transport</b></p> <p>To avoid damage, keep the variable speed drive in its original packaging during transport. This packaging is specially designed to absorb shocks during transport.</p>
	<p><b>Handling the inverter</b></p> <p>Installation, commissioning, dismounting, taking measurements, etc, of or on the variable speed drive may only be carried out by personnel technically qualified for the task. The installation must be carried out in accordance with local standards.</p>

	<p><b>Condensation</b></p> <p>If the variable speed drive is moved from a cold (storage) room to a room where it will be installed, condensation can occur. This can result in sensitive components becoming damp. Do not connect the mains voltage until all visible dampness has evaporated.</p>
	<p><b>Grounding the inverter</b></p> <p>Be sure to ground the unit. Not doing so may result in a serious injury due to an electric shock or fire.</p>
	<p><b>Power factor capacitors for improving <math>\cos\phi</math></b></p> <p>Remove all capacitors from the motor and the motor outlet.</p>
	<p><b>Incorrect connection</b></p> <p>The variable speed drive is not protected against incorrect connection of the mains voltage, and in particular against connection of the mains voltage to the motor outlets U, V and W. The variable speed drive can be damaged in this way.</p>
	<p><b>Stop motion mechanical device to ensure safety</b></p> <p>The inverter controls the motor electrically, but has no means to stop it mechanically under some types of failures... In applications where mechanical stop is required to a degree of safety, a safety assurance study should be carried out to determine the need of additional mechanical braking devices.</p>
	<p><b>Braking resistor and regenerative braking units</b></p> <p>In case the application needs it, be sure to use a specified type of braking resistor/regenerative braking unit. In case of a braking resistor, install a thermal relay that monitors the temperature of the resistor. Not doing so might result in a burn due to the heat generated in the braking resistor/regenerative braking unit. Configure a sequence that enables the Inverter power to turn off when unusual overheating is detected in the braking resistor/regenerative braking unit.</p>
	<p><b>Electric protection of installation</b></p> <p>Take safety precautions such as setting up a molded-case circuit breaker (MCCB) or fuses that matches the Inverter capacity on the power supply side. Not doing so might result in damage to property due to the short circuit of the load.</p>
	<p><b>Wiring works and servicing the inverter</b></p> <p>Wiring work must be carried out only by qualified personnel. Not doing so may result in a serious injury due to an electric shock. Do not dismantle, repair or modify this product if you're not authorised and qualified for it. Doing so may result in an injury.</p>
	<p><b>DC-link residual voltage</b></p> <p>After switching off the mains supply, dangerous voltage can still be present in the VSD. When opening the VSD for installing and/or commissioning activities wait at least 10 minutes. In case of malfunction a qualified technician should check the DC-link or wait for one hour before dismantling the VSD for repair.</p>
	<p><b>Opening the variable speed drive cover</b></p> <p>Only qualified technician can open the inverter. Always take adequate precautions before opening the inverter. Although the connections for the control signals and the switches are isolated from the main voltage, do not touch the control board when the variable speed drive is switched on.</p>
	<p><b>Do not manipulate inverter under power</b></p> <p>Do not change wiring, put on or take off optional devices or replace cooling fans while the input power is being supplied. Doing so may result in a serious injury due to an electric shock. Inspection of the Inverter must be conducted after the power supply has been turned off. Not doing so may result in a serious injury due to an electric shock. The main power supply is not necessarily shut off even if the emergency shutoff function is activated.</p>

	<p><b>Precautions to be taken with a connected motor</b></p> <p>If work must be carried out on a connected motor or on the driven machine, the mains voltage must always be disconnected from the variable speed drive first. Wait at least 5 minutes before starting work.</p>
	<p><b>Short-circuits</b></p> <p>The Inverter has high voltage parts inside which, if short-circuited, might cause damage to itself or other property. Place covers on the openings or take other precautions to make sure that no metal objects such as cutting bits or lead wire scraps go inside when installing and wiring.</p>
	<p><b>Earth leakage current</b></p> <p>This variable speed drive has an earth leakage current which does exceed 3.5 mA AC. Therefore the minimum size of the protective earth conductor must comply with the local safety regulations for high leakage current equipment which means that according the standard IEC61800-5-1 the protective earth connection must be assured by one of following conditions:</p> <ol style="list-style-type: none"> <li>1. PE conductor cross-sectional area shall for cable size <math>\leq 16\text{mm}^2</math> be equal to the used phase conductors, for cable size above <math>16\text{mm}^2</math> but smaller or equal to <math>35\text{mm}^2</math> the PE conductor cross-sectional area shall be at least <math>16\text{mm}^2</math>. For cables <math>&gt; 35\text{mm}^2</math> the PE conductor cross-sectional area should be at least 50% of the used phase conductor.</li> <li>2. When the PE conductor in the used cable type is not in accordance with the above mentioned cross-sectional area requirements, a separate PE conductor should be used to establish this.</li> </ol>
	<p><b>Residual current device (RCD) compatibility</b></p> <p>This product cause a DC current in the protective conductor. Where a residual current device (RCD) is used for protection in case of direct or indirect contact, only a Type B RCD is allowed on the supply side of this product. Use RCD of 300 mA minimum.</p>
	<p><b>Voltage tests (Megger)</b></p> <p>Do not carry out voltage tests (Megger) on the motor, before all the motor cables have been disconnected from the variable speed drive.</p>
	<p><b>Precautions during Autoreset</b></p> <p>When the automatic reset is active, the motor may restart automatically provided that the cause of the trip has been removed. If necessary take the appropriate precautions.</p>
	<p><b>Heat warning</b></p> <p>Be aware of specific parts on the VSD having high temperature. Do not touch the Inverter fins, braking resistors and the motor, which may become too hot during the power supply and for some time after the power shut-off. Doing so may result in a burn.</p>
	<p><b>Do not Operate the inverter with wet hands</b></p> <p>Do not operate the Digital Operator or switches with wet hands. Doing so may result in a serious injury due to an electric shock.</p>
	<p><b>Warning</b></p> <p>The Brake Resistor must be connected between terminals DC+ and R.</p>
	<p><b>Warning</b></p> <p>In order to work safely, the mains earth must be connected to PE and the motor earth to <math>\perp</math>.</p>



# Table of contents

<b>Safety Instructions</b> .....	<b>iv</b>
Precautions severity .....	iv
WARNINGS AND CAUTIONS .....	iv
<b>SECTION 1</b>	
<b>Introduction</b> .....	<b>7</b>
1-1 Delivery and unpacking .....	7
1-2 Using the instruction manual .....	7
1-3 Ordering codes .....	8
1-4 Standards .....	9
1-4-1 Product standard for EMC .....	9
1-5 Dismantling and scrapping .....	10
1-6 Glossary .....	11
1-6-1 Abbreviations and symbols .....	11
1-6-2 Definitions .....	11
<b>SECTION 2</b>	
<b>Mounting</b> .....	<b>13</b>
2-1 Lifting instructions .....	13
2-2 Stand-alone units .....	16
2-2-1 Cooling .....	16
2-2-2 Mounting schemes .....	17
2-3 Cabinet mounting .....	21
2-3-1 Cooling .....	21
2-3-2 Recommended free space in front of cabinet .....	21
2-3-3 Mounting schemes .....	22
<b>SECTION 3</b>	
<b>Installation</b> .....	<b>25</b>
3-1 Before installation .....	25
3-2 Cable connections .....	25
3-2-1 Mains cables .....	25
3-2-2 Motor cables .....	27
3-3 Connect motor and mains cables .....	31
3-3-1 Connection of mains and motor cables on IP20 modules .....	33
3-4 Cable specifications .....	34
3-5 Stripping lengths .....	34
3-5-1 Dimension of cables and fuses .....	34
3-5-2 Tightening torque for mains and motor cables .....	34
3-6 Thermal protection on the motor .....	35
3-7 Motors in parallel .....	35

**SECTION 4**

<b>Getting Started</b> .....	<b>37</b>
4-1 Connect the mains and motor cables .....	37
4-1-1 Mains cables .....	37
4-1-2 Motor cables .....	37
4-2 Using the function keys .....	38
4-3 Remote control .....	38
4-3-1 Connect control cables .....	38
4-3-2 Switch on the mains .....	39
4-3-3 Set the Motor Data .....	39
4-3-4 Run the VSD .....	40
4-4 Local control .....	40
4-4-1 Switch on the mains .....	40
4-4-2 Select manual control .....	40
4-4-3 Set the Motor Data .....	40
4-4-4 Enter a Reference Value .....	40
4-4-5 Run the VSD .....	40

**SECTION 5**

<b>Control Connections</b> .....	<b>41</b>
5-1 Control board .....	41
5-2 Terminal connections .....	42
5-3 Inputs configuration with the switches .....	43
5-4 Connection example .....	44
5-5 Connecting the Control Signals .....	45
5-5-1 Cables .....	45
5-5-2 Types of control signals .....	47
5-5-3 Screening .....	48
5-5-4 Single-ended or double-ended connection? .....	48
5-5-5 Current signals ((0)4-20 mA) .....	48
5-5-6 Twisted cables .....	49
5-6 Connecting options .....	49

**SECTION 6**

<b>Applications</b> .....	<b>51</b>
6-1 Applications .....	51
6-1-1 Cranes .....	51
6-1-2 Crushers .....	51
6-1-3 Mills .....	51
6-1-4 Mixers .....	52

**SECTION 7**

<b>Main Features</b> .....	<b>53</b>
7-1 Parameter sets .....	53
7-1-1 One motor and one parameter set .....	55
7-1-2 One motor and two parameter sets .....	55
7-1-3 Two motors and two parameter sets .....	55
7-1-4 Autoreset at trip .....	55
7-1-5 Reference priority .....	56
7-1-6 Preset references .....	56
7-2 Remote control functions .....	57
7-3 Performing an Identification Run .....	60
7-4 Using the Control Panel Memory .....	61
7-5 Load Monitor and Process Protection [400] .....	62
7-5-1 Load Monitor [410] .....	62

**SECTION 8**

<b>EMC</b> .....		<b>65</b>
8-1 EMC standards .....		65

**SECTION 9**

<b>Operation via the Control Panel</b> .....		<b>67</b>
9-1 General .....		67
9-2 The control panel .....		67
9-2-1 The display .....		67
9-2-2 Indications on the display .....		69
9-2-3 LED indicators .....		69
9-2-4 Control keys .....		69
9-2-5 The Toggle and Loc/Rem Key .....		70
9-2-6 Function keys .....		72
9-3 The menu structure .....		73
9-3-1 The main menu .....		74
9-4 Programming during operation .....		74
9-5 Editing values in a menu .....		75
9-6 Copy current parameter to all sets .....		75
9-7 Programming example .....		75

**SECTION 10**

<b>Serial communication</b> .....		<b>77</b>
10-1 Modbus RTU .....		77
10-2 Parameter sets .....		78
10-3 Motor data .....		78
10-4 Start and stop commands .....		79
10-5 Reference signal .....		79
10-5-1 Process value .....		79
10-6 Description of the EInt formats .....		80

**SECTION 11**

<b>Functional Description</b> .....	<b>83</b>
11-1 Preferred View [100] .....	83
11-1-1 1st Line [110] .....	84
11-1-2 2nd Line [120] .....	84
11-2 Main Setup [200] .....	84
11-2-1 Operation [210] .....	85
11-2-2 Remote Signal Level/Edge [21A] .....	90
11-2-3 Mains supply voltage [21B] .....	91
11-2-4 Motor Data [220] .....	91
11-2-5 Motor Protection [230] .....	98
11-2-6 Parameter Set Handling [240] .....	102
11-2-7 Trip Autoreset/Trip Conditions [250] .....	106
11-2-8 Serial Communication [260] .....	118
11-3 Process and Application Parameters [300] .....	123
11-3-1 Set/View Reference Value [310] .....	123
11-3-2 Process Settings [320] .....	124
11-3-3 Start/Stop settings [330] .....	131
11-3-4 Mechanical brake control .....	138
11-3-5 Speed [340] .....	142
11-3-6 Torques [350] .....	147
11-3-7 Preset References [360] .....	150
11-3-8 PI Speed Control [370] .....	152
11-3-9 PID Process Control [380] .....	154
11-3-10 Crane Option [3A0] .....	171
11-4 Load Monitor and Process Protection [400] .....	177
11-4-1 Load Monitor [410] .....	177
11-4-2 Process Protection [420] .....	184
11-5 I/Os and Virtual Connections [500] .....	187
11-5-1 Analogue Inputs [510] .....	187
11-5-2 Digital Inputs [520] .....	198
11-5-3 Analogue Outputs [530] .....	201
11-5-4 Digital Outputs [540] .....	207
11-5-5 Relays [550] .....	210
11-5-6 Virtual Connections [560] .....	213
11-6 Logical Functions and Timers [600] .....	215
11-6-1 Comparators [610] .....	215
11-6-2 Logic Output Y [620] .....	230
11-6-3 Logic Output Z [630] .....	233
11-6-4 Timer1 [640] .....	235
11-6-5 Timer2 [650] .....	238
11-7 View Operation/Status [700] .....	241
11-7-1 Operation [710] .....	241
11-7-2 Status [720] .....	245
11-7-3 Stored values [730] .....	250
11-8 View Trip Log [800] .....	253
11-8-1 Trip Message log [810] .....	253
11-8-2 Trip Messages [820] - [890] .....	254
11-8-3 Reset Trip Log [8A0] .....	255
11-9 System Data [900] .....	256
11-9-1 VSD Data [920] .....	256

**SECTION 12**

**Troubleshooting, Diagnoses and Maintenance** ..... **259**

12-1 Trips, warnings and limits ..... 259

12-2 Trip conditions, causes and remedial action ..... 261

    12-2-1 Technically qualified personnel ..... 261

    12-2-2 Opening the variable speed drive ..... 261

    12-2-3 Precautions to take with a connected motor ..... 261

    12-2-4 Autoreset Trip ..... 262

12-3 Maintenance ..... 264

**SECTION 13**

**Options** ..... **267**

13-1 Options for the control panel ..... 267

13-2 CX-Drive software ..... 267

13-3 Brake chopper ..... 268

13-4 I/O Board ..... 270

13-5 Encoder ..... 270

13-6 PTC/PT100 ..... 270

13-7 Crane option board ..... 270

13-8 Serial communication and fieldbus ..... 270

13-9 Standby supply board option ..... 271

13-10 Safe Stop option ..... 273

13-11 Output coils ..... 275

13-12 Liquid cooling ..... 275

**SECTION 14**

**Technical Data** ..... **277**

14-1 Electrical specifications related to model ..... 277

14-2 General electrical specifications ..... 278

14-3 Operation at higher temperatures ..... 280

14-4 Dimensions and Weights ..... 281

14-5 Environmental conditions ..... 281

14-6 Fuses, cable cross-sections and glands ..... 282

    14-6-1 According IEC ratings ..... 282

    14-6-2 Fuses and cable dimensions according NEMA ratings ..... 284

14-7 Control signals ..... 286

**SECTION 15**

**Menu List** ..... **287**

**Index** ..... **303**



# SECTION 1

## Introduction

Omron SX-F is intended for controlling the speed and torque of standard three phase asynchronous electrical motors. The VSD is equipped with direct torque control which uses built-in DSP, giving the VSD the capability of high dynamic performance even at very low speeds without using feedback signals from the motor. Therefore the inverter is designed for use in high dynamic applications where low speed high torque and high-speed accuracy are demanded. In “simpler” application such as fans or pumps, the SX-F direct torque control offers other great advantages such as insensitivity to mains disturbances or load shocks.

### Users

This instruction manual is intended for:

- Installation engineers
- Maintenance engineers
- Operators
- Service engineers

### Motors

The variable speed drive is suitable for use with standard 3-phase asynchronous motors. Under certain conditions it is possible to use other types of motors. Contact your supplier for details.

## 1-1 Delivery and unpacking

Check for any visible signs of damage. Inform your supplier immediately of any damage found. Do not install the variable speed drive if damage is found.

The variable speed drives are delivered with a template for positioning the fixing holes on a flat surface. Check that all items are present and that the type number is correct.

## 1-2 Using the instruction manual

Within this instruction manual the abbreviation “VSD” is used to indicate the complete variable speed drive as a single unit.

Check that the software version number on the first page of this manual matches the software version in the variable speed drive.

With help of the index and the contents it is easy to track individual functions and to find out how to use and set them.

The Quick Setup Card can be put in a cabinet door, so that it is always easy to access in case of an emergency.

### 1-3 Ordering codes

Fig. 1 and Fig. 2 give examples of the ordering code numbering used on SX variable speed drives. With this code number the exact type of the drive can be determined. This identification will be required for type specific information when mounting and installing. The code number is located on the product label, on the front of the unit.

1    2    3    4    5    6    7  
 SX- D    6    160- E    F    -OPTIONS

Fig. 1 Type code number

Position	n.chars	Configuration	
1	3	Inverter family name	"SX-"
2	1	Protection class	"A"=IP20 "D"=IP54
3	1	Voltage Class	"4"=400V "6"=690V
4	4	Power in kW (normal duty rating)	"0P7-"=0.75kW ... "1K0-"=1000kW
5	1	Market	"E"=Europe "E1"=Europe IP54 cabinet with front door fan
6	6	Control type	"F"=Direct Torque Control
7	0 to 13	All options with single letter (see table below)	"-" + letters A to Z

Fig. 2 Option letters

Options	Letter ("?" means no character)
Control panel	"?" = Standard control panel (Std.PPU) "A" = Blank control panel (Blank PPU)
Built-in EMC filter	"?" = Standard EMC inside (Category C3) "B" = IT-Net (filter disconnected from ground)
Built-in brake chopper	"?" = No brake chopper or DC-connection included "C" = Brake chopper & DC-connection included "D" = Only DC-connection included
Standby power supply	"?" = Not included "E" = Standby power supply included
Safe stop	"?" = Not included "F" = Safe stop included
Coated boards	"?" = No coating "G" = Coated boards
Option board position 1	"?" = No option "H" = Crane I/O "I" = Encoder "J" = PTC/PT100 "K" = Extended I/O"
Option board position 2	"?" = No option "I" = Encoder "J" = PTC/PT100 "K" = Extended I/O"



Options	Letter ("?" means no character)
Option board position 3	"?" = No option "I" = Encoder "J" = PTC/PT100 "K" = Extended I/O
Option board Fieldbus position 4	"?" = No option "L" = DeviceNet "M" = Profibus-DP "M1" = Profinet "N" = RS232/485 "O" = EtherNet Modbus TCP "O1" = EtherCAT
Liquid Cooling	"?" = No Liquid Cooling "P" = Liquid Cooling
Standard	"?" = IEC "Q" = UL
Marine	"?" = No marine option "R" = Marine option included
Cabinet input options	"?" = No cabinet input options "S" = Main switch included "T" = Main contactor included "U" = Main switch + contactor included
Cabinet output options	"?" = No cabinet output options included "V" = dU/dt filter included "W" = dU/dt filter + Overshoot clamp included "X" = Sinus filter included "X1" = All-pole sinus filter included
Additional options	"Z1" = Common mode output filter "Z2" = Cable Gland kit "Z3" = Motor PTC connection Options only available for model between 0.37 and 37KW

## 1-4 Standards

The variable speed drives described in this instruction manual comply with the standards listed in Table 2. For the declarations of conformity contact your supplier for more information.

### 1-4-1 Product standard for EMC

Product standard EN(IEC)61800-3, defines the:

**First Environment** (Extended EMC) as environment that includes domestic premises. It also includes establishments directly connected without intermediate transformers to a low voltage power supply network that supplies buildings used for domestic purposes.

Category C2: Power Drive System (PDS) of rated voltage <1.000 V, which is neither a plug in device nor a movable device and, when used in the first environment, is intended to be installed and commissioned only by a professional.

**Second environment** (Standard EMC) includes all other establishments.

Category C3: PDS of rated voltage <1.000 V, intended for use in the second environment and not intended for use in the first environment.

Category C4: PDS or rated voltage equal or above 1.000 V, or rated current equal to or above 400 A, or intended for use in complex systems in the second environment.

The variable speed drive complies with the product standard EN(IEC) 61800-3:2004 (Any kind of metal screened cable may be used). The standard variable speed drive is designed to meet the requirements according to category C3.

By using the optional “Extended EMC” filter the VSD fulfils requirements according to category C2,

**⚠ Warning** In a domestic environment this product may cause radio interference, in which case it may be necessary to take adequate additional measures.

**⚠ Warning** The standard VSD, complying with category C3, is not intended to be used on a low-voltage public network which supplies domestic premises; radio interference is expected if used in such a network. Contact your supplier if you need additional measures.

Table 1 Standards

Market	Standard	Description
European	EMC Directive	2004/108/EEC
	Low Voltage Directive	2006/95/EC
All	EN(IEC)61800-3:2004	Adjustable speed electrical power drive systems Part 3: EMC requirements and specific test methods. <b>EMC Directive: Declaration of Conformity and CE marking</b>
	EN(IEC)61800-5-1 Ed. 2.0	Adjustable speed electrical power drive systems Part 5-1. Safety requirements - Electrical, thermal and energy. <b>Low Voltage Directive: Declaration of Conformity and CE marking</b>
	IEC 60721-3-3	Classification of environmental conditions. Air quality chemical vapours, unit in operation. Chemical gases 3C1, Solid particles 3S2. Optional with coated boards Unit in operation. Chemical gases Class 3C2, Solid particles 3S2.
	UL508C	Contact your Omron representative
USA UL and UL	≥ 90 A only UL 840	Contact your Omron representative
Russian	GOST R	Contact your Omron representative

## 1-5 Dismantling and scrapping

The enclosures of the drives are made from recyclable material as aluminium, iron and plastic. Each drive contains a number of components demanding special treatment, for example electrolytic capacitors. The circuit boards contain small amounts of tin and lead. Any local or national regulations in force for the disposal and recycling of these materials must be complied with.

## 1-6 Glossary

### 1-6-1 Abbreviations and symbols

In this manual the following abbreviations are used:

Table 2 Abbreviations

Abbreviation/symbol	Description
DSP	Digital signals processor
VSD	Variable speed drive
PEBB	Power electronic building block
CP	Control panel, the programming and presentation unit on the VSD
EInt	Communication format
UInt	Communication format
Int	Communication format
Long	Communication format
	The function cannot be changed in run mode

### 1-6-2 Definitions

In this manual the following definitions for current, torque and frequency are used:

Table 3 Definitions

Name	Description	Quantity
$I_{IN}$	Nominal input current of VSD	$A_{RMS}$
$I_{NOM}$	Nominal output current of VSD	$A_{RMS}$
$I_{MOT}$	Nominal motor current	$A_{RMS}$
$P_{NOM}$	Nominal power of VSD	kW
$P_{MOT}$	Motor power	kW
$T_{NOM}$	Nominal torque of motor	Nm
$T_{MOT}$	Motor torque	Nm
$f_{OUT}$	Output frequency of VSD	Hz
$f_{MOT}$	Nominal frequency of motor	Hz
$n_{MOT}$	Nominal speed of motor	rpm
$I_{CL}$	Maximum output current	$A_{RMS}$
Speed	Actual motor speed	rpm
Torque	Actual motor torque	Nm
Sync speed	Synchronous speed of the motor	rpm



## SECTION 2 Mounting

This chapter describes how to mount the VSD.

Before mounting it is recommended that the installation is planned out first.

- Be sure that the VSD suits the mounting location.
- The mounting site must support the weight of the VSD.
- Will the VSD continuously withstand vibrations and/or shocks?
- Consider using a vibration damper.
- Check ambient conditions, ratings, required cooling air flow, compatibility of the motor, etc.
- Know how the VSD will be lifted and transported.

### 2-1 Lifting instructions

**Note** To prevent personal risks and any damage to the unit during lifting, it is advised that the lifting methods described below are used.

#### Models 4090 to 4132 and 6090 to 6250

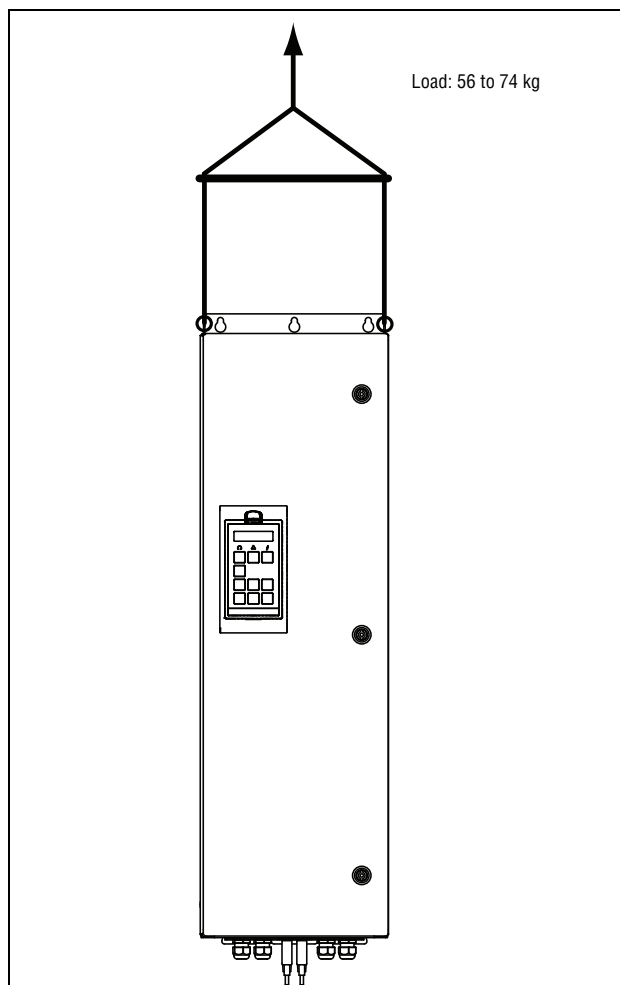

Fig. 3 Lifting model 4090-4132 and 6090-6250

Models 4160 to -4800 and 6315 to 61K0

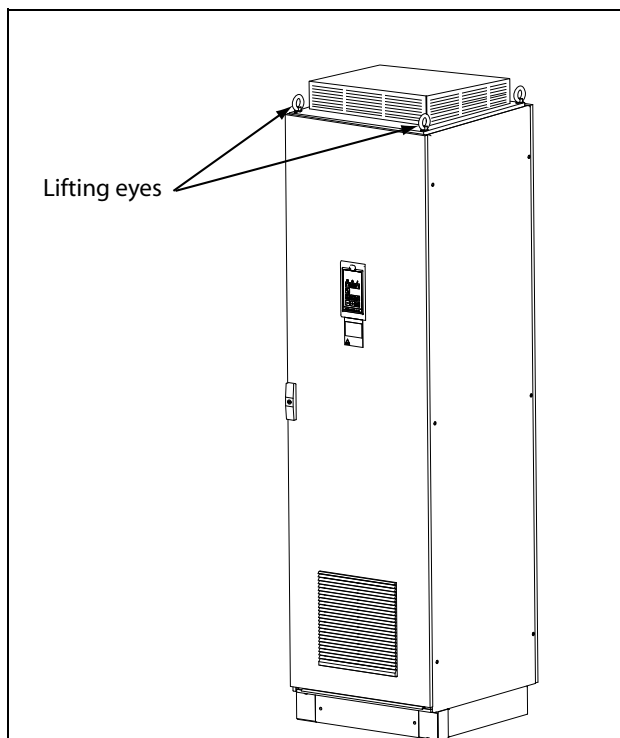

Fig. 4 Remove the roof plate and use the lifting eyes to lift.

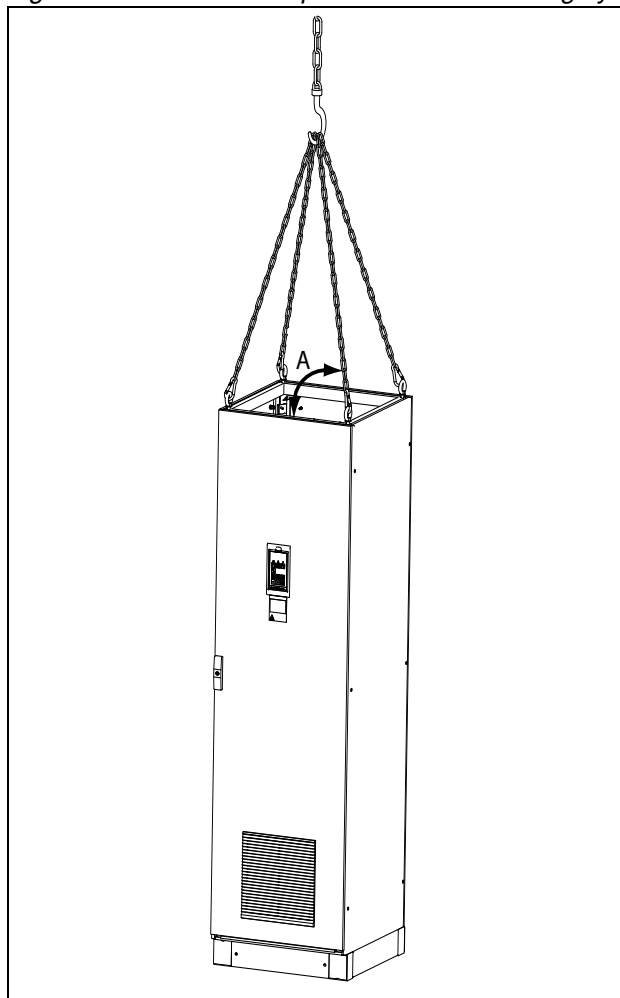

Fig. 5 Lifting VSD model 4160-4800 and 6315-61K0

Single drives can be lift/transported safely using the eyebolts supplied and lifting cables/chains as in illustration above.

Depending on the cable/chain angle A following load are permitted:

<b>Cable/Chain angle A</b>	<b>Permitted load</b>
45°	4800 N
60°	6400 N
90°	13600 N

## 2-2 Stand-alone units

The VSD must be mounted in a vertical position against a flat surface. Use the template (delivered together with the VSD) to mark out the position of the fixing holes.

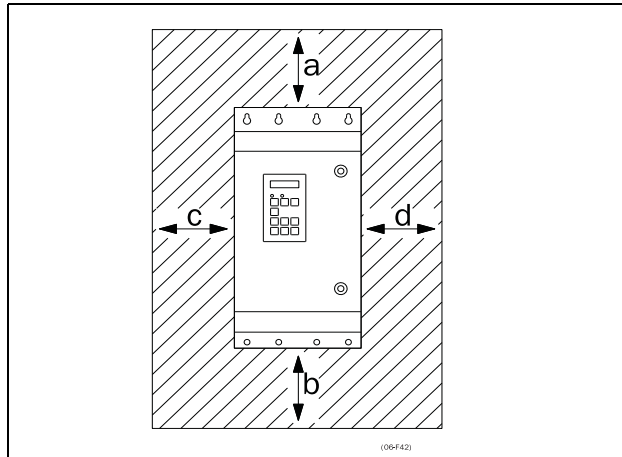

Fig. 6 Mounting models 4090-4800 and 6090-61K0

### 2-2-1 Cooling

Fig. 6 shows the minimum free space required around the VSD for the models 40P7-4800 and 6090-61K0 in order to guarantee adequate cooling. Because the fans blow the air from the bottom to the top it is advisable not to position an air inlet immediately above an air outlet.

The following minimum separation between two variable speed drives, or a VSD and a non-dissipating wall must be maintained. Valid if free space on opposite side.

Table 4 Mounting and cooling

		40P7-47P5	4011-4037	4045-4132 6090-6250	4160-4800 6315-61K0 cabinet
SX-F, side-by-side (mm)	a	200	200	200	100
	b	200	200	200	0
	c	0	0	0	0
	d	0	0	0	0
SX-F wall, wall-one side (mm)	a	100	100	100	100
	b	100	100	100	0
	c	0	0	0	0
	d	0	0	0	0

**Note** When a 4160-4800 or 6315-61K0 model is placed between two walls, a minimum distance at each side of 200 mm must be maintained.



2-2-2 Mounting schemes

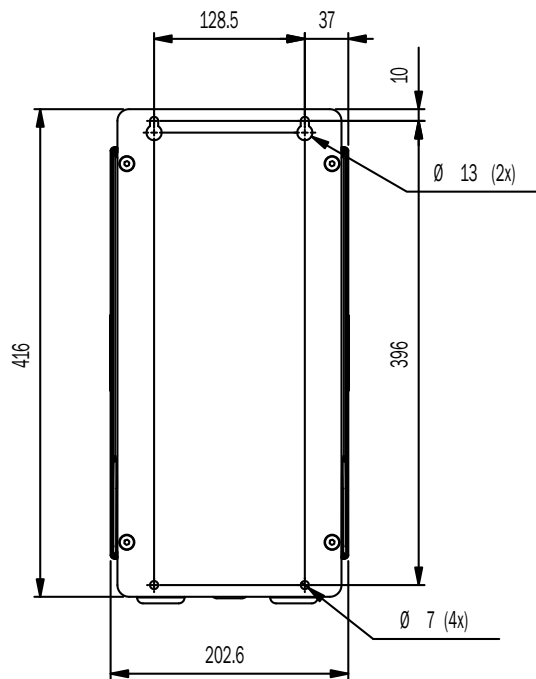

Fig. 7 SX-F: Model 40P7 to 47P5 (B)

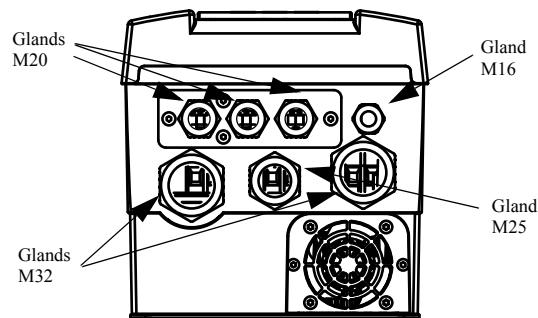

Fig. 8 SX-F: Model 40P7 to 47P5 (B) Cable interface for mains, motor and communication.

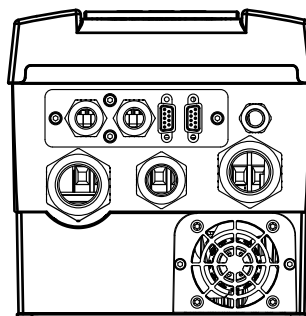

Fig. 9 SX-F: Model 40P7 to 47P5 (B) with optional gland plate

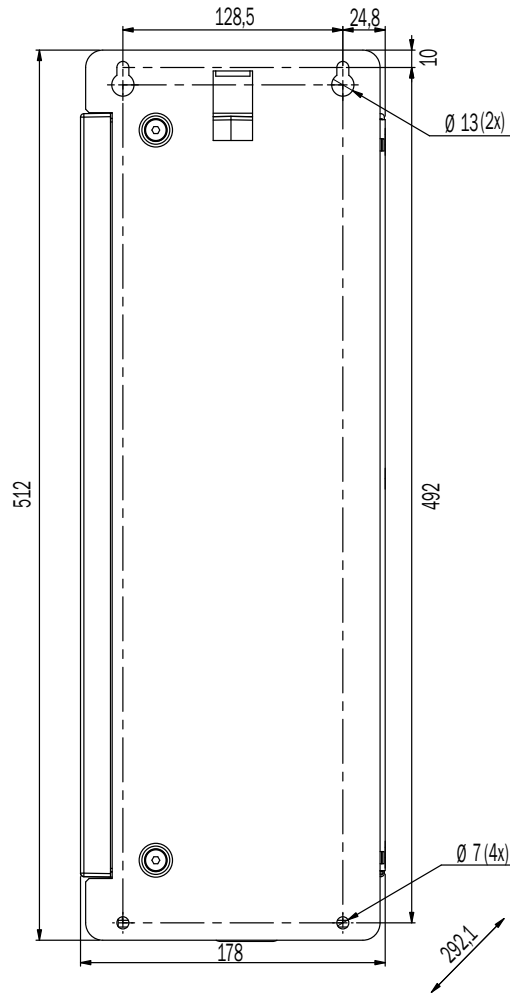

Fig. 10 SX-F: Model 4011 to 4022 (C)

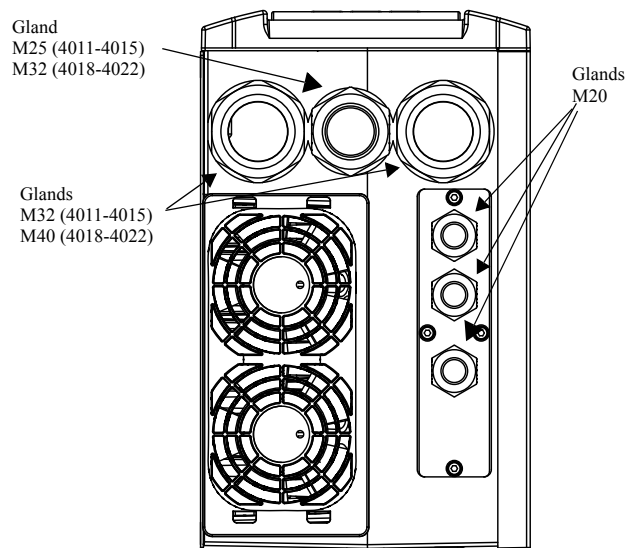

Fig. 11 SX-F: Model 4011 to 4022 (C) Cable interface for mains, motor and communication.

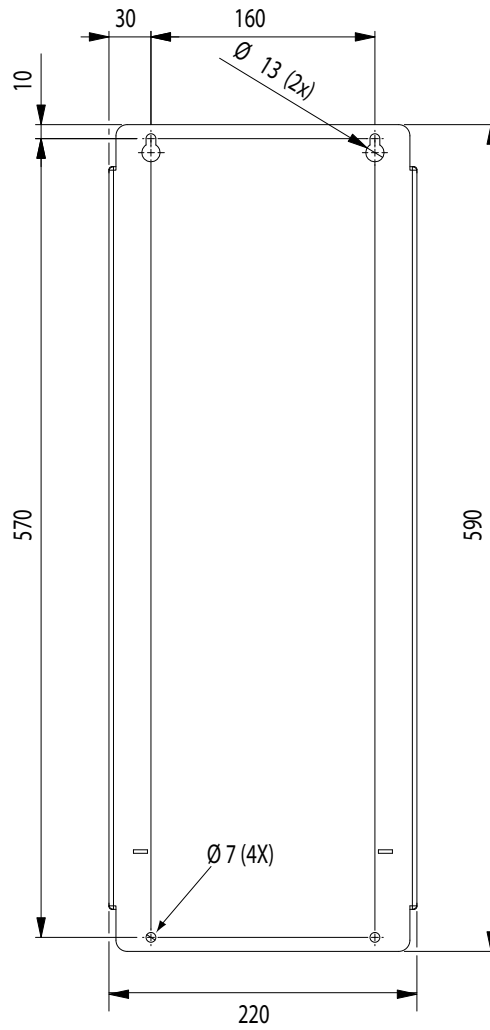

Fig. 12 SX-F: Model 4030 to 4037 (D)

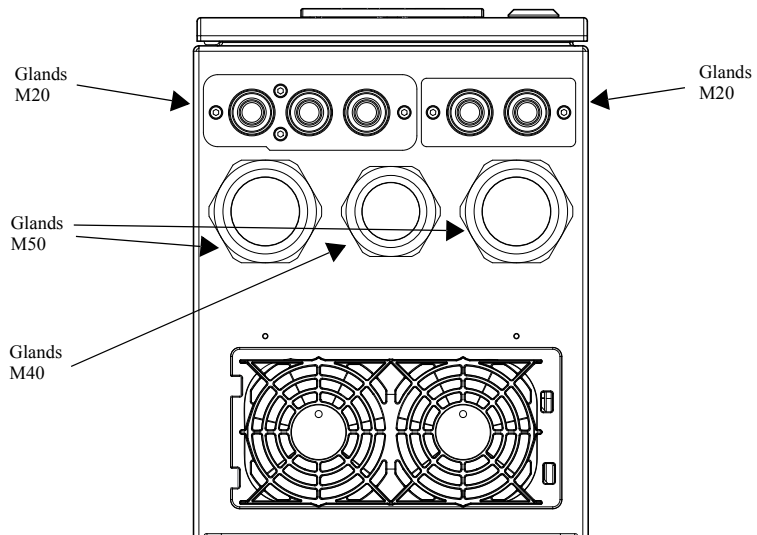

Fig. 13 SX-F: Model 4030 to 4037 (D) Cable interface for mains, motor and communication.

**Note** Glands for Models 40P7 to 4037 are available as option kit

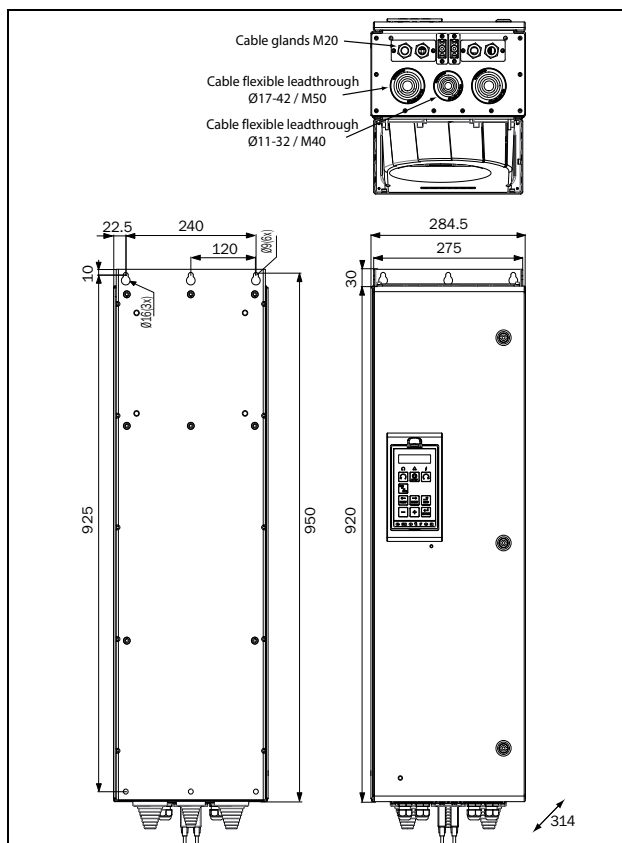

Fig. 14 SX-F (400V): Models 4045 to 4090 (E) including cable interface for mains, motor and communication

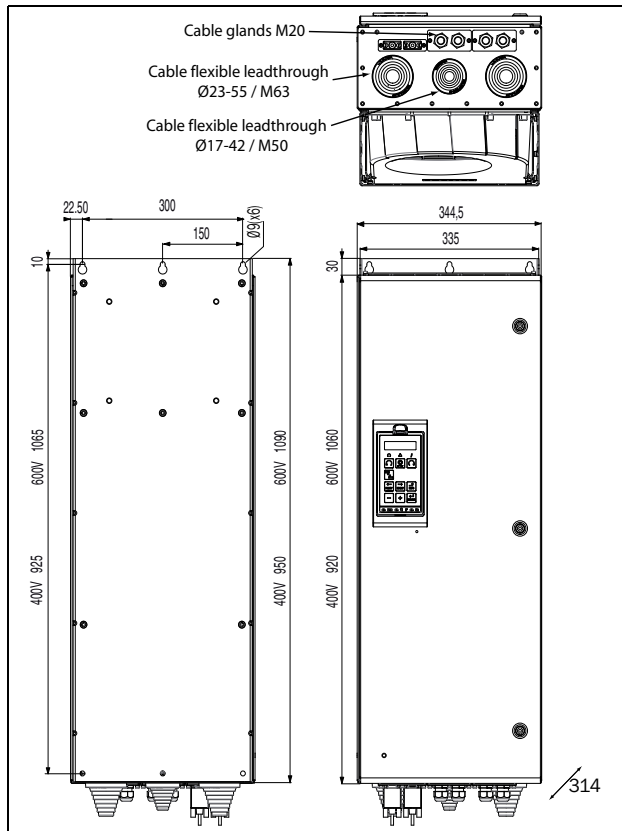

Fig. 15 SX-F (400V): Model 4110 to 4132 (F)  
SX-F(690V): Model 6090 to 6160 (F69) including cable interface for mains, motor and communication

## 2-3 Cabinet mounting

### 2-3-1 Cooling

If the variable speed drive is installed in a cabinet, the rate of airflow supplied by the cooling fans must be taken into consideration.

Table 5 Flow rates cooling fans

Frame	SX-F Model	Flow rate [m <sup>3</sup> /hour]
B	40P7 - 47P5	75
C	4011 - 4015	120
c	4018 - 4022	170
D	4030 - 4037	175
E	4045 - 4090	510
F	4110 - 4132	800
F69	6090 - 6160	
G	4160 - 4200	1020
H	4220 - 4250	1600
H69	6200 - 6355	
I	4315 - 4400	2400
I69	6450 - 6500	
J	4450 - 4500	3200
J69	6600 - 6630	
K	4630 - 4800	4800
K69	6710 - 61K0	

**Note** For the models 4450-4500 and 6800-61K0 the mentioned amount of air flow should be divided equally over the two cabinets.

### 2-3-2 Recommended free space in front of cabinet

All cabinet mounted AC drives are designed in modules, so called PEBBs. These PEBBs can be folded out to be replaced. To be able to remove a PEBB in the future, we recommend 1.30 meter free in front of the cabinet, see next figure for details.

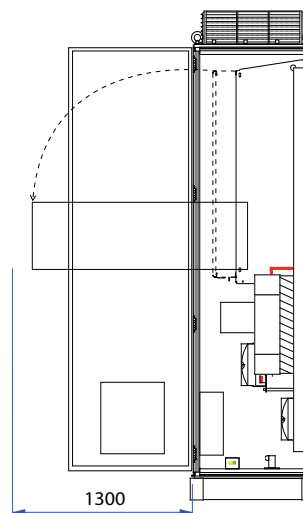

Fig. 16 Recommended free space in front of the cabinet mounted AC drive

### 2-3-3 Mounting schemes

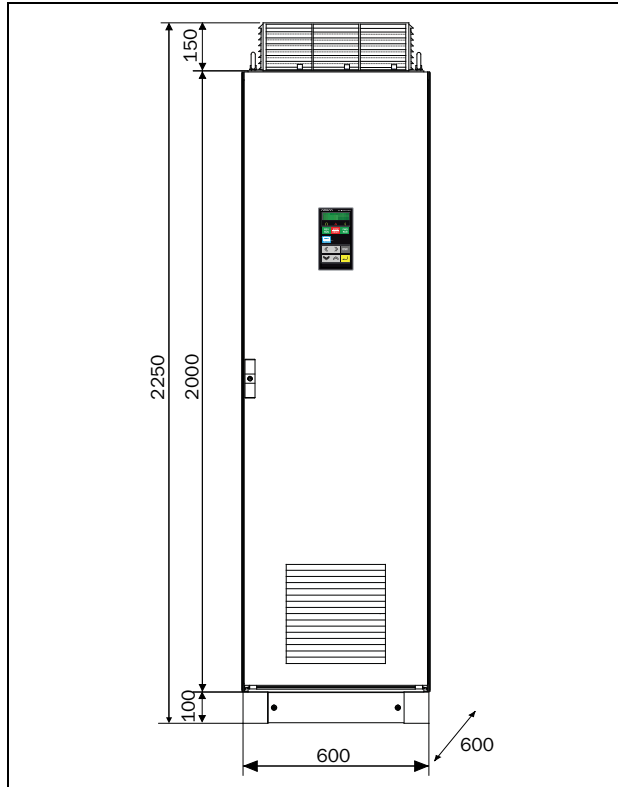

Fig. 17 SX-E1F (400V): Model 4160 to 4250 (G and H)  
SX-E1F (690V): Model 6200 to 6355 (H69)

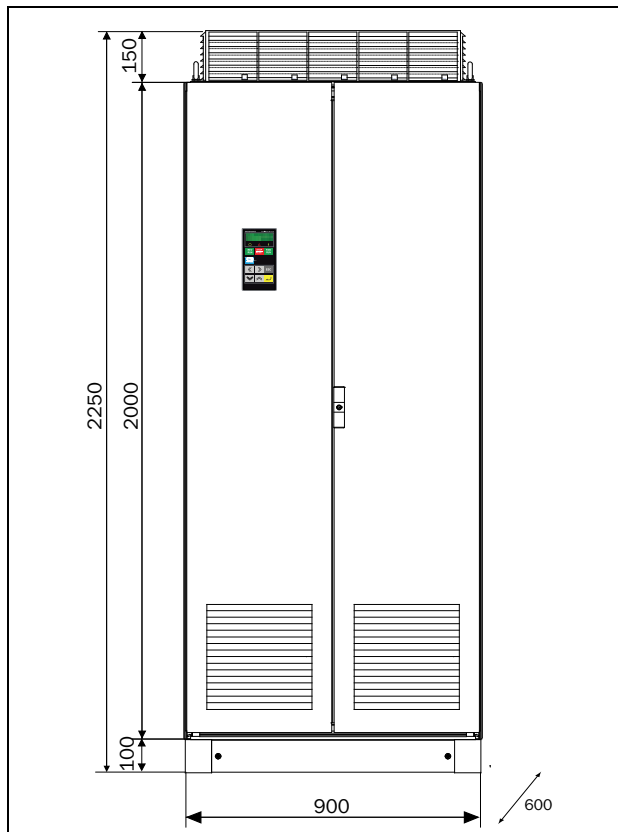

Fig. 18 SX-E1F (400V): Model 4315 to 4400 (I)  
SX-E1F (690V): Model 6450 to 6500 (I69)

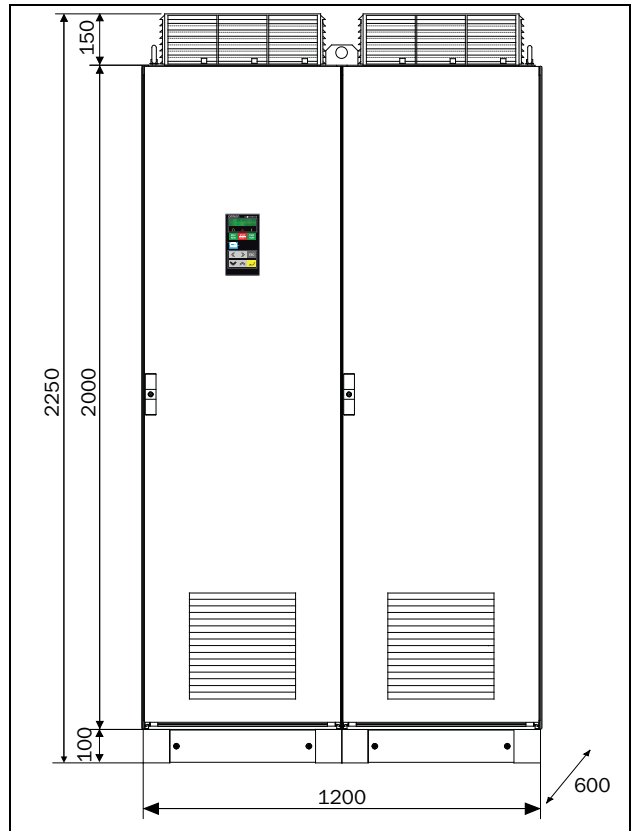

Fig. 19 SX-E1F (400V): Model 4450 to 4500 (J)  
SX-E1F (690V): Model 6600 to 6630 (J69)

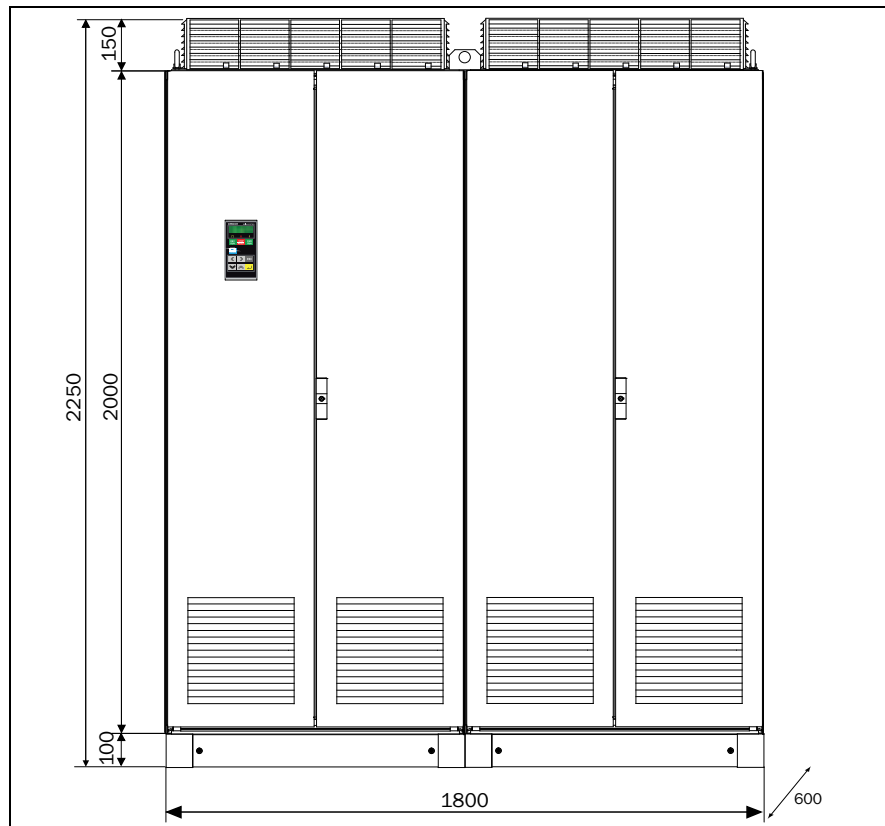

Fig. 20 SX-E1F (400V): Model 4630 to 4800 (K)  
SX-E1F (690V): Model 6710 to 61K0 (K69)





## SECTION 3

### Installation

The description of installation in this chapter complies with the EMC standards and the Machine Directive.

Select cable type and screening according to the EMC requirements valid for the environment where the VSD is installed.

#### 3-1 Before installation

Read the following checklist and think through your application before installation.

- External or internal control.
- Long motor cables (>100m), refer to section Long motor cables.
- Motors in parallel, refer to menu [213].
- Functions.
- Suitable VSD size in proportion to the motor/application.
- Mount separately supplied option boards according to the instructions in the appropriate option manual.

If the VSD is temporarily stored before being connected, please check the technical data for environmental conditions. If the VSD is moved from a cold storage room to the room where it is to be installed, condensation can form on it. Allow the VSD to become fully acclimatised and wait until any visible condensation has evaporated before connecting the mains voltage.

#### 3-2 Cable connections

##### 3-2-1 Mains cables

Dimension the mains and motor cables according to local regulations. The cable must be able to carry the VSD load current.

##### Recommendations for selecting mains cables

- To fulfil EMC purposes it is not necessary to use screened mains cables.
- Use heat-resistant cables, +60°C or higher.
- Dimension the cables and fuses in accordance with local regulations and the nominal current of the motor. See table 48, page 282.
- PE conductor cross-sectional area shall for cable size  $\leq 16\text{mm}^2$  be equal to the used phase conductors, for cable size above  $16\text{mm}^2$  but smaller or equal to  $35\text{mm}^2$  the PE conductor cross-sectional area shall be at least  $16\text{mm}^2$ . For cables  $> 35\text{mm}^2$  the PE conductor cross-sectional area should be at least 50% of the used phase conductor.
- When the PE conductor in the used cable type is not in accordance with the above mentioned cross-sectional area requirements, a separate PE conductor should be used to establish this.
- The litz ground connection see fig. 25, is only necessary if the mounting plate is painted. All the variable speed drives have an unpainted back side and are therefore suitable for mounting on an unpainted mounting plate.

Connect the mains cables according to the next figures. The VSD has as standard a built-in RFI mains filter that complies with category C3 which suits the Second Environment standard.

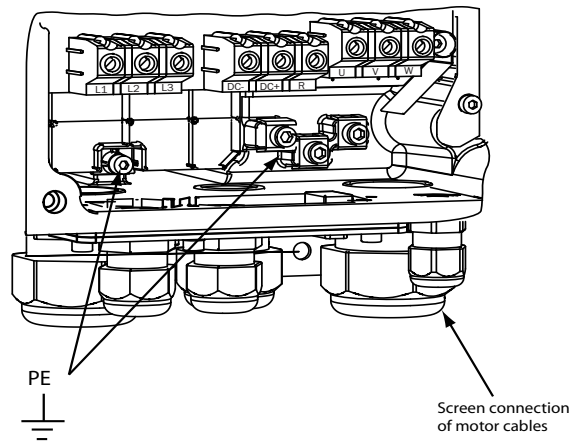

Fig. 21 Mains and motor connection 40P7 to 47P5

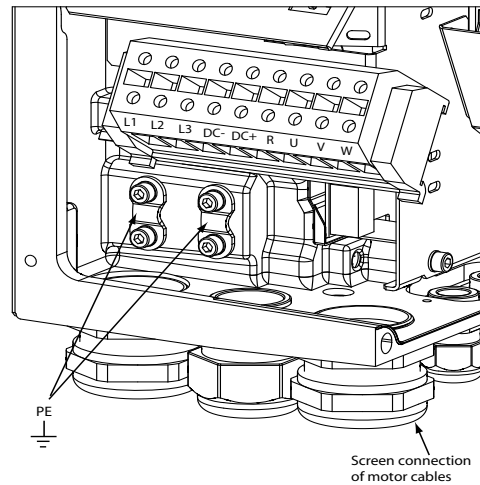

Fig. 22 Mains and motor connection 4011 to 4022

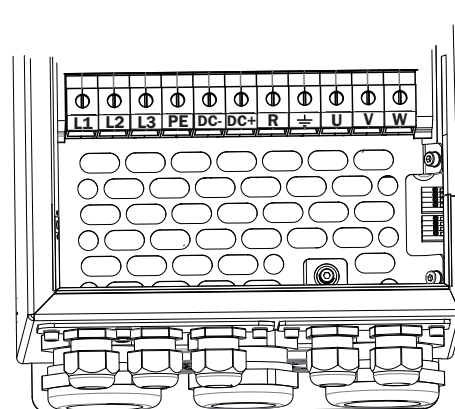

Fig. 23 Mains and motor connection 4030 to 4037

Table 6 Mains and motor connection

L1,L2,L3 PE	Mains supply, 3 -phase Safety earth (protected earth)
$\frac{\perp}{\text{—}}$ U, V, W	Motor earth Motor output, 3-phase
(DC-),DC+,R	Brake resistor, DC-link connections (optional)

**Note** The Brake and DC-link Terminals are only fitted if the Brake Chopper Option is built-in.

**Warning** The Brake Resistor must be connected between terminals DC+ and R.

**Warning** In order to work safely, the mains earth must be connected to PE and the motor earth to  $\perp$ .

### 3-2-2 Motor cables

To comply with the EMC emission standards the variable speed drive is provided with a RFI mains filter. The motor cables must also be screened and connected on both sides. In this way a so-called "Faraday cage" is created around the VSD, motor cables and motor. The RFI currents are now fed back to their source (the IGBTs) so the system stays within the emission levels.

#### Recommendations for selecting motor cables

- Use screened cables according to specification in table 7. Use symmetrical shielded cable; three phase conductors and a concentric or otherwise symmetrically constructed PE conductor, and a shield.
- PE conductor cross-sectional area shall for cable size  $\leq 16\text{mm}^2$  be equal to the used phase conductors, for cable size above  $16\text{mm}^2$  but smaller or equal to  $35\text{mm}^2$  the PE conductor cross-sectional area shall be at least  $16\text{mm}^2$ . For cables  $> 35\text{mm}^2$  the PE conductor cross-sectional area should be at least 50% of the used phase conductor.
- When the PE conductor in the used cable type is not in accordance with the above mentioned cross-sectional area requirements, a separate PE conductor should be used to establish this.
- When the conductivity of the cable PE conductor is  $< 50\%$  of the conductivity of the phase conductor, a separate PE conductor is required.
- Use heat-resistant cables,  $+60^\circ\text{C}$  or higher.
- Dimension the cables and fuses in accordance with the nominal output current of the motor. See table 48, page 282.
- Keep the motor cable between VSD and motor as short as possible.
- The screening must be connected with a large contact surface of preferable  $360^\circ$  and always at both ends, to the motor housing and the VSD housing. When painted mounting plates are used, do not be afraid to scrape away the paint to obtain as large contact surface as possible at all mounting points for items such as saddles and the bare cable screening. Relying just on the connection made by the screw thread is not sufficient.

**Note** It is important that the motor housing has the same earth potential as the other parts of the machine.

- The litz ground connection, see fig. 26, is only necessary if the mounting plate is painted. All the variable speed drives have an unpainted back side and are therefore suitable for mounting on an unpainted mounting plate.

Connect the motor cables according to U - U, V - V and W - W.

**Note** The terminals DC-, DC+ and R are options.

#### Switches between the motor and the VSD

If the motor cables are to be interrupted by maintenance switches, output coils, etc., it is necessary that the screening is continued by using metal housing, metal mounting plates, etc. as shown in the Fig. 25.

Fig. 26 shows an example when there is no metal mounting plate used (e.g. if IP54 variable speed drives are used). It is important to keep the “circuit” closed, by using metal housing and cable glands.

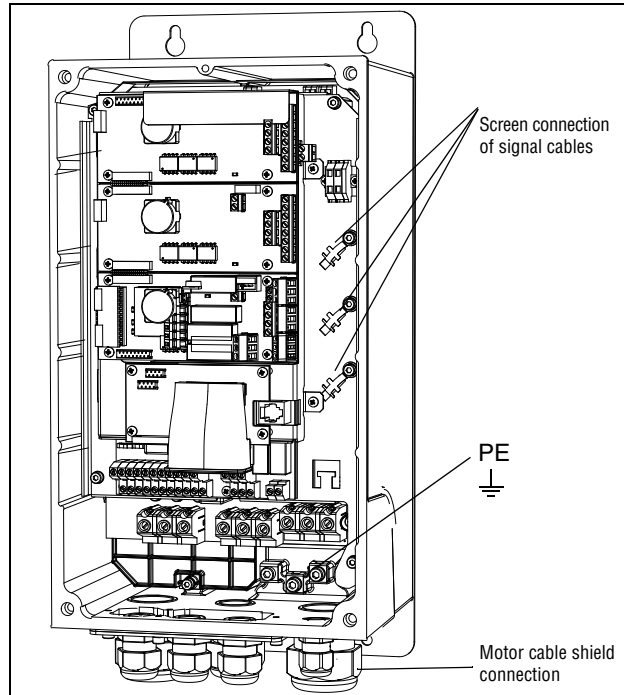

Fig. 24 Screen connection of cables.

Pay special attention to the following points:

- If paint must be removed, steps must be taken to prevent subsequent corrosion. Repaint after making connections!
- The fastening of the whole variable speed drive housing must be electrically connected with the mounting plate over an area which is as large as possible. For this purpose the removal of paint is necessary. An alternative method is to connect the variable speed drive housing to the mounting plate with as short a length of litz wire as possible.
- Try to avoid interruptions in the screening wherever possible.
- If the variable speed drive is mounted in a standard cabinet, the internal wiring must comply with the EMC standard. Fig. 25 shows an example of a VSD built into a cabinet.

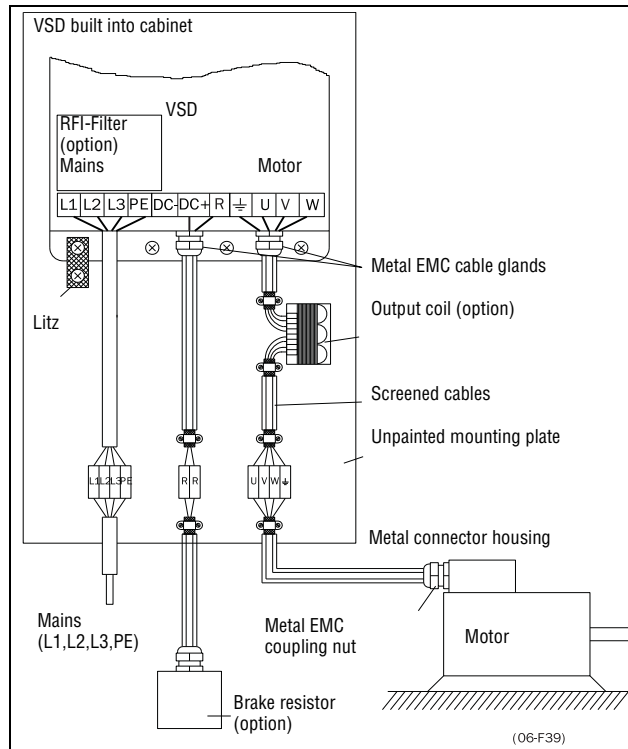

Fig. 25 Variable speed drive in a cabinet on a mounting plate

Fig. 26 shows an example when there is no metal mounting plate used (e.g. if IP54 variable speed drives are used). It is important to keep the “circuit” closed, by using metal housing and cable glands.

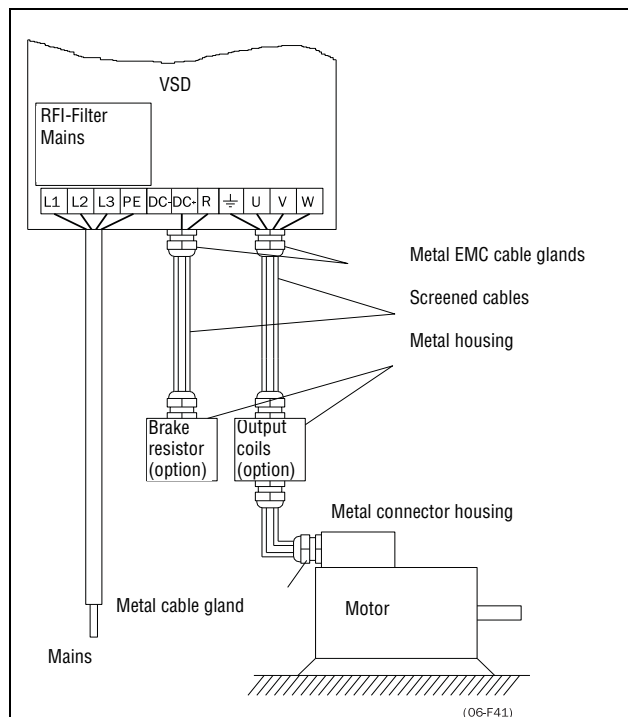

Fig. 26 Variable speed drive as stand alone

**Connect motor cables**

1. Remove the cable interface plate from the VSD housing.
2. Put the cables through the glands.
3. Strip the cable according to Table 8.
4. Connect the stripped cables to the respective motor terminal.
5. Put the cable interface plate in place and secure with the fixing screws.
6. Tighten the EMC gland with good electrical contact to the motor and brake chopper cable screens.

**Placing of motor cables**

Keep the motor cables as far away from other cables as possible, especially from control signals. The minimum distance between motor cables and control cables is 300 mm.

Avoid placing the motor cables in parallel with other cables.

The power cables should cross other cables at an angle of 90°.

**Long motor cables**

If the connection to the motor is longer than 100 m (40 m for models 003-018), it is possible that capacitive current peaks will cause tripping at overcurrent. Using output coils can prevent this. Contact the supplier for appropriate coils.

**Switching in motor cables**

Switching in the motor connections is not advisable. In the event that it cannot be avoided (e.g. emergency or maintenance switches) only switch if the current is zero. If this is not done, the VSD can trip as a result of current peaks.

### 3-3 Connect motor and mains cables

#### SX-D4045-EF to SX-D4132-EF and SX-D6090-EF to SX-D6160-EF

To simplify the connection of thick motor and mains cables to the VSD model SX-D4045-EF to SX-D4132-EF and SX-D6090-EF to SX-D6160-EF the cable interface plate can be removed.

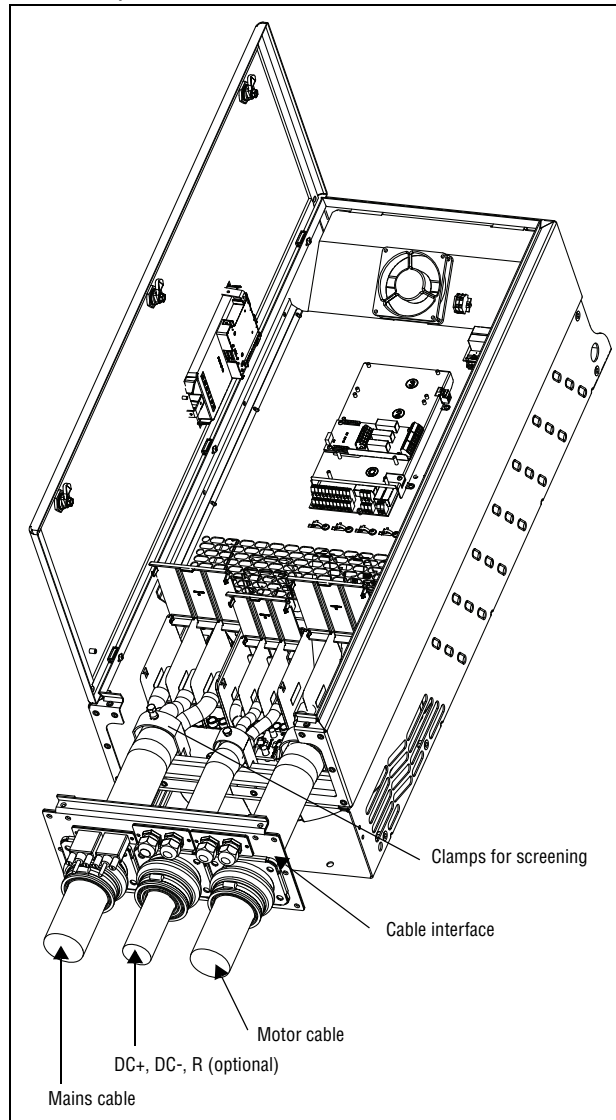
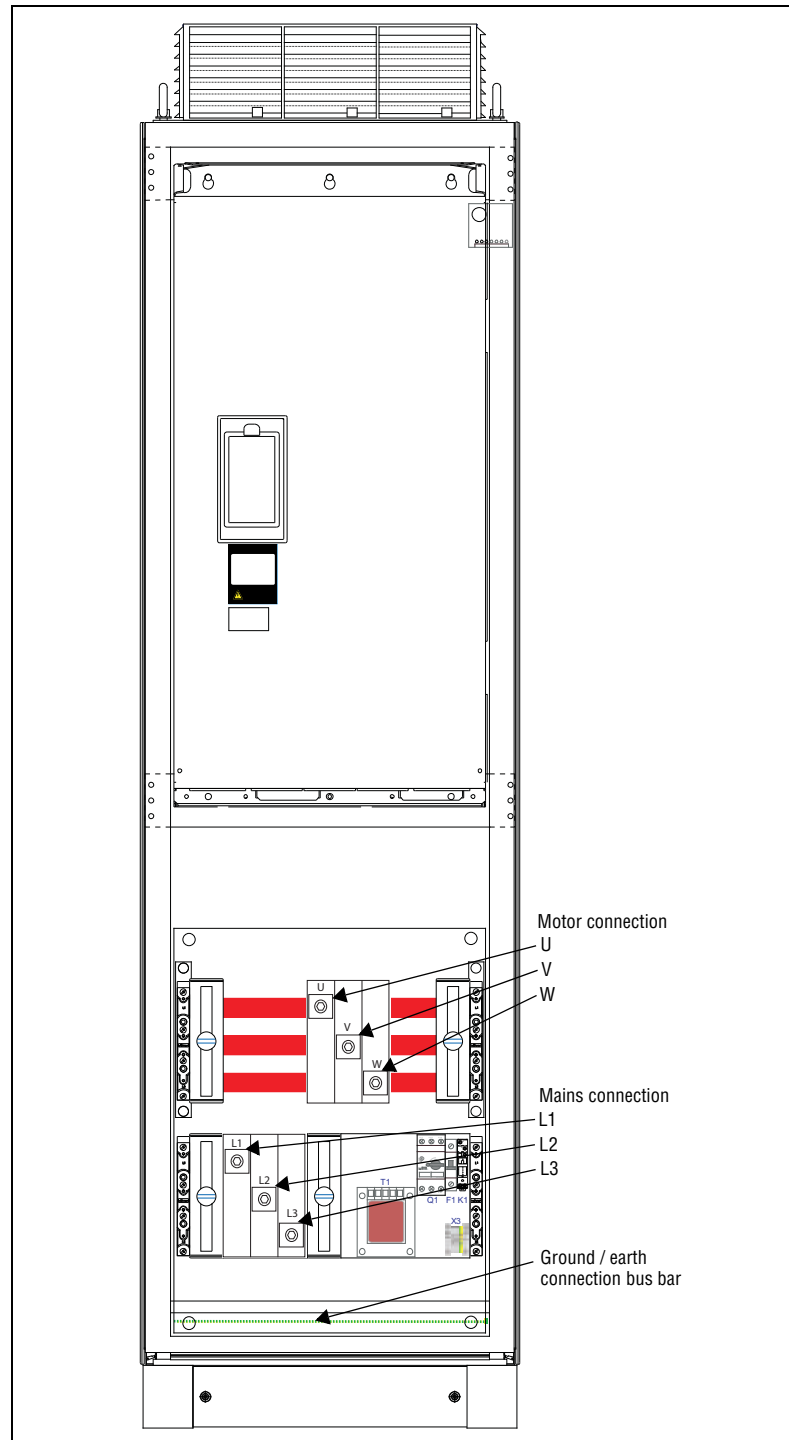

Fig. 27 Connecting motor and mains cables

1. Remove the cable interface plate from the VSD housing.
2. Put the cables through the glands.
3. Strip the cable according to Table 8.
4. Connect the stripped cables to the respective mains/motor terminal.
5. Fix the clamps on appropriate place and tighten the cable in the clamp with good electrical contact to the cable screen.
6. Put the cable interface plate in place and secure with the fixing screws.

**SX-D4160-EF to SX-D4800-EF and SX-D6200-EF to SX-D61K0-EF**



*Fig. 28 Connecting motor and mains cables*

VSD models SX-D4160-EF to SX-D4800-EF and SX-D6200-EF to SX-D61K0-EF are supplied with power clamps for mains and motors. For connection of the PE and earth there is a bus bar.

For all type of wires to be connected the stripping length should be 32 mm.



### 3-3-1 Connection of mains and motor cables on IP20 modules

The IP20 modules are delivered complete with factory mounted cable for mains and motor. The length of the cables are app. 1100mm. The cables are marked as L1, L2, L3 for mains connection and U, V, W for motor connection.

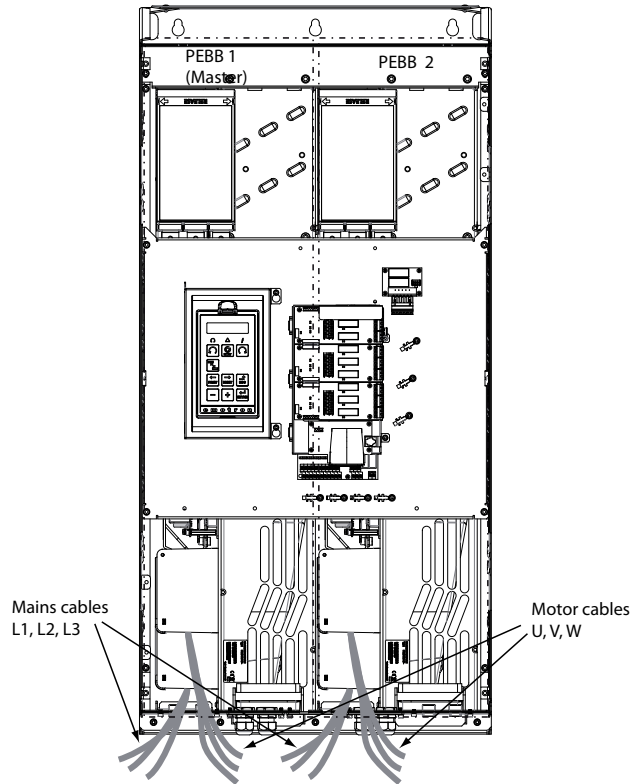

Fig. 29 IP20 module size G with quantity 2x3 main cables and quantity 2x3 motor cables.

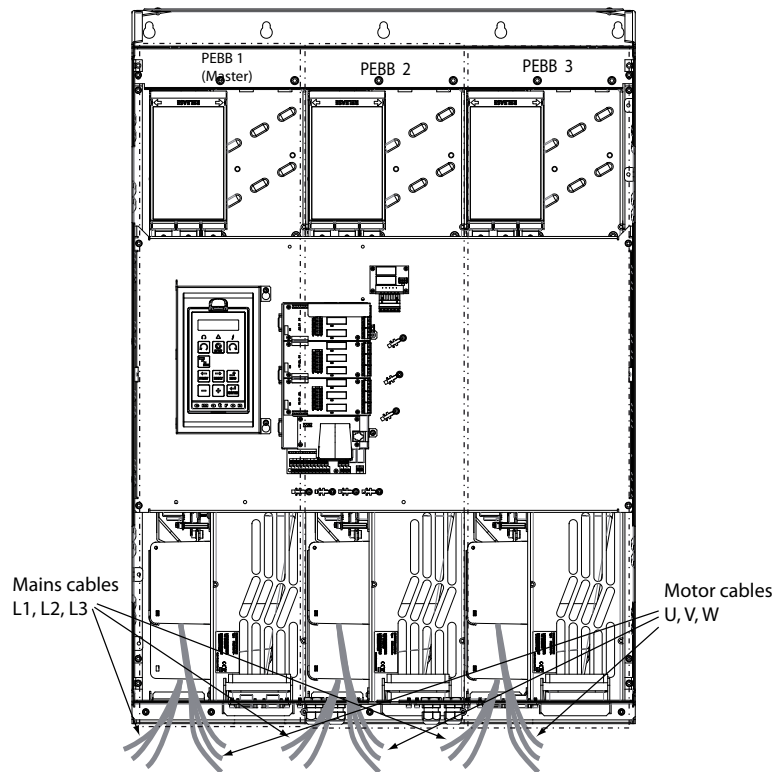

Fig. 30 IP20 module size H/H69 with quantity 3x3 main cables and quantity 3x3 motor cables.

## 3-4 Cable specifications

Table 7 Cable specifications

Cable	Cable specification
Mains	Power cable suitable for fixed installation for the voltage used.
Motor	Symmetrical three conductor cable with concentric protection (PE) wire or a four conductor cable with compact low-impedance concentric shield for the voltage used.
Control	Control cable with low-impedance shield, screened.

## 3-5 Stripping lengths

Fig. 31 indicates the recommended stripping lengths for motor and mains cables.

Table 8 Stripping lengths for mains and motor cables

Model	Mains cable		Motor cable		
	a (mm)	b (mm)	a (mm)	b (mm)	c (mm)
SX-D40P7-EF to SX-D47P5-EF	90	10	90	10	20
SX-D4011-EF to SX-D4022-EF	150	14	150	14	20
SX-D4030-EF to SX-D4037-EF	110	17	110	17	34
SX-D4045-EF to SX-D4090-EF	160	16	160	16	41
SX-D4110-EF to SX-D4132-EF SX-D6090-EF to SX-D6160-EF	170	24	170	24	46

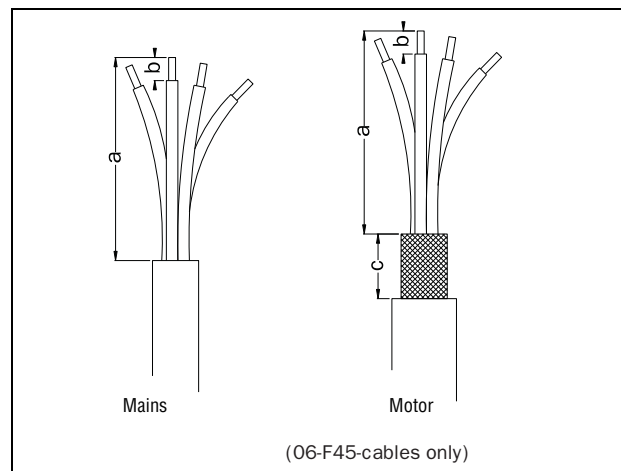

Fig. 31 Stripping lengths for cables

### 3-5-1 Dimension of cables and fuses

Please refer to the chapter Technical data, section 14-6, page 282.

### 3-5-2 Tightening torque for mains and motor cables

Table 9 Model SX-D40P7-EF to SX-D4022-EF

	Brake chopper	Mains/motor
Tightening torque, Nm	1.2 - 1.4	1.2 - 1.4

Table 10 Model SX-D4030-EF

	Brake chopper	Mains/motor
Tightening torque, Nm	2.8	2.8

Table 11 Model SX-D4037-EF

	Brake chopper	Mains/motor
Tightening torque, Nm	5.0	5.0

Table 12 Model SX-D4045-EF to SX-D4055-EF

	Brake chopper	Mains/motor
Block, mm <sup>2</sup>	95	95
Cable diameter, mm <sup>2</sup>	16-95	16-95
Tightening torque, Nm	14	14

Table 13 Model SX-D4075-EF to SX-D4090-EF

	Brake chopper	Mains/motor	
Block, mm <sup>2</sup>	95	150	
Cable diameter, mm <sup>2</sup>	16-95	35-95	120-150
Tightening torque, Nm	14	14	24

Table 14 Model SX-D4110-EF to SX-D4132-EF and SX-D6090-EF to SX-D6160-EF

	Brake chopper		Mains/motor	
Block, mm <sup>2</sup>	150		240	
Cable diameter, mm <sup>2</sup>	35-95	120-150	35-70	95-240
Tightening torque, Nm	14	24	14	24

### 3-6 Thermal protection on the motor

Standard motors are normally fitted with an internal fan. The cooling capacity of this built-in fan is dependent on the frequency of the motor. At low frequency, the cooling capacity will be insufficient for nominal loads. Please contact the motor supplier for the cooling characteristics of the motor at lower frequency.

**⚠ Warning** Depending on the cooling characteristics of the motor, the application, the speed and the load, it may be necessary to use forced cooling on the motor.

Motor thermistors offer better thermal protection for the motor. Depending on the type of motor thermistor fitted, the optional PTC input may be used. The motor thermistor gives a thermal protection independent of the speed of the motor, thus of the speed of the motor fan. See the functions, Motor I<sup>2</sup>t type [231] and Motor I<sup>2</sup>t current [232].

### 3-7 Motors in parallel

It is possible to have motors in parallel as long as the total current does not exceed the nominal value of the VSD. The following has to be taken into account when setting the motor data:

Menu [221] Motor Voltage:	The motors in parallel must have the same motor voltage.
Menu [222] Motor Frequency:	The motors in parallel must have the same motor frequency.
Menu [223] Motor Power:	Add the motor power values for the motors in parallel.

Menu [224] Motor Current:	Add the current for the motors in parallel.
Menu [225] Motor Speed:	Set the average speed for the motors in parallel.
Menu [227] Motor Cos PHI:	Set the average Cos PHI value for the motors in parallel.

**Note** The shafts of the motors in parallel must be physically connected to obtain correct torque and speed control.

## SECTION 4 Getting Started

This chapter is a step by step guide that will show you the quickest way to get the motor shaft turning. We will show you two examples, remote control and local control.

We assume that the VSD is mounted on a wall or in a cabinet as in the chapter SECTION 2 page 13.

First there is general information of how to connect mains, motor and control cables. The next section describes how to use the function keys on the control panel. The subsequent examples covering remote control and local control describe how to program/set the motor data and run the VSD and motor.

### 4-1 Connect the mains and motor cables

Dimension the mains and motor cables according to local regulations. The cable must be able to carry the VSD load current.

#### 4-1-1 Mains cables

1. Connect the mains cables as in Fig. 32. The VSD has, as standard, a built-in RFI mains filter that complies with category C3 which suits the Second Environment standard.

#### 4-1-2 Motor cables

2. Connect the motor cables as in Fig. 32. To comply with the EMC Directive you have to use screened cables and the motor cable screen has to be connected on both sides: to the housing of the motor and the housing of the VSD.

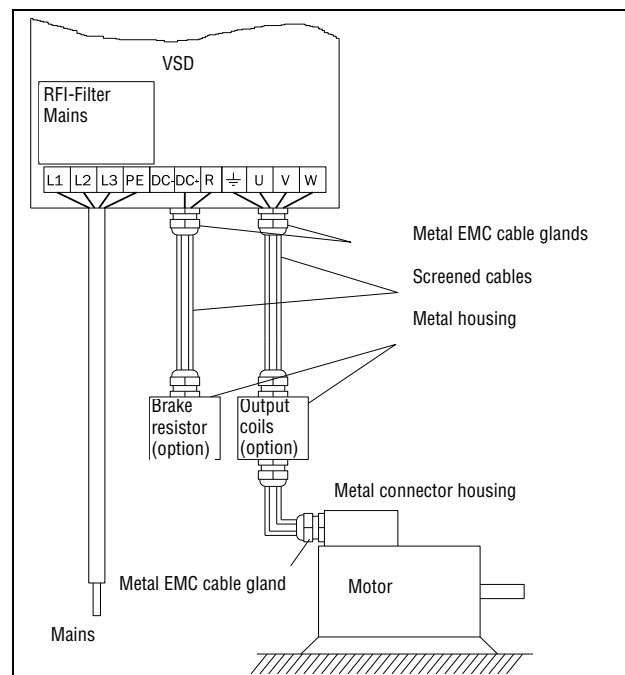

Fig. 32 Connection of mains and motor cables

Table 15 Mains and motor connection

L1,L2,L3 PE	Mains supply, 3 -phase Safety earth
$\perp$ U, V, W	Motor earth Motor output, 3-phase

**Warning** In order to work safely the mains earth must be connected to PE and the motor earth to  $\perp$ .

## 4-2 Using the function keys

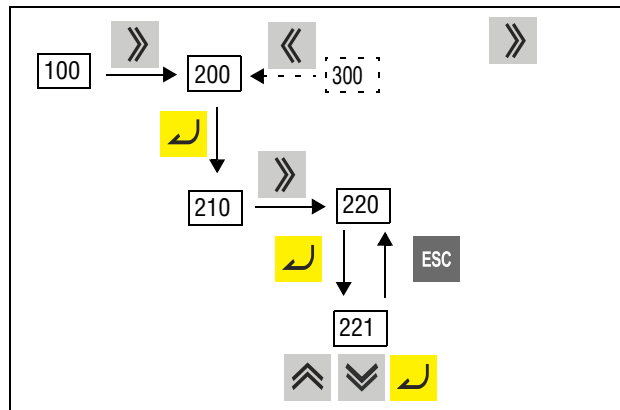

Fig. 33 Example of menu navigation when entering motor voltage



step to lower menu level or confirm changed setting



step to higher menu level or ignore changed setting



step to next menu on the same level



step to previous menu on the same level



increase value or change selection



decrease value or change selection

## 4-3 Remote control

In this example external signals are used to control the VSD/motor.

A standard 4-pole motor for 400 V, an external start button and a reference value will also be used.

### 4-3-1 Connect control cables

Here you will make up the minimum wiring for starting. In this example the motor/VSD will run with right rotation.

To comply with the EMC standard, use screened control cables with plaited flexible wire up to 1.5 mm<sup>2</sup> or solid wire up to 2.5 mm<sup>2</sup>.

3. Connect a reference value between terminals 7 (Common) and 2 (AnIn 1) as in Fig. 34.
4. Connect an external start button between terminal 11 (+24 VDC) and 9 (DigIn2, RUNR) as in Fig. 34.

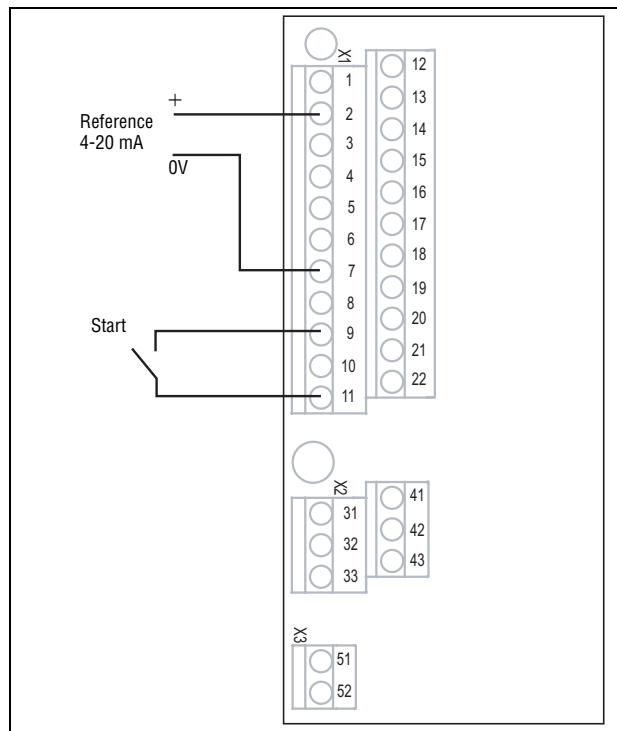

Fig. 34 Wiring

### 4-3-2 Switch on the mains

Once the mains is switched on, the internal fan in the VSD will run for 5 seconds.

### 4-3-3 Set the Motor Data

Enter correct motor data for the connected motor. The motor data is used in the calculation of complete operational data in the VSD.

Change settings using the keys on the control panel. For further information about the control panel and menu structure, see the chapter SECTION 9 page 67.

Menu [100], Preferred View is displayed when started.

1. Press **»** to display menu [200], Main Setup.
2. Press **↵** and then **»** to display menu [220], Motor Data.
3. Press **↵** to display menu [221] and set motor voltage.
4. Change the value using the **⬆** and **⬇** keys. Confirm with **↵**.
5. Set motor frequency [222].
6. Set motor power [223].
7. Set motor current [224].
8. Set motor speed [225].
9. Set power factor ( $\cos \varphi$ ) [227].
10. Select supply voltage level used [21B]
11. [229] Motor ID run: Choose Short, confirm with **↵** and give start command **▶**.

The VSD will now measure some motor parameters. The motor makes some beeping sounds but the shaft does not rotate. When the ID run is finished after about one minute ("Test Run OK!" is displayed), press **STOP RESET** to continue.

12. Use AnIn1 as input for the reference value. The default range is 4-20 mA. If you need a 0-10 V reference value, change switch (S1) on control board.

13. Switch off power supply.
14. Connect digital and analogue inputs/outputs as in Fig. 34.
15. Ready!
16. Switch on power supply.

#### 4-3-4 Run the VSD

Now the installation is finished, and you can press the external start button to start the motor.

When the motor is running the main connections are OK.

### 4-4 Local control

Manual control via the control panel can be used to carry out a test run.











Use a 400 V motor and the control panel.

#### 4-4-1 Switch on the mains

Once the mains is switched on, the VSD is started and the internal fan will run for 5 seconds.







#### 4-4-2 Select manual control

Menu [100], Preferred View is displayed when started.

1. Press  to display menu [200], Main Setup.
2. Press  to display menu [210], Operation.
3. Press  to display menu [211], Language.
4. Press  to display menu [214], Reference Control.
5. Select Keyboard using the key  and press  to confirm.
6. Press  to get to menu [215], Run/Stop Control.
7. Select Keyboard using the key  and press  to confirm.
8. Press  to get to previous menu level and then  to display menu [220], Motor Data.





#### 4-4-3 Set the Motor Data

Enter correct motor data for the connected motor.

9. Press  to display menu [221].
10. Change the value using the  and  keys. Confirm with .
11. Press  to display menu [222].
12. Repeat step 9 and 10 until all motor data is entered.
13. Press  twice and then  to display menu [100], Preferred View.

#### 4-4-4 Enter a Reference Value

Enter a reference value.

14. Press  until menu [300], Process is displayed.
15. Press  to display menu [310], Set/View reference value.
16. Use the  and  keys to enter, for example, 300 rpm. We select a low value to check the rotation direction without damaging the application.

#### 4-4-5 Run the VSD

Press the  key on the control panel to run the motor forward.

If the motor is running the main connections are OK.



# SECTION 5

## Control Connections

### 5-1 Control board

Fig. 35 shows the layout of the control board which is where the parts most important to the user are located. Although the control board is galvanically isolated from the mains, for safety reasons do not make changes while the mains supply is on!

**⚠ Warning** Always switch off the mains voltage and wait at least 7 minutes to allow the DC capacitors to discharge before connecting the control signals or changing position of any switches. If the option External supply is used, switch of the mains to the option. This is done to prevent damage on the control board.

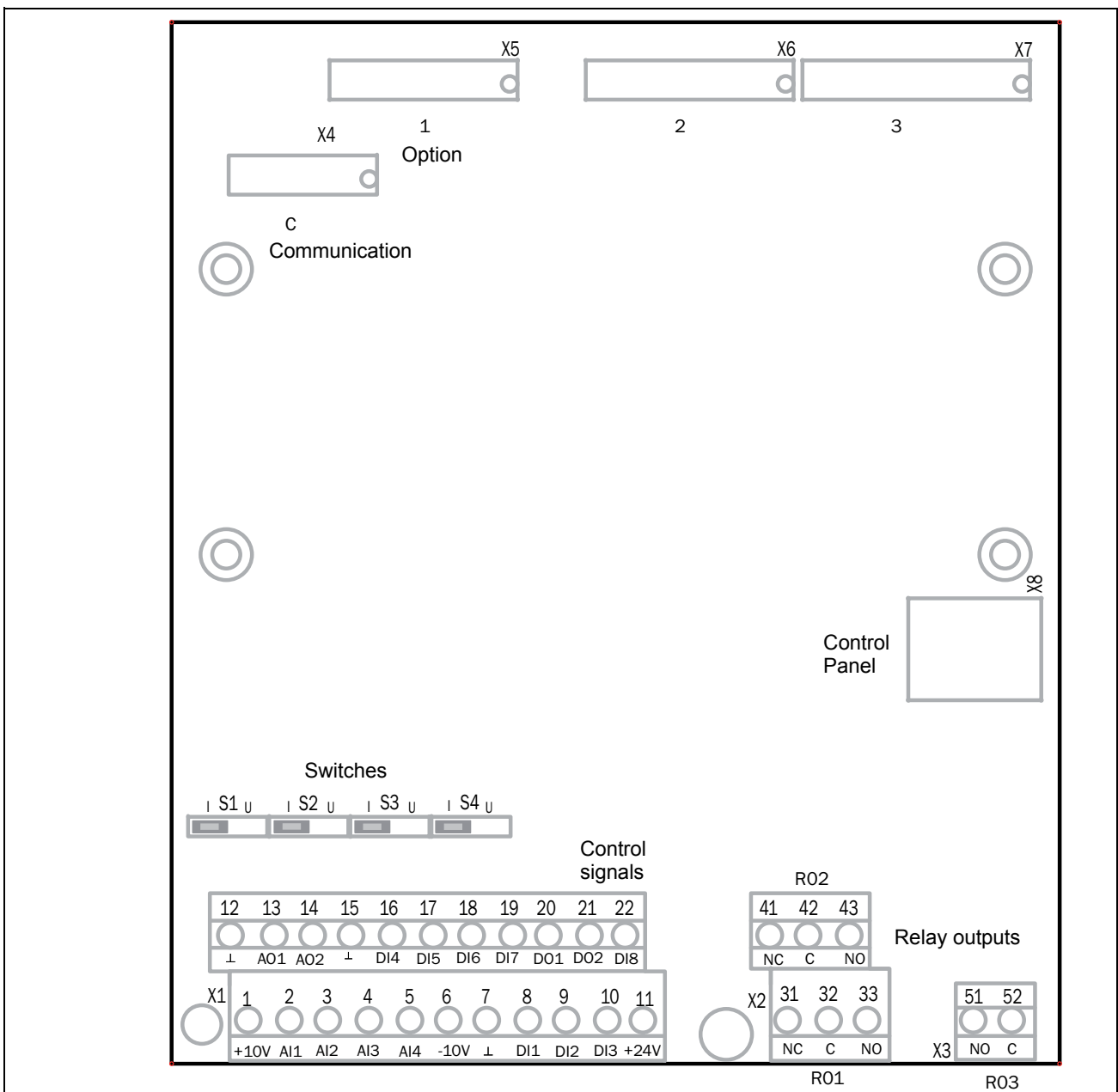

Fig. 35 Control board layout

## 5-2 Terminal connections

The terminal strip for connecting the control signals is accessible after opening the front panel.

The table describes the default functions for the signals. The inputs and outputs are programmable for other functions as described in chapter SECTION 11 page 83. For signal specifications refer to chapter SECTION 14 page 277.

**Note** The maximum total combined current for outputs 11, 20 and 21 is 100mA.

Table 16 Control signals

Terminal	Name	Function (Default)
<b>Outputs</b>		
1	+10 V	+10 VDC supply voltage
6	-10 V	-10 VDC supply voltage
7	Common	Signal ground
11	+24 V	+24 VDC supply voltage
12	Common	Signal ground
15	Common	Signal ground
<b>Digital inputs</b>		
8	DigIn 1	RunL (reverse)
9	DigIn 2	RunR (forward)
10	DigIn 3	Off
16	DigIn 4	Off
17	DigIn 5	Off
18	DigIn 6	Off
19	DigIn 7	Off
22	DigIn 8	RESET
<b>Digital outputs</b>		
20	DigOut 1	Ready
21	DigOut 2	Brake
<b>Analogue inputs</b>		
2	AnIn 1	Process Ref
3	AnIn 2	Off
4	AnIn 3	Off
5	AnIn 4	Off
<b>Analogue outputs</b>		
13	AnOut1	Min speed to max speed
14	AnOut2	0 to max torque
<b>Relay outputs</b>		
31	N/C 1	Relay 1 output Trip, active when the VSD is in a TRIP condition.
32	COM 1	
33	N/O 1	
41	N/C 2	Relay 2 output Run, active when the VSD is started.
42	COM 2	
43	N/O 2	

Table 16 Control signals









Terminal	Name	Function (Default)
51	COM 3	Relay 3 output
52	N/O 3	Off

**Note** N/C is opened when the relay is active and N/O is closed when the relay is active.

### 5-3 Inputs configuration with the switches

The switches S1 to S4 are used to set the input configuration for the 4 analogue inputs AnIn1, AnIn2, AnIn3 and AnIn4 as described in table 17. See Fig. 35 for the location of the switches.

Table 17 Switch settings

Input	Signal type	Switch
<b>AnIn1</b>	Voltage	S1 
	Current (default)	S1 
<b>AnIn2</b>	Voltage	S2 
	Current (default)	S2 
<b>AnIn3</b>	Voltage	S3 
	Current (default)	S3 
<b>AnIn4</b>	Voltage	S4 
	Current (default)	S4 

**Note** Scaling and offset of AnIn1 - AnIn4 can be configured using the software. See menus [512], [515], [518] and [51B] in section 11-5, page 187.

**Note** The 2 analogue outputs AnOut 1 and AnOut 2 can be configured using the software. See menu [530] section 11-5-3, page 201.

# 5-4 Connection example

Fig. 36 gives an overall view of a VSD connection example.

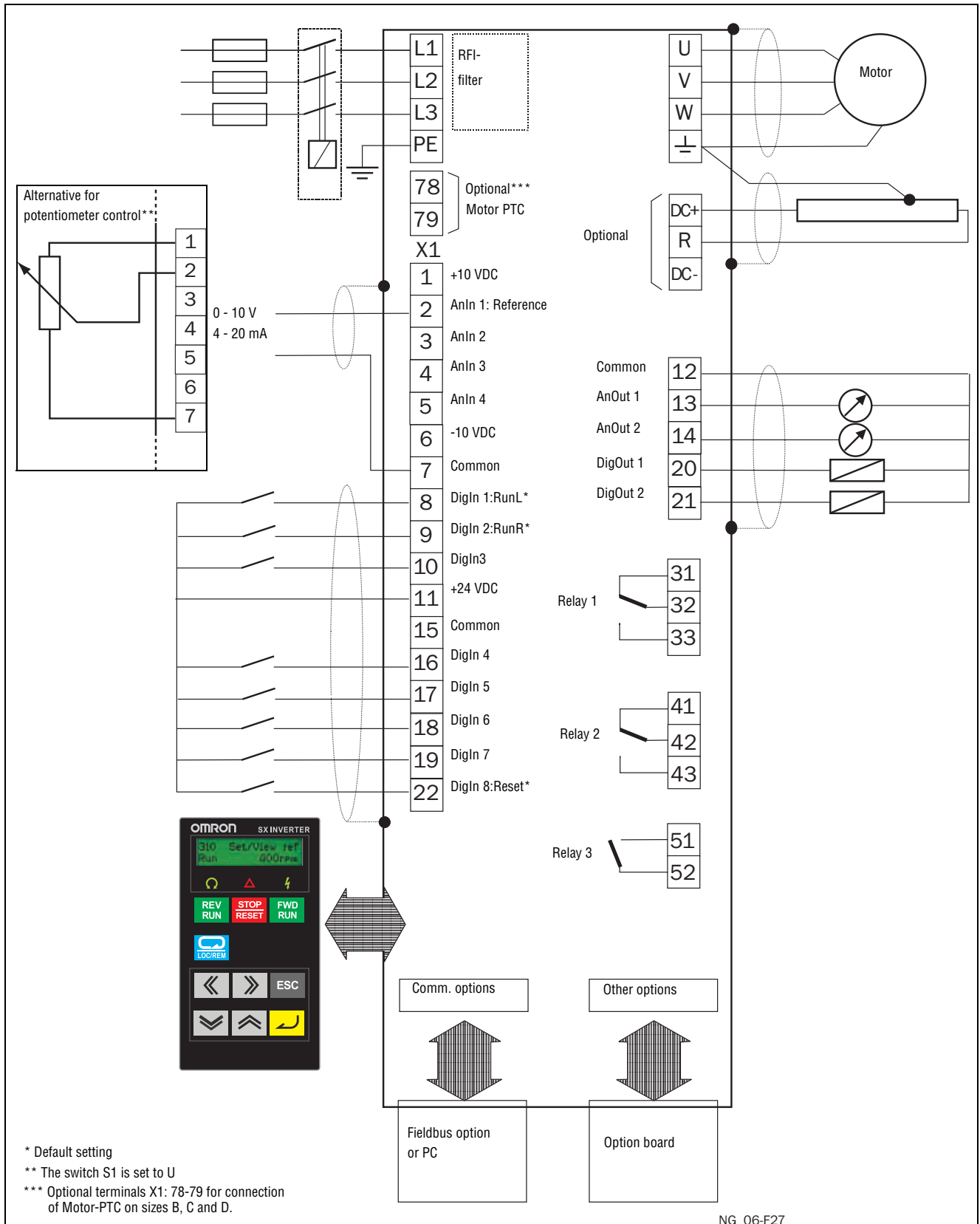

Fig. 36 Connection example

## 5-5 Connecting the Control Signals

### 5-5-1 Cables

The standard control signal connections are suitable for stranded flexible wire up to 1.5 mm<sup>2</sup> and for solid wire up to 2.5 mm<sup>2</sup>.

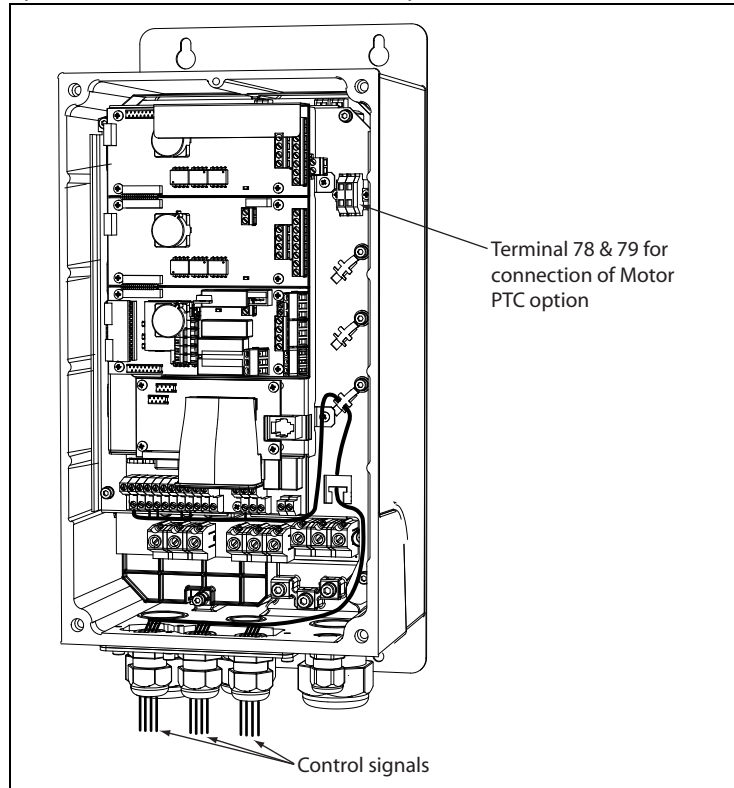

Fig. 37 Connecting the control signals SX-D40P7 to SX-D47P5

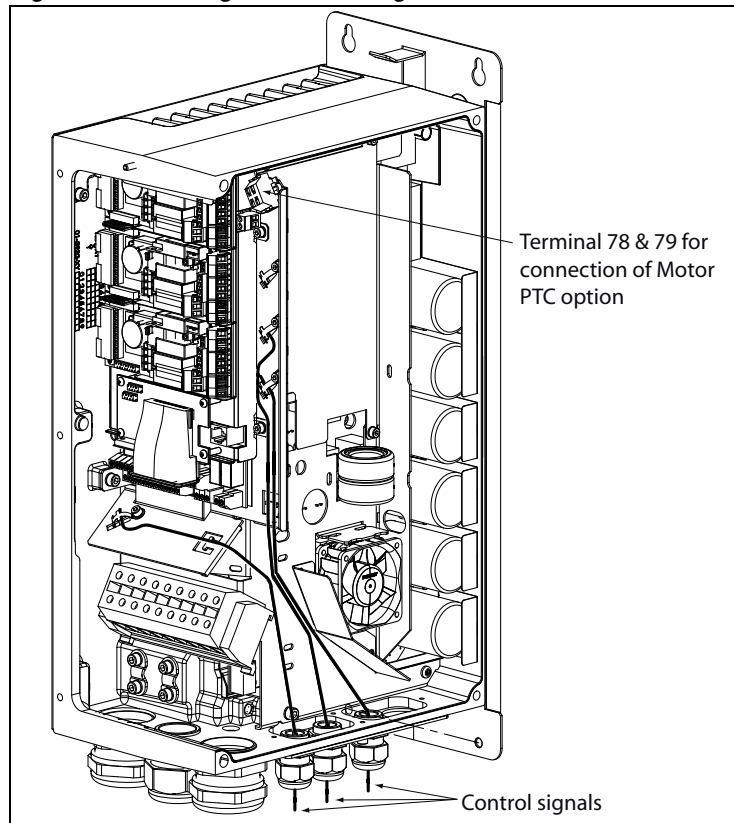

Fig. 38 Connecting the control signals SX-D4011 to SX-D4022

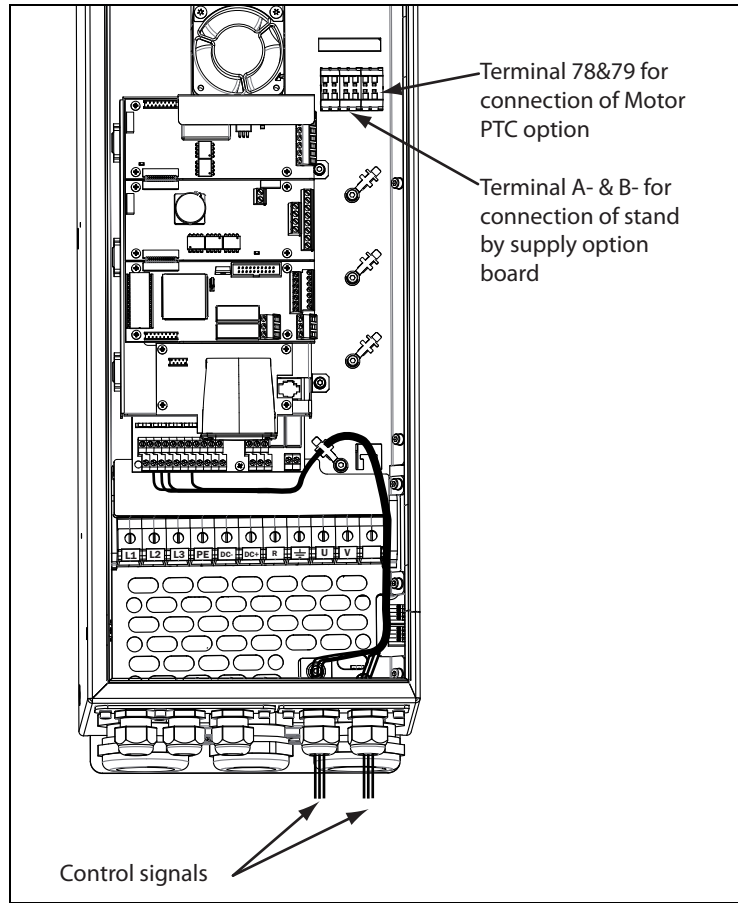

Fig. 39 .Connecting the control signals SX-D4030 to SX-D4037

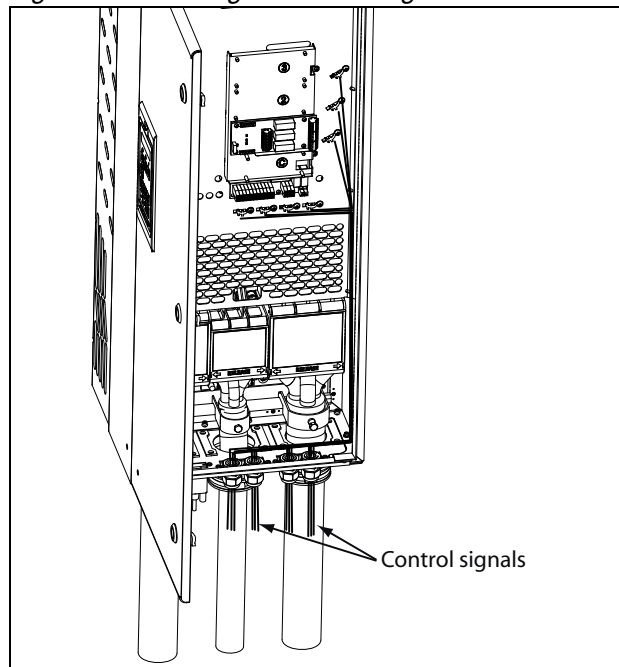

Fig. 40 Connecting the control signals SX-D4045 to SX-D4090

- Note** The screening of control signal cables is necessary to comply with the immunity levels given in the EMC Directive (it reduces the noise level).
- Note** Control cables must be separated from motor and mains cables.

## 5-5-2 Types of control signals

Always make a distinction between the different types of signals. Because the different types of signals can adversely affect each other, use a separate cable for each type. This is often more practical because, for example, the cable from a pressure sensor may be connected directly to the variable speed drive.

We can distinguish between the following types of control signals:

### Analogue inputs

Voltage or current signals, (0-10 V, 0/4-20 mA) normally used as control signals for speed, torque and PID feedback signals.

### Analogue outputs

Voltage or current signals, (0-10 V, 0/4-20 mA) which change slowly or only occasionally in value. In general, these are control or measurement signals.

### Digital

Voltage or current signals (0-10 V, 0-24 V, 0/4-20 mA) which can have only two values (high or low) and only occasionally change in value.

### Data

Usually voltage signals (0-5 V, 0-10 V) which change rapidly and at a high frequency, generally data signals such as RS232, RS485, Profibus, etc.

### Relay

Relay contacts (0-250 VAC) can switch highly inductive loads (auxiliary relay, lamp, valve, brake, etc.).

Signal type	Maximum wire size	Tightening torque	Cable type
Analogue	Rigid cable: 0.14-2.5 mm <sup>2</sup>	0.5 Nm	Screened
Digital	Flexible cable: 0.14-1.5 mm <sup>2</sup>		Screened
Data			Screened
Relay	Cable with ferrule: 0.25-1.5 mm <sup>2</sup>		Not screened

### Example:

The relay output from a variable speed drive which controls an auxiliary relay can, at the moment of switching, form a source of interference (emission) for a measurement signal from, for example, a pressure sensor. Therefore it is advised to separate wiring and screening to reduce disturbances.

### 5-5-3 Screening

For all signal cables the best results are obtained if the screening is connected to both ends: the VSD side and the at the source (e.g. PLC, or computer). See Fig. 41.

It is strongly recommended that the signal cables be allowed to cross mains and motor cables at a 90° angle. Do not let the signal cable go in parallel with the mains and motor cable.

### 5-5-4 Single-ended or double-ended connection?

In principle, the same measures applied to motor cables must be applied to all control signal cables, in accordance with the EMC-Directives.

For all signal cables as mentioned in section 5-5-2 the best results are obtained if the screening is connected to both ends. See Fig. 41.

**Note** Each installation must be examined carefully before applying the proper EMC measurements.

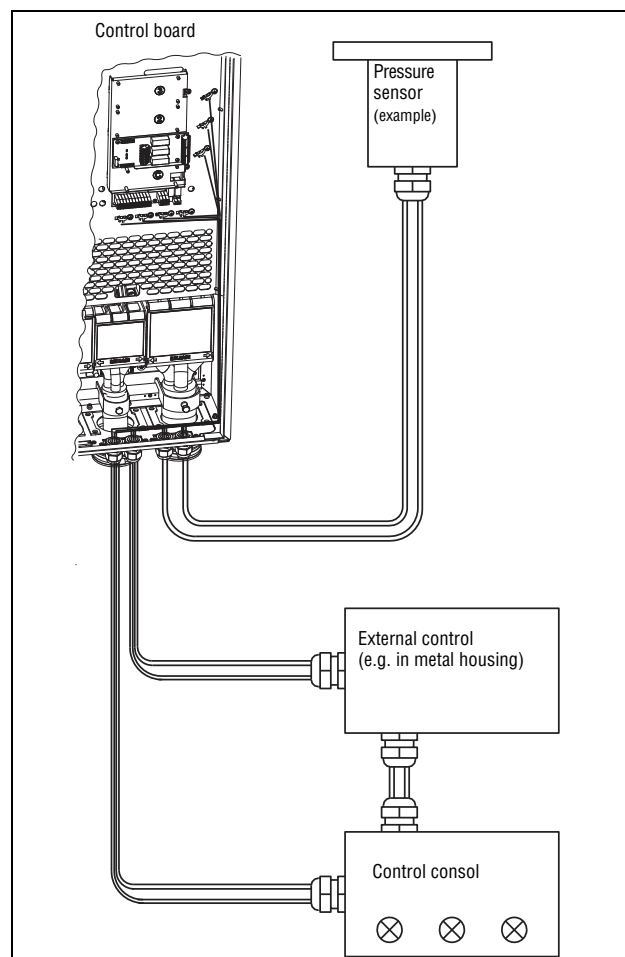

Fig. 41 Electro Magnetic (EM) screening of control signal cables.

### 5-5-5 Current signals ((0)4-20 mA)

A current signal like (0)4-20 mA is less sensitive to disturbances than a 0-10 V signal, because it is connected to an input which has a lower impedance (250  $\Omega$ ) than a voltage signal (20 k $\Omega$ ). It is therefore strongly advised to use current control signals if the cables are longer than a few metres.



### **5-5-6 Twisted cables**

Analogue and digital signals are less sensitive to interference if the cables carrying them are “twisted”. This is certainly to be recommended if screening cannot be used. By twisting the wires the exposed areas are minimised. This means that in the current circuit for any possible High Frequency (HF) interference fields, no voltage can be induced. For a PLC it is therefore important that the return wire remains in proximity to the signal wire. It is important that the pair of wires is fully twisted over 360°.

## **5-6 Connecting options**

The option cards are connected by the optional connectors X4 or X5 on the control board see Fig. 35, page 41 and mounted above the control board. The inputs and outputs of the option cards are connected in the same way as other control signals.



# SECTION 6 Applications

## 6-1 Applications

This chapter contains tables giving an overview of many different applications/duties in which it is suitable to use variable speed drives from OMRON. Further on you will find application examples of the most common applications and solutions.

### 6-1-1 Cranes

Challenge	Omron SX-F solution	Menu
Starting with heavy load is difficult and risky. Can lead to jerks causing swinging load.	Direct torque control, fast motor pre-magnetization and precise brake control gives instant yet soft start with heavy load.	331–338, 339, 351
Jerky movements can cause load to be dropped, jeopardizing safety of people and goods.	Deviation control immediately detects load change. Signals to parallel safety system to activate mechanical brakes.	3AB, 3AC
Crane is driven slowly when returning empty or with light load. Valuable time is lost.	Speed can be increased by field weakening.	343, 3AA, 3AD, 713
Braking with heavy load is difficult and risky. Can lead to jerks causing swinging load.	Direct torque control and vector brake gradually reduce speed to zero before mechanical brake is activated.	213, 33E, 33F, 33G
Operator starts braking long before end position to avoid jerks. Valuable time is lost.	System automatically stops crane at end position. Operator can safely drive at full speed.	3A2–3AA

### 6-1-2 Crushers

Challenge	Omron SX-F solution	Menu
High start currents require larger fuses and cables, or for mobile crushers larger diesel generators.	Direct torque control reduces start current. Same fuses as those for the motor, or smaller generator.	331-338, 351
Difficult to start with heavy load.	Possible to boost torque at start to overcome initial torque peak.	351–353
Material that could cause damage gets into the crusher.	Load Curve Protection quickly detects deviation. Warning is sent or safety stop activated.	411–41C9
Process inefficiency due to e.g. broken feeder or worn jaw. Wasted energy, mechanical stress, and risk of process failure.	Load Curve Protection quickly detects deviation from normal load. Warning is sent or safety stop activated.	411–41B, 41C1–41C9

### 6-1-3 Mills

Challenge	Omron SX-F solution	Menu
High start currents require larger fuses and cables. Cause stress on equipment and higher energy cost.	Direct torque control reduces start current. Same fuses can be used as those required for the motor.	331-338, 350
Difficult to start with heavy load.	Possible to boost torque at start to overcome initial torque peak.	351–353
Material that could cause damage gets into the mill.	Load Curve Protection quickly detects deviation. Warning is sent or safety stop activated.	411–41C9
Process inefficiency due to broken or worn equipment. Energy wasted and risk of process failure.	Load Curve Protection quickly detects deviation. Warning is sent or safety stop activated.	411–41B, 41C1–41C9

**6-1-4 Mixers**

<b>Challenge</b>	<b>Omron SX-F solution</b>	<b>Menu</b>
High start currents require larger fuses and cables. Cause stress on equipment and higher energy cost.	Direct torque control reduces start current. Same fuses can be used as those required for the motor.	331-338, 350
Difficult to determine when mixing process is ready.	Built-in shaft power monitor determines when viscosity is right.	411-41B
Process inefficiency due to e.g. a damaged or broken blade. Energy wasted and risk of process failure.	Load Curve Protection quickly detects deviation. Warning is sent or safety stop activated.	411-41B, 41C1 -41C9

# SECTION 7

## Main Features

This chapter contains descriptions of the main features of the VSD.

### 7-1 Parameter sets

Parameter sets are used if an application requires different settings for different modes. For example, a machine can be used for producing different products and thus requires two or more maximum speeds and acceleration/deceleration times. With the four parameter sets different control options can be configured with respect to quickly changing the behaviour of the VSD. It is possible to adapt the VSD online to altered machine behaviour. This is based on the fact that at any desired moment any one of the four parameter sets can be activated during Run or Stop, via the digital inputs or the control panel and menu [241].

Each parameter set can be selected externally via a digital input. Parameter sets can be changed during operation and stored in the control panel.

**Note** The only data not included in the parameter set is Motor data 1-4, (entered separately), language, communication settings, selected set, local remote, and keyboard locked.

#### Define parameter sets

When using parameter sets you first decide how to select different parameter sets. The parameter sets can be selected via the control panel, via digital inputs or via serial communication. All digital inputs and virtual inputs can be configured to select parameter set. The function of the digital inputs is defined in the menu [520].

Fig. 42 shows the way the parameter sets are activated via any digital input configured to Set Ctrl 1 or Set Ctrl 2.

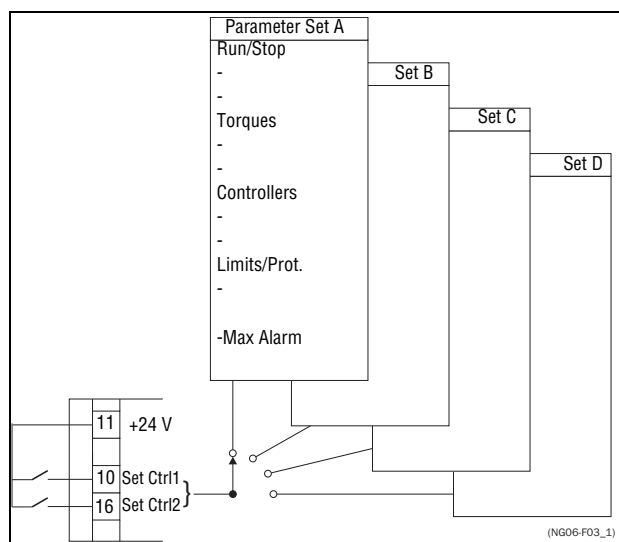

Fig. 42 Selecting the parameter sets

### Select and copy parameter set

The parameter set selection is done in menu [241], Select Set. First select the main set in menu [241], normally A. Adjust all settings for the application. Usually most parameters are common and therefore it saves a lot of work by copying set A>B in menu [242]. When parameter set A is copied to set B you only change the parameters in the set that need to be changed. Repeat for C and D if used.

With menu [242], Copy Set, it is easy to copy the complete contents of a single parameter set to another parameter set. If, for example, the parameter sets are selected via digital inputs, DigIn 3 is set to Set Ctrl 1 in menu [523] and DigIn 4 is set to Set Ctrl 2 in menu [524], they are activated as in Table 18.

Activate the parameter changes via digital input by setting menu [241], Select Set to DigIn.

Table 18 Parameter set

Parameter set	Set Ctrl 1	Set Ctrl 2
A	0	0
B	1	0
C	0	1
D	1	1

**Note** The selection via the digital inputs is immediately activated. The new parameter settings will be activated on-line, also during Run.

**Note** The default parameter set is parameter set A.

### Examples

Different parameter sets can be used to easily change the setup of a VSD to adapt quickly to different application requirements. For example when

- a process needs optimized settings in different stages of the process, to
  - increase the process quality
  - increase control accuracy
  - lower maintenance costs
  - increase operator safety

With these settings a large number of options are available. Some ideas are given here:

### Multi frequency selection

Within a single parameter set the 7 preset references can be selected via the digital inputs. In combination with the parameter sets, 28 preset references can be selected using all 5 digital inputs: DigIn1, 2 and 3 for selecting preset reference within one parameter set and DigIn 4 and DigIn 5 for selecting the parameter sets.

### Bottling machine with 3 different products

Use 3 parameter sets for 3 different Jog reference speeds when the machine needs to be set up. The 4th parameter set can be used for "normal" remote control when the machine is running at full production.

### Product changing on winding machines

If a machine has to change between 2 or 3 different products e.g. winding machine with different gauges of thread, it is important that acceleration, deceleration times, Max Speed and Max Torque are adapted. For each thread size a different parameter set can be used.

### Manual - automatic control

If in an application something is filled up manually and then the level is automatically controlled using PID regulation, this is solved using one parameter set for the manual control and one for the automatic control.

#### 7-1-1 One motor and one parameter set

This is the most common application for pumps and fans.

Once default motor M1 and parameter set A have been selected:

1. Enter the settings for motor data.
2. Enter the settings for other parameters e.g. inputs and outputs

#### 7-1-2 One motor and two parameter sets

This application is useful if you for example have a machine running at two different speeds for different products.

Once default motor M1 is selected:

1. Select parameter set A in menu [241].
2. Enter motor data in menu [220].
3. Enter the settings for other parameters e.g. inputs and outputs.
4. If there are only minor differences between the settings in the parameter sets, you can copy parameter set A to parameter set B, menu [242].
5. Enter the settings for parameters e.g. inputs and outputs.

**Note** Do not change motor data in parameter set B.

#### 7-1-3 Two motors and two parameter sets

This is useful if you have a machine with two motors that can not run at the same time, such as a cable winding machine that lifts up the reel with one motor and then turns the wheel with the other motor.

One motor must stop before changing to an other motor.

1. Select parameter set A in menu [241].
2. Select motor M1 in menu [212].
3. Enter motor data and settings for other parameters e.g. inputs and outputs.
4. Select parameter set B in menu [241].
5. Select M2 in menu [212].
6. Enter motor data and settings for other parameters e.g. inputs and outputs.

#### 7-1-4 Autoreset at trip

For several non-critical application-related failure conditions, it is possible to automatically generate a reset command to overcome the fault condition. The selection can be made in menu [250]. In this menu the maximum number of automatically generated restarts allowed can be set, see menu [251], after this the VSD will stay in fault condition because external assistance is required.

##### Example

The motor is protected by an internal protection for thermal overload. When this protection is activated, the VSD should wait until the motor is cooled down enough before resuming normal operation. When this problem occurs three times in a short period of time, external assistance is required.

The following settings should be applied:

- Insert maximum number of restarts; set menu [251] to 3.
- Activate Motor I<sup>2</sup>t to be automatically reset; set menu [25A] to 300 s.

- Set relay 1, menu [551] to AutoRst Trip; a signal will be available when the maximum number of restarts is reached and the VSD stays in fault condition.
- The reset input must be constantly activated.

### 7-1-5 Reference priority

The active speed reference signal can be programmed from several sources and functions. The table below shows the priority of the different functions with regards to the speed reference.

Table 19 Reference priority

Jog Mode	Preset Reference	Motor Pot	Ref. Signal
On/Off	On/Off	On/Off	Option cards
On	On/Off	On/Off	Jog Ref
Off	On	On/Off	Preset Ref
Off	Off	On	Motor pot commands

### 7-1-6 Preset references

The VSD is able to select fixed speeds via the control of digital inputs. This can be used for situations where the required motor speed needs to be adapted to fixed values, according to certain process conditions. Up to 7 preset references can be set for each parameter set, which can be selected via all digital inputs that are set to Preset Ctrl1, Preset Ctrl2 or Preset Ctrl3. The amount digital inputs used that are set to Preset Ctrl determines the number of Preset References available; using 1 input gives 1 speed, using 2 inputs gives 3 speeds and using 3 inputs gives 7 speeds.

#### Example

The use of four fixed speeds, at 50 / 100 / 300 / 800 rpm, requires the following settings:

- Set DigIn 5 as first selection input; set [525] to Preset Ctrl1.
- Set DigIn 6 as second selection input; set [526] to Preset Ctrl2.
- Set menu [341], Min Speed to 50 rpm.
- Set menu [362], Preset Ref 1 to 100 rpm.
- Set menu [363], Preset Ref 2 to 300 rpm.
- Set menu [364], Preset Ref 3 to 800 rpm.

With these settings, the VSD switched on and a RUN command given, the speed will be:

- 50 rpm, when both DigIn 5 and DigIn 6 are low.
- 100 rpm, when DigIn 5 is high and DigIn 6 is low.
- 300 rpm, when DigIn 5 is low and DigIn 6 is high.
- 800 rpm, when both DigIn 5 and DigIn 6 are high.



## 7-2 Remote control functions

Operation of the Run/Stop/Enable/Reset functions

As default, all the run/stop/reset related commands are programmed for remote operation via the inputs on the terminal strip (terminals 1-22) on the control board. With the function Run/Stp Ctrl [215] and Reset Control [216], this can be selected for keyboard or serial communication control.

**Note** The examples in this paragraph do not cover all possibilities. Only the most relevant combinations are given. The starting point is always the default setting (factory) of the VSD.

### Default settings of the Run/Stop/Enable/Reset functions

The default settings are shown in Fig. 43. In this example the VSD is started and stopped with DigIn 2 and a reset after trip can be given with DigIn 8.

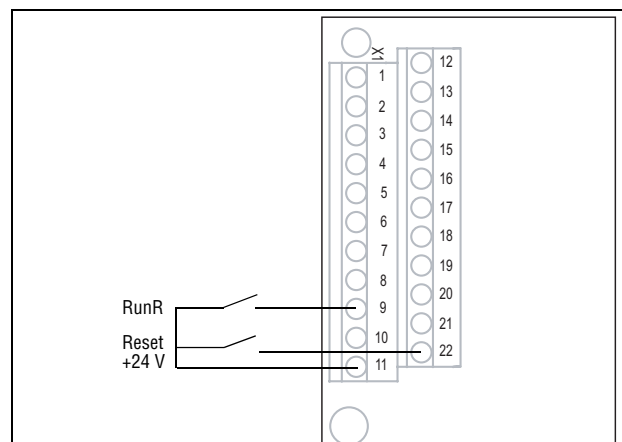

Fig. 43 Default setting Run/Reset commands

The inputs are default set for level-control. The rotation is determined by the setting of the digital inputs.

### Enable and Stop functions

Both functions can be used separately or simultaneously. The choice of which function is to be used depends on the application and the control mode of the inputs (Level/Edge [21A]).

**Note** In Edge mode, at least one digital input must be programmed to “stop”, because the Run commands are only able to start the VSD.

#### Enable

Input must be active (HI) to allow any Run signal. If the input is made LOW, the output of the VSD is immediately disabled and the motor will coast.

**Caution** If the Enable function is not programmed to a digital input, it is considered to be active internally.

#### Stop

If the input is low then the VSD will stop according to the selected stop mode set in menu [33B] Stop Mode. Fig. 44 shows the function of the Enable and the Stop input and the Stop Mode=Decel [33B].

To run the input must be high.

**Note** Stop Mode=Coast [33B] will give the same behaviour as the Enable input.

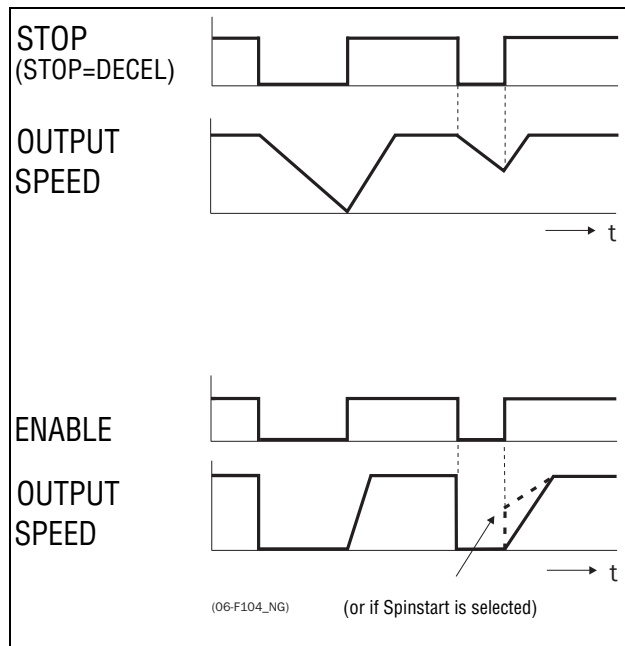

Fig. 44 Functionality of the Stop and Enable input

### Reset and Autoreset operation

If the VSD is in Stop Mode due to a trip condition, the VSD can be remotely reset by a pulse (“low” to “high” transition) on the Reset input, default on DigIn 8. Depending on the selected control method, a restart takes place as follows:

#### Level-control

If the Run inputs remain in their position the VSD will start immediately after the Reset command is given.

#### Edge-control

After the Reset command is given a new Run command must be applied to start the VSD again.

Autoreset is enabled if the Reset input is continuously active. The Autoreset functions are programmed in menu Autoreset [250].

**Note** If the control commands are programmed for Keyboard control or Com, Autoreset is not possible.

#### Run Inputs Level-controlled.

The inputs are set as default for level-control. This means that an input is activated by making the input continuously “High”. This method is commonly used if, for example, PLCs are used to operate the VSD.

**Caution** Level-controlled inputs DO NOT comply with the Machine Directive, if the inputs are directly used to start and stop the machine.

The examples given in this and the following paragraphs follow the input selection shown in Fig. 45.

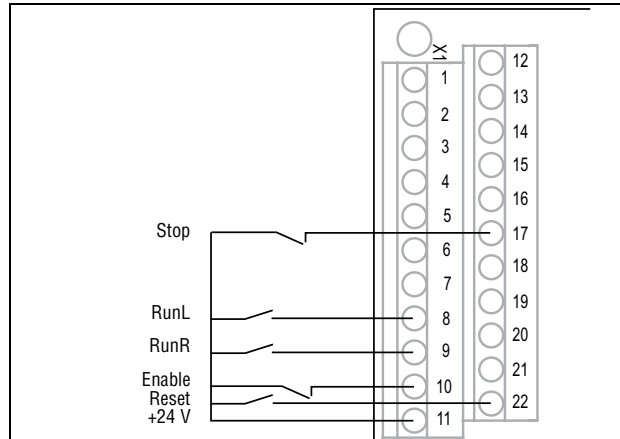

Fig. 45 Example of wiring for Run/Stop/Enable/Reset inputs

The Enable input must be continuously active in order to accept any run-right or run-left command. If both RunR and RunL inputs are active, then the VSD stops according to the selected Stop Mode. Fig. 46 gives an example of a possible sequence.

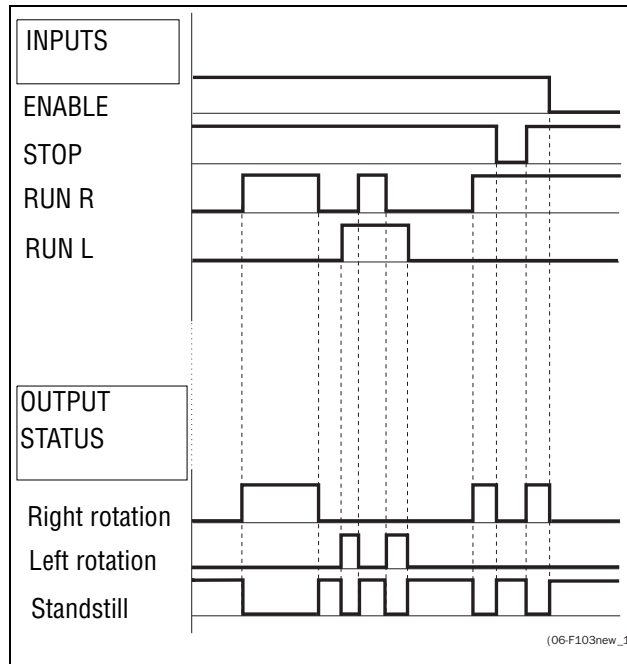

Fig. 46 Input and output status for level-control

### Run Inputs Edge-controlled

Menu [21A] Start signal Level/Edge must be set to Edge to activate edge control. This means that an input is activated by a “low” to “high” transition or vice versa.

**Note** Edge-controlled inputs comply with the Machine Directive (see chapter EMC), if the inputs are directly used for starting and stopping the machine.

See Fig. 45. The Enable and Stop input must be active continuously in order to accept any run-right or run-left command. The last edge (RunR or RunL) is valid. Fig. 47 gives an example of a possible sequence.

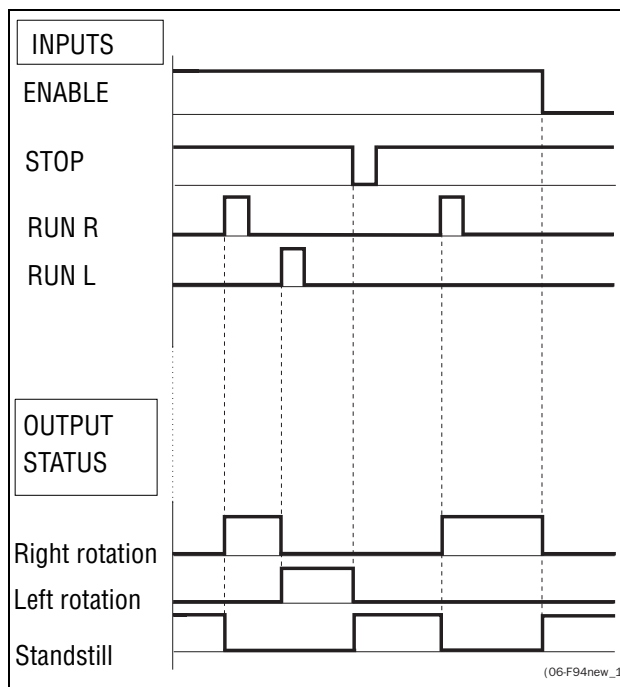

Fig. 47 Input and output status for edge-control

### 7-3 Performing an Identification Run

To get the optimum performance out of your VSD/motor combination, the VSD must measure the electrical parameters (resistance of stator winding, etc.) of the connected motor. See menu [229], Motor ID-Run.

It is recommended that the extended ID run be used before the motor is installed in the application.

If this is not possible, the short ID run should be used.

**Warning** During the extended ID RUN, the motor shaft will rotate. Take safety measures to avoid unforeseen dangerous situations.

## 7-4 Using the Control Panel Memory

Data can be copied from the VSD to the memory in the control panel and vice versa. To copy all data (including parameter set A-D and motor data) from the VSD to the control panel, select Copy to CP[244], Copy to CP.

To copy data from the control panel to the VSD, enter the menu [245], Load from CP and select what you want to copy.

The memory in the control panel is useful in applications with VSDs without a control panel and in applications where several variable speed drives have the same setup. It can also be used for temporary storage of settings. Use a control panel to upload the settings from one VSD and then move the control panel to another VSD and download the settings.

**Note** Load from and copy to the VSD is only possible when the VSD is in stop mode.

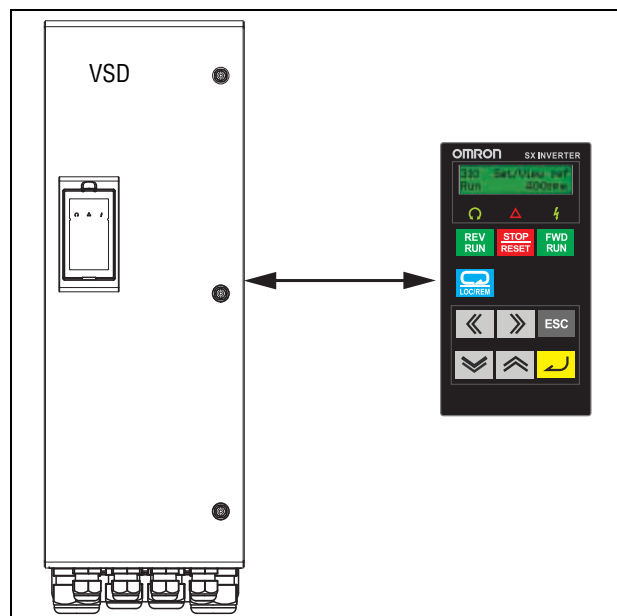

Fig. 48 Copy and load parameters between VSD and control panel

## **7-5 Load Monitor and Process Protection [400]**

### **7-5-1 Load Monitor [410]**

The monitor functions enable the VSD to be used as a load monitor. Load monitors are used to protect machines and processes against mechanical overload and underload, such as a conveyer belt or screw conveyer jamming, belt failure on a fan or a pump dry running. The load is measured in the VSD by the calculated motor shaft torque. There is an overload alarm (Max Alarm and Max Pre-Alarm) and an underload alarm (Min Alarm and Min Pre-Alarm).

The Basic Monitor type uses fixed levels for overload and underload (pre-) alarms over the whole speed range. This function can be used in constant load applications where the torque is not dependent on the speed, e.g. conveyer belt, displacement pump, screw pump, etc.

For applications with a torque that is dependent on the speed, the Load Curve monitor type is preferred. By measuring the actual load curve of the process, characteristically over the range of minimum speed to maximum speed, an accurate protection at any speed can be established.

The max and min alarm can be set for a trip condition. The pre-alarms act as a warning condition. All the alarms can be monitored on the digital or relay outputs.

The autosest function automatically sets the 4 alarm levels whilst running: maximum alarm, maximum pre-alarm, minimum alarm and minimum pre-alarm.

Fig. 49 gives an example of the monitor functions for constant torque applications.

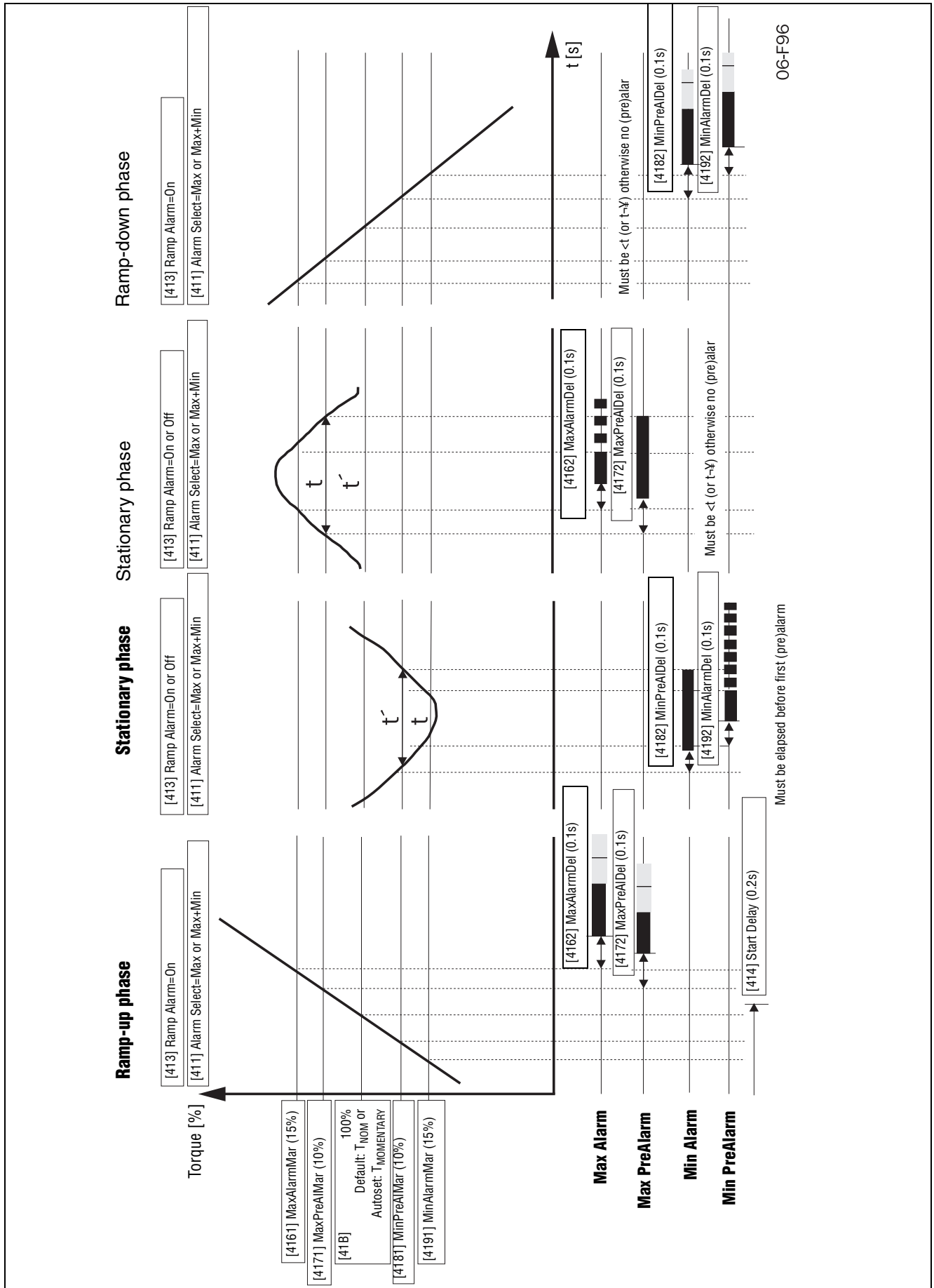

Fig. 49





## SECTION 8

### EMC

Specific instructions related to EMC and Machine Directive can be found throughout this instruction manual.

#### 8-1 EMC standards

The variable speed drive complies with the following standards:

EN(IEC)61800-3:2004 Adjustable speed electronic power drive systems, part 3, EMC product standards:

Standard: category C3, for systems of rated supply voltage < 1000 VAC, intended for use in the second environment.

Optional: Category C2, for systems of rated supply voltage < 1000 V, which is neither a plug in device nor a movable device and, when used in the first environment, is intended to be installed and commissioned only by experienced person with the necessary skills in installing and/or commissioning variable speed drives including their EMC aspects.



# SECTION 9

## Operation via the Control Panel

This chapter describes how to use the control panel. The VSD can be delivered with a control panel or a blank panel.

### 9-1 General

The control panel displays the status of the VSD and is used to set all the parameters. It is also possible to control the motor directly from the control panel. The control panel can be built-in or located externally via serial communication. The VSD can be ordered without the control panel. Instead of the control panel there will be a blank panel.

**Note** The VSD can run without the control panel being connected. However the settings must be such that all control signals are set for external use.

### 9-2 The control panel

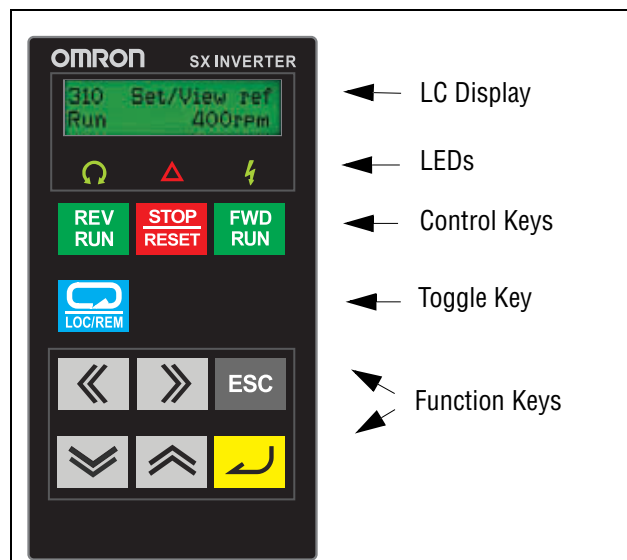

Fig. 50 Control panel

#### 9-2-1 The display

The display is back lit and consists of 2 rows, each with space for 16 characters. The display is divided into six areas.

The different areas in the display are described below:

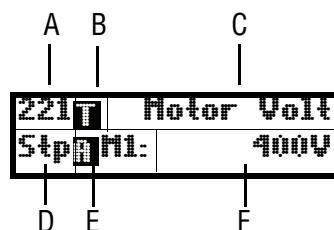

Fig. 51 The display

- Area A: Shows the actual menu number (3 or 4 digits).
- Area B Shows if the menu is in the toggle loop or the VSD is set for Local operation.
- Area C: Shows the heading of the active menu.
- Area D: Shows the status of the VSD (3 digits).  
The following status indications are possible:  
Acc: Acceleration  
Dec: Deceleration  
I<sup>2</sup>t : Active I<sup>2</sup>t protection  
Run: Motor runs  
Trp: Tripped  
Stp: Motor is stopped  
VL: Operating at Voltage limit  
slp: Sleep mode  
SL: Operating at Speed limit  
CL: Operating at Current limit  
TL: Operating at Torque limit  
OT: Operating at Temperature Limit  
LV: Operating at Low Voltage  
Sby: Operating from Standby power supply  
SST: Operating Safe Stop, is blinking when activated  
LCL: Operating with low cooling liquid level
- Area E: Shows active parameter set and if it is a motor parameter.
- Area F: Shows the setting or selection in the active menu.  
This area is empty at the 1st level and 2nd level menu. This area also shows warnings and alarm messages.

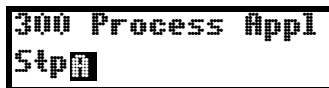

Fig. 52 Example 1st level menu



Fig. 53 Example 2nd level menu

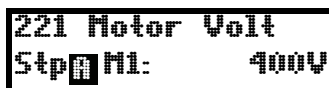

Fig. 54 Example 3d level menu

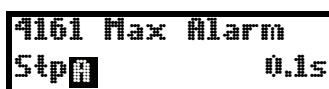

Fig. 55 Example 4th level menu

### 9-2-2 Indications on the display

The display can indicate +++ or - - - if a parameter is out of range. In the VSD there are parameters which are dependent on other parameters. For example, if the speed reference is 500 and the maximum speed value is set to a value below 500, this will be indicated with +++ on the display. If the minimum speed value is set over 500, - - - is displayed.

### 9-2-3 LED indicators

The symbols on the control panel have the following functions:

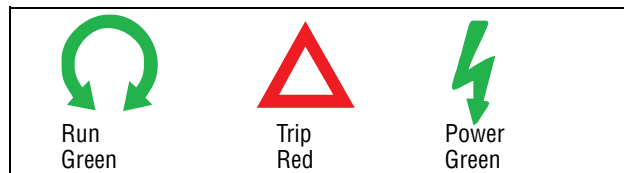

Fig. 56 LED indications

Table 20 LED indication

Symbol	Function		
	ON	BLINKING	OFF
POWER (green)	Power on	-----	Power off
TRIP (red)	VSD tripped	Warning/Limit	No trip
RUN (green)	Motor shaft rotates	Motor speed increase/decrease	Motor stopped

**Note** If the control panel is built in, the back light of the display has the same function as the Power LED in Table 20 (Blank panel LEDs).

### 9-2-4 Control keys

The control keys are used to give the Run, Stop or Reset commands directly. As default these keys are disabled, set for remote control. Activate the control keys by selecting Keyboard in the menus Ref Control [214], Run/Stop Control [215] and Reset Ctrl [216].

If the Enable function is programmed on one of the digital inputs, this input must be active to allow Run/Stop commands from the control panel.

Table 21 Control keys

<b>REV RUN</b>	RUN L:	Gives a start with left rotation
<b>STOP RESET</b>	STOP/RESET:	Stops the motor or resets the VSD after a trip
<b>FWD RUN</b>	RUN R:	Gives a start with right rotation

**Note** It is not possible to simultaneously activate the Run/Stop commands from the keyboard and remotely from the terminal strip (terminals 1-22).

## 9-2-5 The Toggle and Loc/Rem Key



This key has two functions: Toggle and switching between Loc/Rem function.

Press one second to use the toggle function.

Press and hold the toggle key for more than five seconds to switch between Local and Remote function, depending on the settings in [2171] and [2172].

When editing values, the toggle key can be used to change the sign of the value, see section 9-5, page 75.

### Toggle function

Using the toggle function makes it possible to easily step through selected menus in a loop. The toggle loop can contain a maximum of ten menus. As default the toggle loop contains the menus needed for Quick Setup. You can use the toggle loop to create a quick-menu for the parameters that are most importance to your specific application.

**Note** Do not keep the Toggle key pressed for more than five seconds without pressing either the +, - or Esc key, as this may activate the Loc/Rem function of this key instead. See menu [217].

### Add a menu to the toggle loop

1. Go to the menu you want to add to the loop.
2. Press the Toggle key and keep it pressed while pressing the + key.

### Delete a menu from the toggle loop

1. Go to the menu you want to delete using the toggle key.
2. Press the Toggle key and keep it pressed while pressing the - key.

### Delete all menus from the toggle loop

1. Press the Toggle key and keep it pressed while pressing the Esc key.
2. Confirm with Enter.

### Default toggle loop

Fig. 57 shows the default toggle loop. This loop contains the necessary menus that need to be set before starting. Press Toggle to enter menu [211] then use the Next key to enter the sub menus [212] to [21A] and enter the parameters. When you press the Toggle key again, menu [221] is displayed.

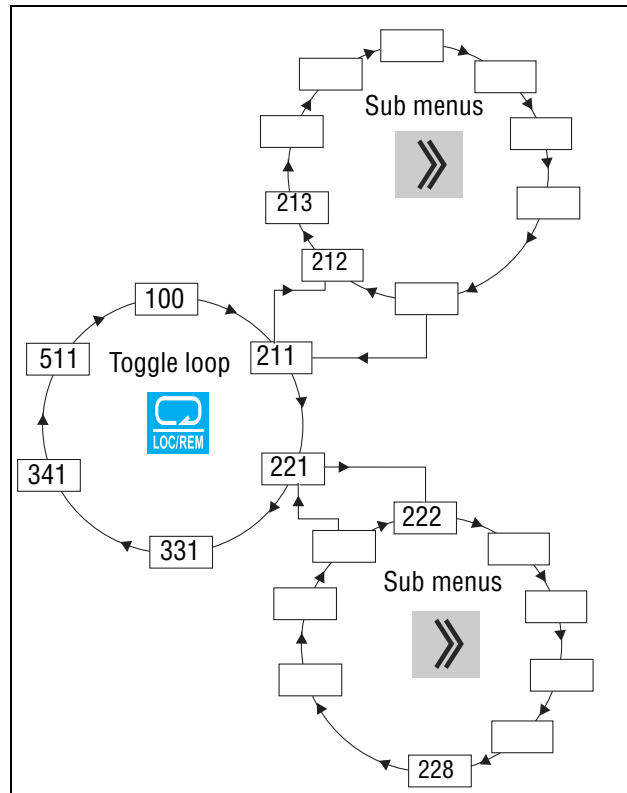



Fig. 57 Default toggle loop

### Indication of menus in toggle loop

Menus included in the toggle loop are indicated with a  in area B in the display.

### Loc/Rem function

The Loc/Rem function of this key is disabled as default. Enable the function in menu [2171] and/or [2172].

With the function Loc/Rem you can change between local and remote control of the VSD from the control panel. The function Loc/Rem can also be changed via the DigIn, see menu Digital inputs [520]

### Change control mode

1. Press the Loc/Rem key for five seconds, until Local? or Remote? is displayed.
2. Confirm with Enter.
3. Cancel with Esc.

### Local mode

Local mode is used for temporary operation. When switched to LOCAL operation, the VSD is controlled via the defined Local operation mode, i.e. [2171] and [2172]. The actual status of the VSD will not change, e.g. Run/Stop conditions and the actual speed will remain exactly the same. When the VSD is set to Local operation, the display will show  in area B in the display.

### Remote mode

When the VSD is switched to REMOTE operation, the VSD will be controlled according to selected control methods in the menu's Reference Control [214], Run/Stop Control [215] and Reset Control [216].

To monitor the actual Local or Remote status of the VSD control, a "Loc/Rem" function is available on the Digital Outputs or Relays. When the VSD is set to Local, the signal on the DigOut or Relay will be active high, in Remote the signal will be inactive low. See menu Digital Outputs [540] and Relays [550].

## 9-2-6 Function keys

The function keys operate the menus and are also used for programming and read-outs of all the menu settings.

Table 22 Function keys







	ENTER key:	-Step to a lower menu level -Confirm a changed setting
	ESCAPE key:	-Step to a higher menu level -Ignore a changed setting, without confirming
	PREVIOUS key:	-Step to a previous menu within the same level -Go to more significant digit in edit mode
	NEXT key:	-Step to a next menu within the same level -Go to less significant digit in edit mode
	- key:	-Decrease a value -Change a selection
	+ key:	-Increase a value -Change a selection

Fig. 58 Menu structure



### 9-3 The menu structure

The menu structure consists of 4 levels:

Main Menu 1st level	The first character in the menu number.
2nd level	The second character in the menu number.
3rd level	The third character in the menu number.
4th level	The fourth character in the menu number.

This structure is consequently independent of the number of menus per level. For instance, a menu can have one selectable menu (Set/View Reference Value [310]), or it can have 17 selectable menus (menu Speeds [340]).

**Note** If there are more than 10 menus within one level, the numbering continues in alphabetic order.

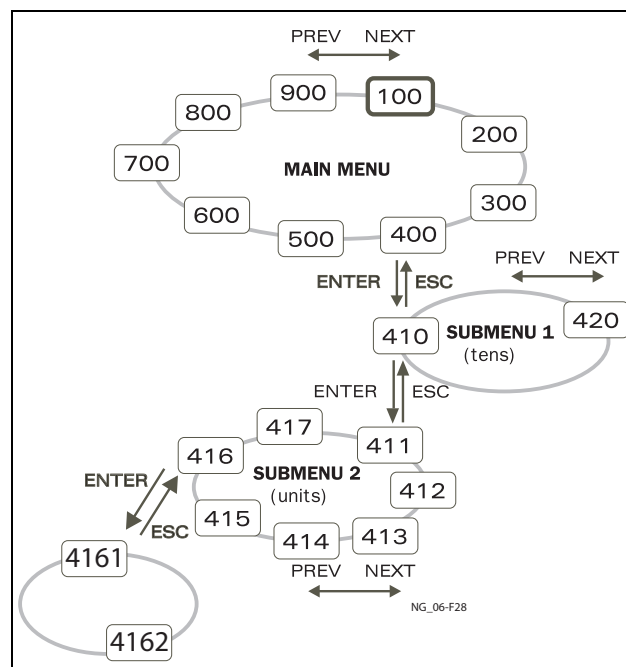

Fig. 59 Menu structure

### 9-3-1 The main menu

This section gives you a short description of the functions in the Main Menu.

#### 100 Preferred View

Displayed at power-up. It displays the actual process value as default. Programmable for many other read-outs.

#### 200 Main Setup

Main settings to get the VSD operable. The motor data settings are the most important. Also option utility and settings.

#### 300 Process and Application Parameters

Settings more relevant to the application such as Reference Speed, torque limitations, PID control settings, etc.

#### 400 Shaft Power Monitor and Process Protection

The monitor function enables the VSD to be used as a load monitor to protect machines and processes against mechanical overload and underload.

#### 500 Inputs/Outputs and Virtual Connections

All settings for inputs and outputs are entered here.

#### 600 Logical Functions and Timers

All settings for conditional signal are entered here.

#### 700 View Operation and Status

Viewing all the operational data like frequency, load, power, current, etc.

#### 800 View Trip Log

Viewing the last 10 trips in the trip memory.

#### 900 Service Information and VSD Data

Electronic type label for viewing the software version and VSD type.

## 9-4 Programming during operation

Most of the parameters can be changed during operation without stopping the VSD. Parameters that can not be changed are marked with a lock symbol in the display.

**Note** If you try to change a function during operation that only can be changed when the motor is stopped, the message "Stop First" is displayed.

## 9-5 Editing values in a menu

Most values in the second row in a menu can be changed in two different ways. Enumerated values like the baud rate can only be changed with alternative 1.



### Alternative 1

When you press the + or - keys to change a value, the cursor is blinking to the left in the display and the value is increased or decreased when you press the appropriate key. If you keep the + or - keys pressed, the value will increase or decrease continuously. When you keep the key pressed the change speed will increase. The Toggle key is used to change the sign of the entered value. The sign of the value will also change when zero is passed. Press Enter to confirm the value.



↑ Blinking

### Alternative 2

Press the + or - key to enter edit mode. Then press the Prev or Next key to move the cursor to the right most position of the value that should be changed. The cursor will make the selected character blink. Move the cursor using the Prev or Next keys. When you press the + or - keys, the character at the cursor position will increase or decrease. This alternative is suitable when you want to make large changes, i.e. from 2 s to 400 s.

To change the sign of the value, press the toggle key. This makes it possible to enter negative values (only valid for certain parameters).

Example: When you press Next the 4 will blink.

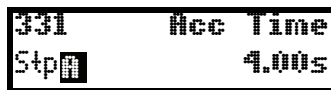

Blinking → ↑

Press Enter to save the setting and Esc to leave the edit mode.

## 9-6 Copy current parameter to all sets

When a parameter is displayed, press the Enter key for 5 seconds. Now the text To all sets? is displayed. Press Enter to copy the setting for current parameter to all sets.

## 9-7 Programming example

This example shows how to program a change of the Acc. Time set from 2.0 s to 4.0 s.

The blinking cursor indicates that a change has taken place but is not saved yet. If at this moment, the power fails, the change will not be saved.

Use the ESC, Prev, Next or the Toggle keys to proceed and to go to other menus.

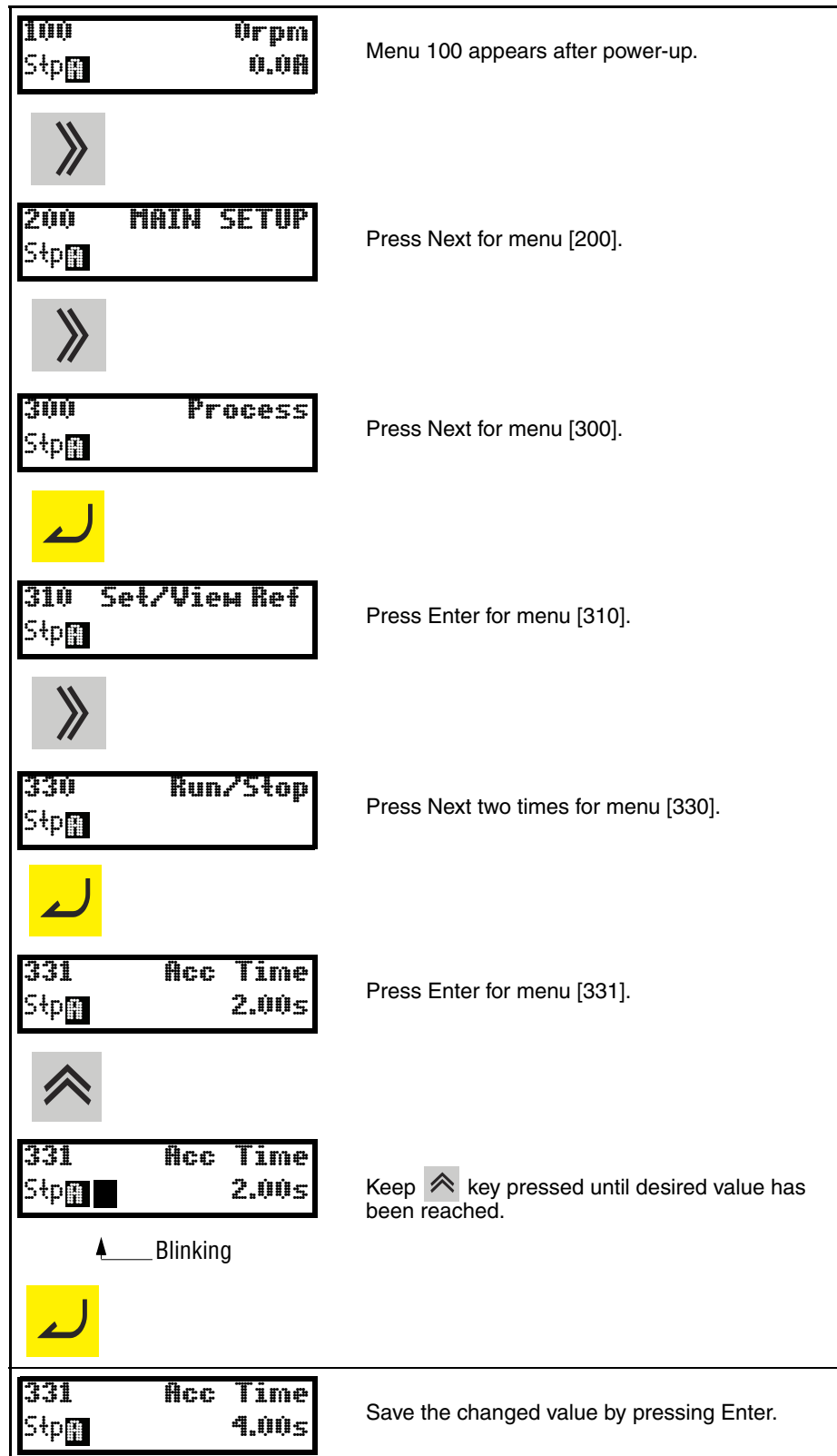

Fig. 60 Programming example

# SECTION 10

## Serial communication

The VSD provides possibility for different types of serial communication:

- Modbus RTU via RS232/485
- Fieldbuses as Profibus DP and DeviceNet
- Industrial Ethernet type Modbus/TCP and EtherCAT

### 10-1 Modbus RTU

The VSD has an asynchronous serial communication interface behind the control panel. The protocol used for data exchange is based in the Modbus RTU protocol, originally developed by Modicon. the physical connection is RS232. The VSD acts as a slave with address 1 in a master-slave configuration. The communication is half-duplex. It has a standard no return zero (NRZ) format.

The baud rate is fixed to 9600.

The character frame format (always 11 bits) has:

- One start bit
- Eight data bits
- Two stop bits
- No parity

It is possible to temporarily connect a personal computer with for example the software EmoSoftCom (programming and monitoring software) to the RS232 connector on the control panel. This can be useful when copying parameters between variable speed drives etc. For permanent connection of a personal computer you have to use one of the communication option boards.

**Note** This RS232 port is not isolated.

**Note** Correct and safe use of a RS232 connection depends on the ground pins of both ports being the same potential. Problems can occur when connecting two ports of e.g. machinery and computers where both ground pins are not the same potential. This may cause hazardous ground loops that can destroy the RS232 ports.

**Note** The control panel RS232 connection is not galvanic isolated.

**Note** The optional RS232/485 card is galvanic isolated.

**Note** Note that the control panel RS232 connection can safely be used in combination with commercial available isolated USB to RS232 converters.

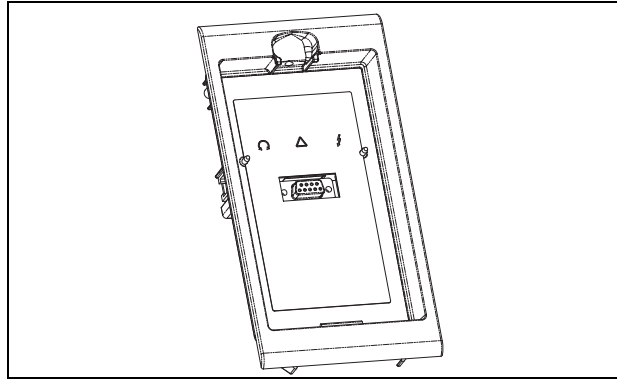

Fig. 61 Mounting frame for the control panel

## 10-2 Parameter sets

Communication information for the different parameter sets.

The different parameter sets in the VSD have the following DeviceNet instance numbers, Profibus slot/index numbers and EtherCAT index numbers:

Parameter set	Modbus/DeviceNet Instance number	Profibus Slot/Index	EtherCAT index (hex)
A	43001–43556	168/160 to 170/205	4bb9-4de4
B	44001–44529	172/140 to 174/185	4fa1-51cc
C	45001–45529	176/120 to 178/165	5389-55b4
D	46001–46529	180/100 to 182/145	5771-599c

Parameter set A contains parameters 43001 to 43556. The parameter sets B, C and D contains the same type of information. For example parameter 43123 in parameter set A contain the same type of information as 44123 in parameter set B.

A DeviceNet instance number can easily be converted into a Profibus slot/index number or an EtherCAT index number according to description in section section 11-8-2, page 254.

## 10-3 Motor data

Communication information for the different motors.

Motor	Modbus/DeviceNet Instance number	Profibus Slot/Index	EtherCAT index (hex)
M1	43041–43048	168/200 to 168/207	4be1-4be8
M2	44041–44048	172/180 to 174/187	4fc9-4fd0
M3	45041–45048	176/160 to 176/167	53b1-53b8
M4	46041–46048	180/140 to 180/147	5799-57a0

M1 contains parameters 43041 to 43048. The M2, M3, and M4 contains the same type of information. For example parameter 43043 in motor M1 contain the same type of information as 44043 in M2.

A DeviceNet instance number can easily be converted into a Profibus slot/index number or an EtherCAT index number according to description in section section 11-8-2, page 254.

## 10-4 Start and stop commands

Set start and stop commands via serial communication..

Modbus/DeviceNet Instance number	Function
42901	Reset
42902	Run, active together with either RunR or RunL to perform start.
42903	RunR
42904	RunL

**Note** Bipolar mode is activated if both RunR and RunL is active.

## 10-5 Reference signal

When menu Reference Control [214] is set to "Com" the following parameter data should be used:

Default	0
Range	-16384 to 16384
Corresponding to	-100% to 100% ref

Communication information

Modbus /DeviceNet Instance number	42905
Profibus slot /Index	168/64
EtherCAT index (hex)	4b59
Fieldbus format	Int
Modbus format	Int

### 10-5-1 Process value

It is also possible to send the Process value feedback signal over a bus (e.g. from a process or temperature sensor) for use with PID Process controller [380].

Set menu Process Source [321] to F(Bus). Use following parameter data for the process value:

Default	0
Range	-16384 o 16384
Corresponding to	-100% to 100% ref

Communication information

Modbus /DeviceNet Instance number	42906
Profibus slot /Index	168/65
EtherCAT index (hex)	4b5a
Fieldbus format	Int
Modbus format	Int

Example:

(See Fielbus option manual for detailed information)

We would like to control the inverter over a bus system using the first two bytes of the Basic Control Message by setting menu [2661] FB Signal 1 to 49972. Further, we also want to transmit a 16 bit signed reference and process value. This is done by setting menu [2662] FB Signal 2 to 42905 and menu [2663] FB Signal 3 to 42906.

**Note** It is possible to view the transmitted process value in control panel menu Operation [710]. The presented value is depending on settings in menus Process Min [324] and Process Max [325].

The reference value is set in modbus number 42905 (0-4000h) corresponds to 0-100% of actual reference value.

10-6 Description of the EInt formats

Modbus parameters can have different formats e.g. a standard unsigned/signed integer, or EInt. EInt, which is described below. All parameters written to a register may be rounded to the number of significant digits used in the internal system.

If a parameter is in EInt format, the 16 bit number should be interpreted like this:

F EEEE MMMMMMMMMMMM

F	Format bit: 0=Unsigned integer mode, 1=EInt mode
EEEE	2 complement signed exponent
MMMMMMMMMMMMM	2 complement signed mantissa.

If the format bit is 0, then can a positive number 0-32767 be represented by bit 0-14.

If the format bit is 1, then is the number interpreted as this:

Value = M \* 10^E

**Note** Parameters with EInt format may return values in both formats (F=0 or F=1).

Example

If you write the value 1004 to a register and this register has 3 significant digits, it will be stored as 1000.

In the floating point format (F=1), one 16-bit word is used to represent large (or very small numbers) with 3 significant digits.

If data is read or written as a fixed point (i.e. no decimals) number between 0-32767, the 15-bit fixed point format (F=0) may be used.

F=Format. 1=floating point format, 0=15 bit as 15-bit fixed point format.

The matrix below describes the contents of the 16-bit word for the two different EInt formats:

B15	B14	B13	B12	B11	B10	B9	B8	B7	B6	B5	B4	B3	B2	B1	B0
F=1	e3	e2	e1	e0	m10	m9	m8	m7	m6	m5	m4	m3	m2	m1	m0
F=0	B14	B13	B12	B11	B10	B9	B8	B7	B6	B5	B4	B3	B2	B1	B0



**Example of floating point format**

```
e3-e0 4-bit signed exponent.
-8..+7 (binary 1000 .. 0111)
m10-m0 11-bit signed mantissa.
-1024..+1023 (binary
100000000000..011111111111)
```

A signed number should be represented as a two complement binary number, like below:

Value Binary

```
-8 1000
-7 1001
..
-2 1110
-1 1111
0 0000
1 0001
2 0010
..
6 0110
7 0111
```

The value represented by the EInt floating point format is  $m \cdot 10^e$ .

To convert a value from the EInt floating point format to a floating point value, use the formula above.

To convert a floating point value to the EInt floating point format, see the code float\_to\_eint below.

**Example**

The number 1.23 would be represented by this in EInt

```
F EEEE MMMMMMMMMMMM
1 1110 00001111011
F=1 -> Eint
E=-2
M=123
```

The value is then  $123 \times 10^{-2} = 1.23$

**Example of 15-bit fixed point format**

The value 72.0 can be represented as the fixed point number 72. It is within the range 0-32767, which means that the 15-bit fixed point format may be used.

The value will then be represented as:

```
B15 B14 B13 B12 B11 B10 B9 B8 B7 B6 B5 B4 B3 B2 B1 B0
0 0 0 0 0 0 0 0 0 1 0 0 1 0 0 0
```

Where bit 15 indicates that we are using the fixed point format (F=0).

## Programming example:

```

typedef struct
{
    int m:11; // mantissa, -1024..1023
    int e: 4; // exponent -8..7
    unsigned int f: 1; // format, 1->special emoint format
}    eint16;
//-----
unsigned short int float_to_eint16(float value)
{
    eint16 etmp;
    int dec=0;

    while (floor(value) != value && dec<16)
    {
        dec++; value*=10;
    }
    if (value>=0 && value<=32767 && dec==0)
        *(short int *)&etmp=(short int)value;
    else if (value>=-1000 && value<0 && dec==0)
    {
        etmp.e=0;
        etmp.f=1;
        etmp.m=(short int)value;
    }
    else
    {
        etmp.m=0;
        etmp.f=1;
        etmp.e=-dec;
        if (value>=0)
            etmp.m=1; // Set sign
        else
            etmp.m=-1; // Set sign
        value=fabs(value);
        while (value>1000)
        {
            etmp.e++; // increase exponent
            value=value/10;
        }
        value+=0.5; // round
        etmp.m=etmp.m*value; // make signed
    }
    return (*(unsigned short int *)&etmp);
}
//-----
float eint16_to_float(unsigned short int value)
{
    float f;
    eint16 evalue;

    evalue=(eint16 *)&value;
    if (evalue.f)
    {
        if (evalue.e>=0)
            f=(int)evalue.m*pow10(evalue.e);
        else
            f=(int)evalue.m/pow10(abs(evalue.e));
    }
    else
        f=value;

    return f;
}
//-----

```

# SECTION 11

## Functional Description

This chapter describes the menus and parameters in the software. You will find a short description of each function and information about default values, ranges, etc. There are also tables containing communication information. You will find the Modbus, DeviceNet, EtherCAT and Fieldbus address for each parameter as well as the enumeration for the data.

**Note** Functions marked with the sign  cannot be changed during Run Mode.

### Description of table layout

<div style="border: 2px solid black; padding: 2px; display: inline-block;">             Menu no.    Menu name           </div>		
Default:		
Selection or range	Integer value of selection	Description

### Resolution of settings

The resolution for all range settings described in this chapter is 3 significant digits. Exceptions are speed values which are presented with 4 significant digits. Table 23 shows the resolutions for 3 significant digits.

*Table 23*

3 Digit	Resolution
0.01-9.99	0.01
10.0-99.9	0.1
100-999	1
1000-9990	10
10000-99900	100

## 11-1 Preferred View [100]

This menu is displayed at every power-up. During operation, the menu [100] will automatically be displayed when the keyboard is not operated for 5 minutes. The automatic return function will be switched off when the Toggle and Stop key is pressed simultaneously. As default it displays the reference and torque values.



Menu [100], Preferred View displays the settings made in menu [110], 1st line, and [120], 2nd line. See Fig. 62.

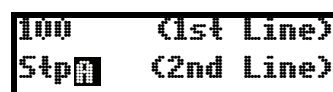

*Fig. 62 Display functions*

### 11-1-1 1st Line [110]

Sets the content of the upper row in the menu [100] Preferred View.

<div style="border: 2px solid black; padding: 5px; display: inline-block;"> <b>110 1st Line</b>  <b>Stp  Process Val</b> </div>		
Default:	Process Val	
Dependent on menu		
Process Val	0	Process value
Speed	1	Speed
Torque	2	Torque
Process Ref	3	Process reference
Shaft Power	4	Shaft power
EI Power	5	Electrical power
Current	6	Current
Output volt	7	Output voltage
Frequency	8	Frequency
DC Voltage	9	DC voltage
Heatsink Tmp	10	Heatsink temperature
Motor Temp	11	Motor temperature
VSD Status	12	VSD status
Run Time	13	Run Time
Energy	14	Energy
Mains Time	15	Mains time

**Note** The “Motor Temp” is only visible if you have the option PTC/PT100 card installed and a PT100 input is selected in menu [236].

Communication information

Modbus Instance no/ DeviceNet no:	43001
Profibus slot/index	168/160
EtherCAT index (hex)	4bb9*
Fieldbus format	UInt
Modbus format	UInt

\* This is a hexadecimal index number.

### 11-1-2 2nd Line [120]

Sets the content of the lower row in the menu [100] Preferred View. Same selection as in menu [110].

<div style="border: 2px solid black; padding: 5px; display: inline-block;"> <b>120 2nd Line</b>  <b>Stp  Torque</b> </div>	
Default:	Torque

## 11-2 Main Setup [200]

The Main Setup menu contains the most important settings to get the VSD operational and set up for the application. It includes different sub menus concerning the control of the unit, motor data and protection, utilities and automatic resetting of faults. This menu will instantaneously be adapted to build in options and show the required settings.

## 11-2-1 Operation [210]

Selections concerning the used motor, VSD mode, control signals and serial communication are described in this submenu and is used to set the VSD up for the application.

### Language [211]

Select the language used on the LC Display. Once the language is set, this selection will not be affected by the Load Default command.

211 Language		
Stp		English
Default:		English
English	0	English selected
Svenska	1	Swedish selected
Nederlands	2	Dutch selected
Deutsch	3	German selected
Français	4	French selected
Español	5	Spanish selected
Russian	6	Russian selected
Italiano	7	Italian selected
Cesky	8	Czech selected
Turkish	9	Turkish selected

#### Communication information

Modbus Instance no/ DeviceNet no:	43011
Profibus slot/index	168/170
EtherCAT index (hex)	4bc3
Fieldbus format	UInt
Modbus format	UInt

### Select Motor [212]

This menu is used if you have more than one motor in your application. Select the motor to define. It is possible to define up to four different motors, M1 to M4, in the VSD. For parameter set handling including Motor sets M1-M4 see Chapter 11.2.6.

212 Select Motor		
Stp		M1
Default:		M1
M1	0	Motor Data is connected to selected motor.
M2	1	
M3	2	
M4	3	

#### Communication information

Modbus Instance no/ DeviceNet no:	43012
Profibus slot/index	168/171
EtherCAT index (hex)	4bc4
Fieldbus format	UInt
Modbus format	UInt

## Drive Mode [213]

This menu is used to set the control mode for the motor. Settings for the reference signals and read-outs is made in menu Process source, [321].

- Speed Mode offers an accurate control of the motor speed independently of the load. The Speed mode also increases the accuracy of the different analogue output signals that are related to the motor speed. Speed mode can also be used if several motors of same type and size are connected in parallel. Requires all motors to be mechanically connected to the load.
- Torque Mode can be selected for applications where the motor shaft torque needs to be controlled independently of the speed.
- V/Hz Mode, output speed [721] in rpm, is used when several motors in parallel of different type or size are connected or if parallel motors are not mechanically connected to the load.

		213 Drive Mode Stop Speed
Default:		Speed
Speed	0	The VSD is speed controlled. Reference given= speed reference with ramp. Speed and torque limits can be set. Using "direct torque control" as motor control method.
Torque	1	The VSD is torque controlled. Reference given= torque reference without ramp. Speed and torque limit can be set. Using "direct torque control" as motor control method. <b>Note</b> No ramps active in the VSD. Care must be taken.
V/Hz	2	All control loops are related to frequency control. <b>Note</b> All the functions and menu read-outs with regard to speed and rpm (e.g. Max Speed = 1500 rpm, Min Speed=0 rpm, etc.) remain speed and rpm, although they represent the output frequency.

### Communication information

Modbus Instance no/ DeviceNet no:	43013
Profibus slot/index	168/172
EtherCAT index (hex)	4bc5
Fieldbus format	UInt
Modbus format	UInt

## Reference control [214]

To control the speed of the motor, the VSD needs a reference signal. This reference signal can be controlled by a remote source from the installation, the keyboard of the VSD, or by serial or fieldbus communication. Select the required reference control for the application in this menu.

		214 Ref Control Stop Remote
Default:		Remote
Remote	0	The reference signal comes from the analogue inputs of the terminal strip (terminals 1-22).
Keyboard	1	Reference is set with the + and - keys on the Control Panel. Can only be done in menu Set/View reference [310].

214 Ref Control Stp <input type="checkbox"/> Remote <input type="checkbox"/>		
Com	2	The reference is set via the serial communication (RS 485, Fieldbus.) See section section 10-5 for further information.
Option	3	The reference is set via an option. Only available if the option can control the reference value.

**Note** If the reference is switched from Remote to Keyboard, the last remote reference value will be the default value for the control panel.

#### Communication information

Modbus Instance no/ DeviceNet no:	43014
Profibus slot/index	168/173
EtherCAT index (hex)	4bc6
Fieldbus format	UInt
Modbus format	UInt

### Run/Stop Control [215]

This function is used to select the source for run and stop commands. Start/stop via analogue signals can be achieved by combining a few functions. This is described in the Chapter SECTION 7 page 53.

215 Run/Stop Ctrl Stp <input type="checkbox"/> Remote <input type="checkbox"/>		
Default:		Remote
Remote	0	The start/stop signal comes from the digital inputs of the terminal strip (terminals 1-22).
Keyboard	1	Start and stop is set on the Control Panel.
Com	2	The start/stop is set via the serial communication (RS 485, Fieldbus.) See Fieldbus or RS232/485 option manual for details.
Option	3	The start/stop is set via an option.

#### Communication information

Modbus Instance no/ DeviceNet no:	43015
Profibus slot/index	168/174
EtherCAT index (hex)	4bc7
Fieldbus format	UInt
Modbus format	UInt

### Reset Control [216]

When the VSD is stopped due to a failure, a reset command is required to make it possible to restart the VSD. Use this function to select the source of the reset signal.

216 Reset Ctrl Stp <input type="checkbox"/> Remote <input type="checkbox"/>		
Default:		Remote
Remote	0	The command comes from the inputs of the terminal strip (terminals 1-22).
Keyboard	1	The command comes from the command keys of the Control Panel.

Com	2	The command comes from the serial communication (RS 485, Fieldbus).
Remote + Keyb	3	The command comes from the inputs of the terminal strip (terminals 1-22) or the keyboard.
Com + Keyb	4	The command comes from the serial communication (RS485, Fieldbus) or the keyboard.
Rem+Keyb+Com	5	The command comes from the inputs of the terminal strip (terminals 1-22), the keyboard or the serial communication (RS485, Fieldbus).
Option	6	The command comes from an option. Only available if the option can control the reset command.

Communication information

Modbus Instance no/ DeviceNet no:	43016
Profibus slot/index	168/175
EtherCAT index (hex)	4bc8
Fieldbus format	UInt
Modbus format	UInt

Local/Remote key function [217]

The Toggle key on the keyboard, see section 9-2-5, page 70, has two functions and is activated in this menu. As default the key is just set to operate as a Toggle key that moves you easily through the menus in the toggle loop. The second function of the key allows you to easily swap between Local and normal operation (set up via [214] and [215]) of the VSD. Local mode can also be activated via a digital input. If both [2171] and [2172] is set to Standard, the function is disabled.

<b>2171 LockCtrl</b> Stp <input type="checkbox"/> Standard		
Default:	Standard	
Standard	0	Local reference control set via [214]
Remote	1	Local reference control via remote
Keyboard	2	Local reference control via keyboard
Com	3	Local reference control via communication

Communication information

Modbus Instance no/ DeviceNet no:	43009
Profibus slot/index	168/168
EtherCAT index (hex)	4bc1
Fieldbus format	UInt
Modbus format	UInt

<b>2172 LockCtrl</b> Stp <input type="checkbox"/> Standard		
Default:	Standard	
Standard	0	Local Run/Stop control set via [215]
Remote	1	Local Run/Stop control via remote
Keyboard	2	Local Run/Stop control via keyboard
Com	3	Local Run/Stop control via communication



Communication information

Modbus Instance no/ DeviceNet no:	43010
Profibus slot/index	168/169
EtherCAT index (hex)	4bc2 x h
Fieldbus format	UInt
Modbus format	UInt

Lock Code? [218]

To prevent the keyboard being used or to change the setup of the VSD and/or process control, the keyboard can be locked with a password. This menu, Lock Code [218], is used to lock and unlock the keyboard. Enter the password “291” to lock/unlock the keyboard operation. If the keyboard is not locked (default) the selection “Lock Code?” will appear. If the keyboard is already locked, the selection “Unlock Code?” will appear.

When the keyboard is locked, parameters can be viewed but not changed. The reference value can be changed and the VSD can be started, stopped and reversed if these functions are set to be controlled from the keyboard.

	
Default:	0
Range:	0–9999

Rotation [219]

Overall limitation of motor rotation direction

This function limits the overall rotation, either to left or right or both directions. This limit is prior to all other selections, e.g.: if the rotation is limited to right, a Run-Left command will be ignored. To define left and right rotation we assume that the motor is connected U-U, V-V and W-W.

Speed Direction and Rotation

The speed direction can be controlled by:

- RunR/RunL commands on the control panel.
- RunR/RunL commands on the terminal strip (terminals 1-22).
- Via the serial interface options.
- The parameter sets.

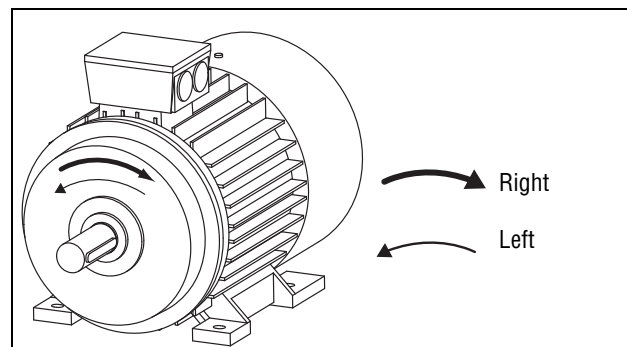

Fig. 63 Rotation

In this menu you set the general rotation for the motor.

<div style="border: 2px solid black; padding: 5px; display: inline-block;"> <b>210 Rotation</b>  <b>Stop</b>                      <b>R+L</b> </div>		
Default:		R + L
R	1	Speed direction is limited to right rotation. The input and key RunL are disabled.
L	2	Speed direction is limited to left rotation. The input and key RunR are disabled.
R+L	3	Both speed directions allowed.

Communication information

Modbus Instance no/ DeviceNet no:	43019
Profibus slot/index	168/178
EtherCAT index (hex)	4bcb
Fieldbus format	UInt
Modbus format	UInt

### 11-2-2 Remote Signal Level/Edge [21A]

In this menu you select the way to control the inputs for RunR, RunL, Stop and Reset that are operated via the digital inputs on the terminal strip. The inputs are default set for level-control, and will be active as long as the input is made and kept high. When edge-control is selected, the input will be activated by the low to high transition of the input.

<div style="border: 2px solid black; padding: 5px; display: inline-block;"> <b>21A Level/Edge</b>  <b>Stop</b>                      <b>Level</b> </div>		
Default:		Level
Level	0	The inputs are activated or deactivated by a continuous high or low signal. Is commonly used if, for example, a PLC is used to operate the VSD.
Edge	1	The inputs are activated by a transition; for Run and Reset from "low" to "high", for Stop from "high" to "low".

Communication information

Modbus Instance no/ DeviceNet no:	43020
Profibus slot/index	168/179
EtherCAT index (hex)	4bcc
Fieldbus format	UInt
Modbus format	UInt

 **Caution** Level controlled inputs DO NOT comply with the Machine Directive if the inputs are directly used to start and stop the machine.

**Note** Edge controlled inputs can comply with the Machine Directive (see the Chapter SECTION 8 page 65) if the inputs are directly used to start and stop the machine.

### 11-2-3 Mains supply voltage [21B]

**Warning** ⚠ This menu must be set according to the VSD product label and the supply voltage used. Wrong setting might damage the VSD or brake resistor.

In this menu the nominal mains supply voltage connected to the VSD can be selected. The setting will be valid for all parameter sets. The default setting, Not defined, is never selectable and is only visible until a new value is selected.

Once the supply voltage is set, this selection will not be affected by the Load Default command [243].

Brake chopper activation level is adjusted using the setting of [21B].

**Note** The setting is affected by the Load from CP command [245] and if loading parameter file via EmoSoftCom.

21B Supply Volts Stp <input type="checkbox"/> Not defined		
Default:		Not defined
Not Defined	0	Inverter default value used. Only valid if this parameter is never set.
220-240 V	1	Only valid for SX-F-4 (400V)
380-415 V	3	Only valid for SX-F-4 (400V)
440-480 V	4	Only valid for SX-F-4 (400V)
500-525 V	5	Only valid for SX-F-6 (690V)
550-600 V	6	Only valid for SX-F-6 (690V)
660-690 V	7	Only valid for SX-F-6 (690V)

#### Communication information

Modbus Instance no/ DeviceNet no:	43381
Profibus slot/index	170/30
EtherCAT index (hex)	4d35
Fieldbus format	UInt
Modbus format	UInt

### 11-2-4 Motor Data [220]

In this menu you enter the motor data to adapt the VSD to the connected motor. This will increase the control accuracy as well as different read-outs and analogue output signals.

Motor M1 is selected as default and motor data entered will be valid for motor M1. If you have more than one motor you need to select the correct motor in menu [212] before entering motor data.

**Note** The parameters for motor data cannot be changed during run mode.

**Note** The default settings are for a standard 4-pole motor according to the nominal power of the VSD.



**Note** Parameter set cannot be changed during run if the sets is set for different motors.

**Note** Motor Data in the different sets M1 to M4 can be revert to default setting in menu [243], Default>Set.

 **Warning** Enter the correct motor data to prevent dangerous situations and assure correct control.

## Motor Voltage [221]

Set the nominal motor voltage.

	<b>221 Motor Volts</b> Stp  M1: 400V
Default:	400 V for SX-F -4 690 V for SX-F -6
Range:	100-700 V
Resolution	1 V



**Note** The Motor Volts value will always be stored as a 3 digit value with a resolution of 1 V.

Communication information

Modbus Instance no/ DeviceNet no:	43041
Profibus slot/index	168/200
EtherCAT index (hex)	4be1
Fieldbus format	Long, 1=0.1 V
Modbus format	EInt

## Motor Frequency [222]

Set the nominal motor frequency



	<b>222 Motor Freq</b> Stp  M1: 50Hz
Default:	50 Hz
Range:	24-300 Hz
Resolution	1 Hz

Communication information

Modbus Instance no/ DeviceNet no:	43042
Profibus slot/index	168/201
EtherCAT index (hex)	4be2
Fieldbus format	Long, 1=1 Hz
Modbus format	EInt

## Motor Power [223]

Set the nominal motor power. If parallel motors, set the value as sum of motors power

	<b>223 Motor Power</b> Stp  M1: (P <sub>NOM</sub> )kW
Default:	P <sub>NOM</sub> VSD
Range:	1W-150% x P <sub>NOM</sub>
Resolution	3 significant digits

**Note** The Motor Power value will always be stored as a 3 digit value in W up to 999 W and in kW for all higher powers.

#### Communication information

Modbus Instance no/ DeviceNet no:	43043
Profibus slot/index	168/202
EtherCAT index (hex)	4be3
Fieldbus format	Long, 1=1 W
Modbus format	EInt

$P_{NOM}$  is the nominal VSD power.

### Motor Current [224]

Set the nominal motor current. If parallel motors set the sum of the motor currents.

	<b>224 Motor Curr</b> Stp [M1]: (I <sub>MOT</sub> )A
Default:	I <sub>MOT</sub> (see note section 11-2-4, page 91)
Range:	25 - 150% x I <sub>NOM</sub>

#### Communication information

Modbus Instance no/ DeviceNet no:	43044
Profibus slot/index	168/203
EtherCAT index (hex)	4be4
Fieldbus format	Long, 1=0.1 A
Modbus format	EInt

I<sub>MOT</sub> is the nominal VSD current.

 **Warning** Do not connect motors with less than 25% of the nominal power of the VSD. This may disrupt the control of the motor.

### Motor Speed [225]

Set the nominal asynchronous motor speed.

	<b>225 Motor Speed</b> Stp [M1]: (n <sub>MOT</sub> )rpm
Default:	n <sub>MOT</sub> (see note section 11-2-4, page 91)
Range:	50 - 18000 rpm
Resolution	1 rpm, 4 sign digits

 **Warning** Do NOT enter a synchronous (no-load) motor speed.

**Note** Maximum speed [343] is not automatically changed when the motor speed is changed.

**Note** Entering a wrong, too low value can cause a dangerous situation for the driven application due to high speeds.

## Communication information

Modbus Instance no/ DeviceNet no:	43045
Profibus slot/index	168/204
EtherCAT index (hex)	4be5
Fieldbus format	UInt 1=1 rpm
Modbus format	UInt

## Motor Poles [226]

When the nominal speed of the motor is  $\leq 500$  rpm, the additional menu for entering the number of poles, [226], appears automatically. In this menu the actual pole number can be set which will increase the control accuracy of the VSD.



	226 Motor Poles Stp  M1: 4
Default:	4
Range:	2-144

## Communication information

Modbus Instance no/ DeviceNet no:	43046
Profibus slot/index	168/205
EtherCAT index (hex)	4be6
Fieldbus format	Long, 1=1 pole
Modbus format	EInt

Motor Cos  $\varphi$  [227]

Set the nominal Motor cosphi (power factor).



	227 Motor Cos $\varphi$ Stp  M1: Cos $\varphi_{NOM}$
Default:	COS $\varphi_{NOM}$ (see note section 11-2-4, page 91)
Range:	0.50 - 1.00

## Communication information

Modbus Instance no/ DeviceNet no:	43047
Profibus slot/index	168/206
EtherCAT index (hex)	4be7
Fieldbus format	Long, 1=0.01
Modbus format	EInt

## Motor ventilation [228]

Parameter for setting the type of motor ventilation. Affects the characteristics of the  $I^2t$  motor protection by lowering the actual overload current at lower speeds.

	228 Motor Vent Stp  M1: Self
Default:	Self

None	0	Limited $I^2t$ overload curve.
Self	1	Normal $I^2t$ overload curve. Means that the motor stands lower current at low speed.
Forced	2	Expanded $I^2t$ overload curve. Means that the motor stands almost the whole current also at lower speed.

## Communication information

Modbus Instance no/ DeviceNet no:	43048
Profibus slot/index	168/207
EtherCAT index (hex)	4be8
Fieldbus format	UInt
Modbus format	UInt

When the motor has no cooling fan, None is selected and the current level is limited to 55% of rated motor current.

With a motor with a shaft mounted fan, Self is selected and the current for overload is limited to 87% from 20% of synchronous speed. At lower speed, the overload current allowed will be smaller.

When the motor has an external cooling fan, Forced is selected and the overload current allowed starts at 90% from rated motor current at zero speed, up to nominal motor current at 70% of synchronous speed.

Fig. 64 shows the characteristics with respect for Nominal Current and Speed in relation to the motor ventilation type selected.

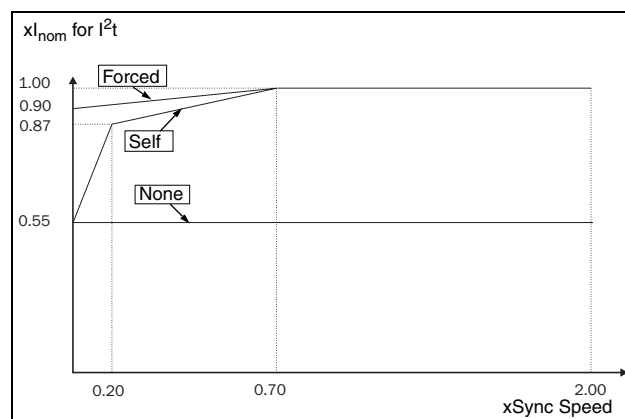

Fig. 64  $I^2t$  curves

## Motor Identification Run [229]

This function is used when the VSD is put into operation for the first time. To achieve an optimal control performance, fine tuning of the motor parameters using a motor ID run is needed. During the test run the display shows "Test Run" blinking.

To activate the Motor ID run, select either "Short" or "Extended" and press Enter. Then press RunL or RunR on the control panel to start the ID run. If menu [219] Rotation is set to L the RunR key is inactive and vice versa. The ID run can be aborted by giving a Stop command via the control panel or Enable input. The parameter will automatically return to OFF when the test is completed. The message "Test Run OK!" is displayed. Before the VSD can be operated normally again, press the STOP/RESET key on the control panel.

During the Short ID run the motor shaft does not rotate. The VSD measures the rotor and stator resistance.

During the Extended ID run the motor is powered on and rotates. The VSD measures the rotor and stator resistance as well as the induction and the inertia for the motor.

		<b>229 Motor ID-Run</b> StpM1: Off
Default:		Off, see Note
Off	0	Not active
Short	1	Parameters are measured with injected DC current. No rotation of the shaft will occur.
Extended	2	Additional measurements, not possible to perform with DC current, are done directly after a short ID run. The shaft will rotate and must be disconnected from the load.

#### Communication information

Modbus Instance no/ DeviceNet no:	43049
Profibus slot/index	168/208
EtherCAT index (hex)	4be9
Fieldbus format	UInt
Modbus format	UInt

 **Warning** During the extended ID RUN, the motor will rotate. Take safety measures to avoid unforeseen dangerous situations.

**Note** To run the VSD it is not mandatory for the ID RUN to be executed, but without it the performance will not be optimal.

**Note** If the ID Run is aborted or not completed the message "Interrupted!" will be displayed. The previous data do not need to be changed in this case. Check that the motor data are correct.

## Encoder Feedback [22B]

Only visible if the Encoder option board is installed. This parameter enables or disables the encoder feedback from the motor to the VSD.

		<b>22B Encoder</b> StpM1: Off
Default:		Off
On	0	Encoder feedback enabled
Off	1	Encoder feedback disabled



#### Communication information

Modbus Instance no/ DeviceNet no:	43051
Profibus slot/index	168/210
EtherCAT index (hex)	4beb
Fieldbus format	UInt
Modbus format	UInt



## Encoder Pulses [22C]

Only visible if the Encoder option board is installed. This parameter describes the number of pulses per rotation for your encoder, i.e. it is encoder specific. For more information please see the encoder manual.



	<b>22C Enc Pulses</b> Stp  M1: 1024
Default:	1024
Range:	5–16384

### Communication information

Modbus Instance no/ DeviceNet no:	43052
Profibus slot/index	168/211
EtherCAT index (hex)	4bec
Fieldbus format	Long, 1=1 pulse
Modbus format	EInt

## Encoder Speed [22D]

Only visible if the Encoder option board is installed. This parameter shows the measured motor speed. To check if the encoder is correctly installed, set Encoder feedback [22B] to Off, run the VSD at any speed and compare with the value in this menu. The value in this menu [22D] should be about the same as the motor speed [712]. If you get the wrong sign for the value, swap encoder input A and B.



	<b>22D Enc Speed</b> Stp  M1: XXrpm
Unit:	rpm
Resolution:	speed measured via the encoder

### Communication information

Modbus Instance no/ DeviceNet no:	42911
Profibus slot/index	168/70
EtherCAT index (hex)	4b5f
Fieldbus format	Int
Modbus format	Int

## Encoder Pulse counter [22F]

Only visible if the encoder option is installed. Add menu/parameter for accumulated QEP (Quadrature Encoder Pulse) encoder pulses. Can be preset to any value within format used (Int = 2 byte, Long = 4 byte).

	<b>22F Enc Puls Ctr</b> Stp  M1: 0
Default:	0
Resolution	1

## Communication information

Modbus Instance no/ DeviceNet no:	42912
Profibus slot/index	168/71
EtherCAT index (hex)	4b60
Fieldbus format	Long, 1=1 quad encoder pulse
Modbus format	Int

**Note** For a 1024 pulse encoder [22F] will count  $1024 * 4 = 4096$  pulse per turn.

### 11-2-5 Motor Protection [230]

This function protects the motor against overload based on the standard IEC60947-4-2.

#### Motor I<sup>2</sup>t Type [231]

The motor protection function makes it possible to protect the motor from overload as published in the standard IEC 60947-4-2. It does this using Motor I<sup>2</sup>t Current, [232] as a reference. The Motor I<sup>2</sup>t Time [233] is used to define the time behaviour of the function. The current set in [232] can be delivered infinite in time. If for instance in [233] a time of 1000 s is chosen the upper curve of Fig. 65 is valid. The value on the x-axis is the multiple of the current chosen in [232]. The time [233] is the time that an overloaded motor is switched off or is reduced in power at 1.2 times the current set in [232].

		<b>231 Mot I<sup>2</sup>t Type</b> Stop: Trip
Default:		Trip
Off	0	I <sup>2</sup> t motor protection is not active.
Trip	1	When the I <sup>2</sup> t time is exceeded, the VSD will trip on "Motor I <sup>2</sup> t".
Limit	2	This mode helps to keep the inverter running when the Motor I <sup>2</sup> t function is just before tripping the VSD. The trip is replaced by current limiting with a maximum current level set by the value out of the menu [232]. In this way, if the reduced current can drive the load, the VSD continues running.

## Communication information

Modbus Instance no/ DeviceNet no:	43061
Profibus slot/index	168/220
EtherCAT index (hex)	4bf5
Fieldbus format	UInt
Modbus format	UInt

**Note** When Mot I<sup>2</sup>t Type=Limit, the VSD can control the speed < MinSpeed to reduce the motor current.

#### Motor I<sup>2</sup>t Current [232]

Sets the current limit for the motor I<sup>2</sup>t protection.

		<b>232 Mot I<sup>2</sup>t Curr</b> Stop: 100%
Default:		100% of I <sub>MOT</sub>
Range:		0–150% of I <sub>MOT</sub> (set in menu [224])

Communication information

Modbus Instance no/ DeviceNet no:	43062
Profibus slot/index	168/221
EtherCAT index (hex)	4bf6
Fieldbus format	Long, 1=1%
Modbus format	EInt

**Note** When the selection Limit is set in menu [231], the value must be above the no-load current of the motor.

### Motor I<sup>2</sup>t Time [233]

Sets the time of the I<sup>2</sup>t function. After this time the limit for the I<sup>2</sup>t is reached if operating with 120% of the I<sup>2</sup>t current value. Valid when start from 0 rpm.

**Note** Not the time constant of the motor.

<div style="border: 2px solid black; padding: 5px; display: inline-block;">                 233 Mot I<sup>2</sup>t Time                  Stop time: 60s             </div>	
Default:	60 s
Range:	60–1200 s

Communication information

Modbus Instance no/ DeviceNet no:	43063
Profibus slot/index	168/222
EtherCAT index (hex)	4bf7
Fieldbus format	Long, 1=1 s
Modbus format	EInt

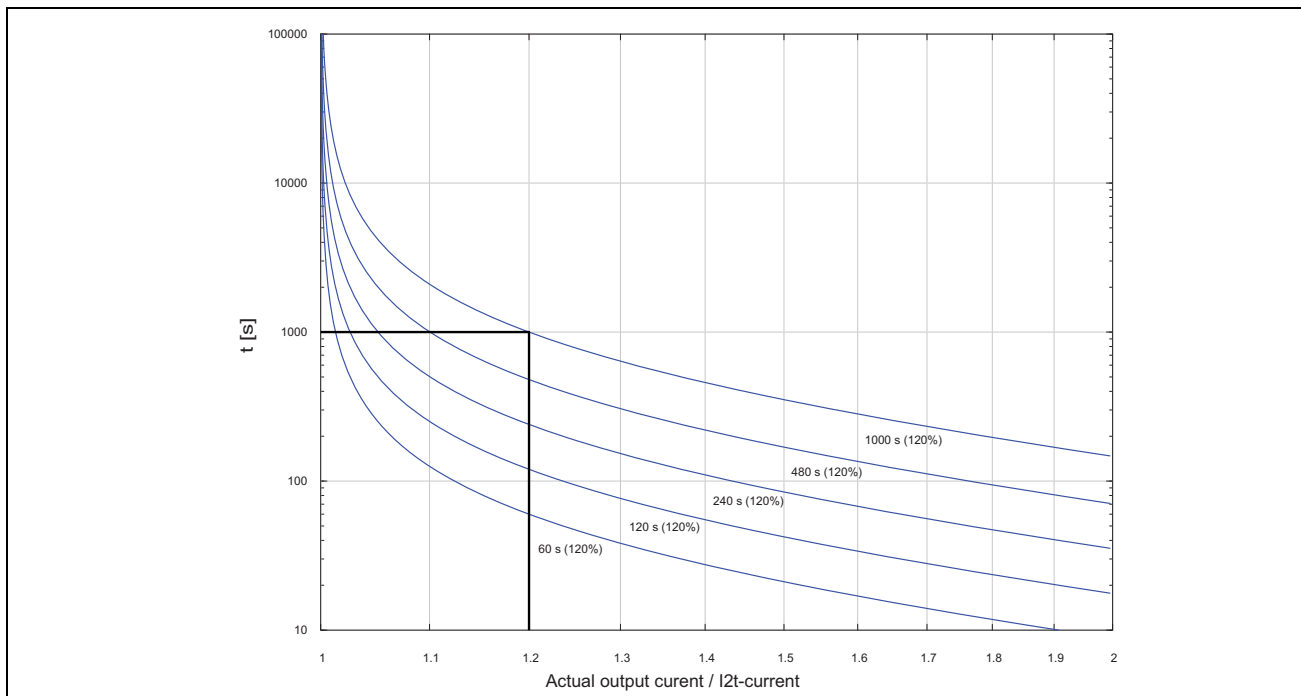

Fig. 65 I<sup>2</sup>t function

Fig. 65 shows how the function integrates the square of the motor current according to the Mot I<sup>2</sup>t Curr [232] and the Mot I<sup>2</sup>t Time [233].

When the selection Trip is set in menu [231] the VSD trips if this limit is exceeded.

When the selection Limit is set in menu [231] the VSD reduces the torque if the integrated value is 95% or closer to the limit, so that the limit cannot be exceeded.

**Note** If it is not possible to reduce the current, the VSD will trip after exceeding 110% of the limit.

**Example**

In Fig. 65 the thick grey line shows the following example.

- Menu [232] Mot I<sup>2</sup>t Curr is set to 100%.  
1.2 x 100% = 120%
- Menu [233] Mot I<sup>2</sup>t Time is set to 1000 s.

This means that the VSD will trip or reduce after 1000 s if the current is 1.2 times of 100% nominal motor current.

**Thermal Protection [234]**

Only visible if the PTC/PT100 option board is installed. Set the PTC input for thermal protection of the motor. The motor thermistors (PTC) must comply with DIN 44081/44082. Please refer to the manual for the PTC/PT100 option board.

Menu [234] PTC contains functions to enable or disable the PTC input. Here you can select and activate PTC and/or PT100.

		<b>234 Thermal Prot</b> <b>Stp <input type="checkbox"/> Off</b>
Default:		Off
Off	0	PTC and PT100 motor protection are disabled.
PTC	1	Enables the PTC protection of the motor via the insulated option board.
PT100	2	Enables the PT100 protection for the motor via the insulated option board.
PTC+PT100	3	Enables the PTC protection as well as the PT100 protection for the motor via the insulated option board.

Communication information

Modbus Instance no/ DeviceNet no:	43064
Profibus slot/index	168/223
EtherCAT index (hex)	4bf8
Fieldbus format	UInt
Modbus format	UInt

**Note** PTC option and PT100 selections can only be selected in menu [234] if the option board is mounted.

**Note** If you select the PTC option, the PT100 inputs are ignored

## Motor Class [235]

Only visible if the PTC/PT100 option board is installed. Set the class of motor used. The trip levels for the PT100 sensor will automatically be set according to the setting in this menu.

		<b>235 Mot Class</b> Step <input type="checkbox"/> F 140°C
Default:	F 140°C	
A 100°C	0	
E 115°C	1	
B 120°C	2	
F 140°C	3	
F Nema 145°C	4	
H 165°C	5	

### Communication information

Modbus Instance no/ DeviceNet no:	43065
Profibus slot/index	168/224
EtherCAT index (hex)	4bf9
Fieldbus format	UInt
Modbus format	UInt

**Note** This menu is only valid for PT 100.

## PT100 Inputs [236]

Sets which of PT100 inputs should be used for thermal protection. Deselecting not used PT100 inputs on the PTC/PT100 option board in order to ignore those inputs, i.e. extra external wiring is not needed if port is not used.

		<b>236 PT100 Inputs</b> Step <input type="checkbox"/> PT100 1+2+3
Default:	PT100 1+2+3	
Selection:	PT100 1, PT100 2, PT100 1+2, PT100 3, PT100 1+3, PT100 2+3, PT100 1+2+3	
PT100 1	1	Channel 1 used for PT100 protection
PT100 2	2	Channel 2 used for PT100 protection
PT100 1+2	3	Channel 1+2 used for PT100 protection
PT100 3	4	Channel 3 used for PT100 protection
PT100 1+3	5	Channel 1+3 used for PT100 protection
PT100 2+3	6	Channel 2+3 used for PT100 protection
PT100 1+2+3	7	Channel 1+2+3 used for PT100 protection

### Communication information

Modbus Instance no/ DeviceNet no:	43066
Profibus slot/index	168/225
EtherCAT index (hex)	4bfa
Fieldbus format	UInt
Modbus format	UInt

**Note** This menu is only valid for PT100 thermal protection if PT100 is enabled in menu [234].

## Motor PTC [237]

For VSD sizes B to D there is optional possibility to directly connect motor PTC (not to be mixed up with PTC/PT100 option board).

In this menu the internal motor PTC hardware option is enabled. This PTC input complies with DIN 44081/44082. Please refer to the manual for the PTC/PT100 option board for electrical specification.

This menu is only visible if a PTC (or resistor <2 kOhm) is connected to terminals X1: 78–79. See Chapter 5.4 and Chapter 5.5.1.

**Note** This function is not related to PTC/PT100 option board.

To enable the function:

1. Connect the thermistor wires to X1: 78–79 or for testing the input, connect a resistor to the terminals. Use resistor value between 50 and 2000 ohm.

Menu [237] will now appear.

2. Enable input by setting menu [237] Motor PTC=On.

If enabled and <50 ohm a sensor error trip will occur. The fault message “Motor PTC” is shown.

If the function is disabled and the PTC or resistor is removed, the menu will disappear after the next power on.

		237 Motor PTC Stp <input type="checkbox"/> Off
Default:		Off
Off	0	Motor PTC protection is disabled
On	1	Motor PTC protection is enabled

Communication information

Modbus Instance no/ DeviceNet no:	43067
Profibus slot/index	168/226
EtherCAT index (hex)	4bfb
Fieldbus format	UInt
Modbus format	UInt

**Note** This option is only available for SX-D40P7 to SX-D4037

## 11-2-6 Parameter Set Handling [240]

There are four different parameter sets available in the VSD. These parameter sets can be used to set the VSD up for different processes or applications such as different motors used and connected, activated PID controller, different ramp time settings, etc.

A parameter set consists of all parameters with the exception of the menu [211] Language, [217] Local Remote, [218] Lock Code, [220] Motor Data, [241] Select Set, [260] Serial Communication and [21B] Mains supply voltage.

**Note** Actual timers are common for all sets. When a set is changed the timer functionality will change according to the new set, but the timer value will stay unchanged.

### Select Set [241]

Here you select the parameter set. Every menu included in the parameter sets is designated A, B, C or D depending on the active parameter set. Parameter sets can be selected from the keyboard, via the programmable digital inputs or via serial communication. Parameter sets can be changed during

the run. If the sets are using different motors (M1 to M4) the set will be changed only when the motor is stopped.

<div style="border: 2px solid black; padding: 2px; display: inline-block;">           241 Select Set            Stop      A         </div>		
Default:		A
Selection:		A, B, C, D, DigIn, Com, Option
A	0	Fixed selection of one of the 4 parameter sets A, B, C or D.
B	1	
C	2	
D	3	
DigIn	4	Parameter set is selected via a digital input. Define which digital input in menu [520], Digital inputs.
Com	5	Parameter set is selected via serial communication.
Option	6	The parameter set is set via an option. Only available if the option can control the selection.

#### Communication information

Modbus Instance no/ DeviceNet no:	43022
Profibus slot/index	168/181
EtherCAT index (hex)	4bce
Fieldbus format	UInt
Modbus format	UInt

The active set can be viewed with function [721] VSD status.

**Note** Parameter set cannot be changed during run if the parameter set includes change of the motor set (M2-M4).

Prepare parameter Set when different Motor data M1-M4:

1. Select desired parameter Set to be set in [241] A-D.
2. Select Motor Set [212] if other than the default Set M1.
3. Set relevant motor data in the Menu group [220].
4. Set other desired parameter settings to belong to this parameter Set.

To prepare a Set for another motor, repeat these steps.

### Copy Set [242]

This function copies the content of a parameter set into another parameter set.

<div style="border: 2px solid black; padding: 2px; display: inline-block;">           242 Copy Set            Stop      A&gt;B         </div>		
Default:		A>B
A>B	0	Copy set A to set B
A>C	1	Copy set A to set C

A>D	2	Copy set A to set D
B>A	3	Copy set B to set A
B>C	4	Copy set B to set C
B>D	5	Copy set B to set D
C>A	6	Copy set C to set A
C>B	7	Copy set C to set B
C>D	8	Copy set C to set D
D>A	9	Copy set D to set A
D>B	10	Copy set D to set B
D>C	11	Copy set D to set C

## Communication information

Modbus Instance no/ DeviceNet no:	43021
Profibus slot/index	168/180
EtherCAT index (hex)	4bcd
Fieldbus format	UInt
Modbus format	UInt

**Note** The actual value of menu [310] will not be copied into the other set.

A>B means that the content of parameter set A is copied into parameter set B.



## Load Default Values Into Set [243]

With this function three different levels (factory settings) can be selected for the four parameter sets. When loading the default settings, all changes made in the software are set to factory settings. This function also includes selections for loading default settings to the four different Motor Data Sets.

		243 DefaultSet Stop
Default:		A
A	0	Only the selected parameter set will revert to its default settings.
B	1	
C	2	
D	3	
ABCD	4	All four parameter sets will revert to the default settings.
Factory	5	All settings, except [211], [221]-[22D], [261], [3A1] and [923], will revert to the default settings.
M1	6	Only the selected motor set will revert to its default settings.
M2	7	
M3	8	
M4	9	
M1234	10	All four motor sets will revert to default settings.

### Communication information

Modbus Instance no/ DeviceNet no:	43023
Profibus slot/index	168/182
EtherCAT index (hex)	4bcf
Fieldbus format	UInt
Modbus format	UInt

**Note** Trip log hour counter and other VIEW ONLY menus are not regarded as settings and will be unaffected.

**Note** “Factory” is selected, the message “Sure?” is displayed. Press the + key to display “Yes” and then Enter to confirm.

**Note** The parameters in menu [220], Motor data, are not affected by loading defaults when restoring parameter sets A–D.

## Copy All Settings to Control Panel [244]

All the settings can be copied into the control panel including the motor data. Start commands will be ignored during copying.

		244 Copy to CP Stop No Copy
Default:		No Copy
No Copy	0	Nothing will be copied
Copy	1	Copy all settings

### Communication information

Modbus Instance no/ DeviceNet no:	43024
Profibus slot/index	168/183
EtherCAT index (hex)	4bd0

Fieldbus format	UInt
Modbus format	UInt

**Note** The actual value of menu [310] will not be copied into control panel memory set.

## Load Settings from Control Panel [245]

This function can load all four parameter sets from the control panel to the VSD. Parameter sets from the source VSD are copied to all parameter sets in the target VSD, i.e. A to A, B to B, C to C and D to D.

Start commands will be ignored during loading.

		 <div style="border: 2px solid black; padding: 2px; display: inline-block;"> <b>245 Load from CP</b>  <b>Stp</b>      <b>No Copy</b> </div>
Default:		No Copy
No Copy	0	Nothing will be loaded.
A	1	Data from parameter set A is loaded.
B	2	Data from parameter set B is loaded.
C	3	Data from parameter set C is loaded.
D	4	Data from parameter set D is loaded.
ABCD	5	Data from parameter sets A, B, C and D are loaded.
A+Mot	6	Parameter set A and Motor data are loaded.
B+Mot	7	Parameter set B and Motor data are loaded.
C+Mot	8	Parameter set C and Motor data are loaded.
D+Mot	9	Parameter set D and Motor data are loaded.
ABCD+Mot	10	Parameter sets A, B, C, D and Motor data are loaded.
M1	11	Data from motor 1 is loaded.
M2	12	Data from motor 2 is loaded.
M3	13	Data from motor 3 is loaded.
M4	14	Data from motor 4 is loaded.
M1M2M3M4	15	Data from motor 1, 2, 3 and 4 are loaded.
All	16	All data is loaded from the control panel.

### Communication information

Modbus Instance no/ DeviceNet no:	43025
Profibus slot/index	168/184
EtherCAT index (hex)	4bd1
Fieldbus format	UInt
Modbus format	UInt

**Note** Loading from the control panel will not affect the value in menu [310].

## 11-2-7 Trip Autoreset/Trip Conditions [250]

The benefit of this feature is that occasional trips that do not affect the process will be automatically reset. Only when the failure keeps on coming back, recurring at defined times and therefore cannot be solved by the VSD, will the unit give an alarm to inform the operator that attention is required.

For all trip functions that can be activated by the user you can select to control the motor down to zero speed according to set deceleration ramp to avoid water hammer.

Also see section 12-2, page 261.

### Autoreset example:

In an application it is known that the main supply voltage sometimes disappears for a very short time, a so-called “dip”. That will cause the VSD to trip an “Undervoltage alarm”. Using the Autoreset function, this trip will be acknowledged automatically.

- Enable the Autoreset function by making the reset input continuously high.
- Activate the Autoreset function in the menu [251], Number of trips.
- Select in menus [252] to [25N] the Trip condition that are allowed to be automatically reset by the Autoreset function after the set delay time has expired.

### Number of Trips [251]

Any number set above 0 activates the Autoreset. This means that after a trip, the VSD will restart automatically according to the number of attempts selected. No restart attempts will take place unless all conditions are normal.

If the Autoreset counter (not visible) contains more trips than the selected number of attempts, the Autoreset cycle will be interrupted. No Autoreset will then take place.

If there are no trips for more than 10 minutes, the Autoreset counter decreases by one.

If the maximum number of trips has been reached, the trip message hour counter is marked with an “A”.

If the Autoreset is full then the VSD must be reset by a normal Reset.

#### Example:

- Autoreset = 5
- Within 10 minutes 6 trips occur
- At the 6th trip there is no Autoreset, because the Autoreset trip log contains 5 trips already.
- To reset, apply a normal reset: set the reset input high to low and high again to maintain the Autoreset function. The Autoreset counter is reset (not visible).

	
Default:	0 (no Autoreset)
Range:	0–10 attempts

#### Communication information

Modbus Instance no/ DeviceNet no:	43071
Profibus slot/index	168/230
EtherCAT index (hex)	4bff
Fieldbus format	UInt
Modbus format	UInt

**Note** An auto reset is delayed by the remaining ramp time.

### Over temperature [252]

Delay time starts counting when the fault is gone. When the time delay has elapsed, the alarm will be reset if the function is active.

<div style="border: 2px solid black; padding: 5px; display: inline-block;">           252 Overtemp            Stop Off         </div>		
Default:		Off
Off	0	Off
1-3600	1-3600	1-3600 s

#### Communication information

Modbus Instance no/ DeviceNet no:	43072
Profibus slot/index	168/231
EtherCAT index (hex)	4c00
Fieldbus format	Long, 1=1 s
Modbus format	EInt

**Note** An auto reset is delayed by the remaining ramp time.

### Overvolt D [253]

Delay time starts counting when the fault is gone. When the time delay has elapsed, the alarm will be reset if the function is active.

<div style="border: 2px solid black; padding: 5px; display: inline-block;">           253 Overvolt D            Stop Off         </div>		
Default:		Off
Off	0	Off
1-3600	1-3600	1-3600 s

#### Communication information

Modbus Instance no/ DeviceNet no:	43075
Profibus slot/index	168/234
EtherCAT index (hex)	4c03
Fieldbus format	Long, 1=1 s
Modbus format	EInt

**Note** An auto reset is delayed by the remaining ramp time.

### Overvolt G [254]

Delay time starts counting when the fault is gone. When the time delay has elapsed, the alarm will be reset if the function is active.

<div style="border: 2px solid black; padding: 5px; display: inline-block;">           254 Overvolt G            Stop Off         </div>		
Default:		Off
Off	0	Off
1-3600	1-3600	1-3600 s

## Communication information

Modbus Instance no/ DeviceNet no:	43076
Profibus slot/index	168/235
EtherCAT index (hex)	4c04
Fieldbus format	Long, 1=1 s
Modbus format	EInt

## Overvolt [255]

Delay time starts counting when the fault is gone. When the time delay has elapsed, the alarm will be reset if the function is active.

		
Default:	Off	
Off	0	Off
1-3600	1- 3600	1-3600 s

## Communication information

Modbus Instance no/ DeviceNet no:	43077
Profibus slot/index	168/236
EtherCAT index (hex)	4c05
Fieldbus format	Long, 1=1 s
Modbus format	EInt

## Motor Lost [256]

Delay time starts counting when the fault is gone. When the time delay has elapsed, the alarm will be reset if the function is active

		
Default:	Off	
Off	0	Off
1-3600	1- 3600	1-3600 s

**Note** Only visible when Motor Lost is selected in menu [423].

## Communication information

Modbus Instance no/ DeviceNet no:	43083
Profibus slot/index	168/242
EtherCAT index (hex)	4c0b
Fieldbus format	Long, 1=1 s
Modbus format	EInt

### Locked Rotor [257]

Delay time starts counting when the fault is gone. When the time delay has elapsed, the alarm will be reset if the function is active.

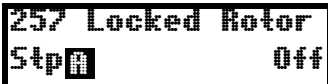
		
Default:		Off
Off	0	Off
1-3600	1-3600	1-3600 s

#### Communication information

Modbus Instance no/ DeviceNet no:	43086
Profibus slot/index	168/245
EtherCAT index (hex)	4c0c
Fieldbus format	Long, 1=1 s
Modbus format	EInt

### Power Fault [258]

Delay time starts counting when the fault is gone. When the time delay has elapsed, the alarm will be reset if the function is active.

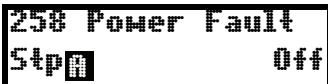
		
Default:		Off
Off	0	Off
1-3600	1-3600	1-3600 s

#### Communication information

Modbus Instance no/ DeviceNet no:	43087
Profibus slot/index	168/246
EtherCAT index (hex)	4c0f
Fieldbus format	Long, 1=1 s
Modbus format	EInt

### Undervoltage [259]

Delay time starts counting when the fault is gone. When the time delay has elapsed, the alarm will be reset if the function is active.

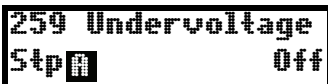
		
Default:		Off
Off	0	Off
1-3600	1-3600	1-3600 s

#### Communication information

Modbus Instance no/ DeviceNet no:	43088
Profibus slot/index	168/247

EtherCAT index (hex)	4c10
Fieldbus format	Long, 1=1 s
Modbus format	EInt

### Motor I<sup>2</sup>t [25A]

Delay time starts counting when the fault is gone. When the time delay has elapsed, the alarm will be reset if the function is active.

		<b>25A Motor I<sup>2</sup>t</b> <b>Stop Off</b>
Default:		Off
Off	0	Off
1–3600	1–3600	1–3600 s

#### Communication information

Modbus Instance no/ DeviceNet no:	43073
Profibus slot/index	168/232
EtherCAT index (hex)	4c01
Fieldbus format	Long, 1=1 s
Modbus format	EInt

### Motor I<sup>2</sup>t Trip Type [25B]

Select the preferred way to react to a Motor I<sup>2</sup>t trip.

		<b>25B Motor I<sup>2</sup>t TT</b> <b>Stop Trip</b>
Default:		Trip
Trip	0	The motor will trip
Deceleration	1	The motor will decelerate

#### Communication information

Modbus Instance no/ DeviceNet no:	43074
Profibus slot/index	168/233
EtherCAT index (hex)	4c02
Fieldbus format	UInt
Modbus format	UInt

### PT100 [25C]

Delay time starts counting when the fault is gone. When the time delay has elapsed, the alarm will be reset if the function is active.

		<b>25C PT100</b> <b>Stop Off</b>
Default:		Off
Off	0	Off
1–3600	1–3600	1–3600 s

## Communication information

Modbus Instance no/ DeviceNet no:	43078
Profibus slot/index	168/237
EtherCAT index (hex)	4c06
Fieldbus format	Long, 1=1 s
Modbus format	EInt

## PT100 Trip Type [25D]

Delay time starts counting when the fault is gone. When the time delay has elapsed, the alarm will be reset if the function is active.

	
Default:	Trip
Selection:	Same as menu [25B]

## Communication information

Modbus Instance no/ DeviceNet no:	43079
Profibus slot/index	168/238
EtherCAT index (hex)	4c07
Fieldbus format	Uint
Modbus format	UInt

## PTC [25E]

Delay time starts counting when the fault is gone. When the time delay has elapsed, the alarm will be reset if the function is active.

	
Default:	Off
Off	0
1-3600	1-3600
	1-3600 s

## Communication information

Modbus Instance no/ DeviceNet no:	43084
Profibus slot/index	168/243
EtherCAT index (hex)	4c0c
Fieldbus format	Long, 1=1 s
Modbus format	EInt

## PTC Trip Type [25F]

Select the preferred way to react to a PTC trip.

	
Default:	Trip
Selection:	Same as menu [25B]



## Communication information

Modbus Instance no/ DeviceNet no:	43085
Profibus slot/index	168/244
EtherCAT index (hex)	4c0d
Fieldbus format	UInt
Modbus format	UInt

## External Trip [25G]

Delay time starts counting when the fault is gone. When the time delay has elapsed, the alarm will be reset if the function is active.

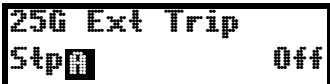
		
Default:	Off	
Off	0	Off
1-3600	1-3600	1-3600 s

## Communication information

Modbus Instance no/ DeviceNet no:	43080
Profibus slot/index	168/239
EtherCAT index (hex)	4c08
Fieldbus format	Long, 1=1 s
Modbus format	EInt

## External Trip Type [25H]

Select the preferred way to react to an alarm trip.

	
Default:	Trip
Selection:	Same as menu [25B]

## Communication information

Modbus Instance no/ DeviceNet no:	43081
Profibus slot/index	168/240
EtherCAT index (hex)	4c09
Fieldbus format	UInt
Modbus format	UInt

## Communication Error [25I]

Delay time starts counting when the fault is gone. When the time delay has elapsed, the alarm will be reset if the function is active.

	
Default:	Off

Off	0	Off
1–3600	1–3600	1–3600 s

## Communication information

Modbus Instance no/ DeviceNet no:	43089
Profibus slot/index	168/248
EtherCAT index (hex)	4c11
Fieldbus format	Long, 1=1 s
Modbus format	EInt

## Communication Error Trip Type [25J]

Select the preferred way to react to a communication trip.

	
Default:	Trip
Selection:	Same as menu [25B]

## Communication information

Modbus Instance no/ DeviceNet no:	43090
Profibus slot/index	168/249
EtherCAT index (hex)	4c12
Fieldbus format	UInt
Modbus format	UInt

## Min Alarm [25K]

Delay time starts counting when the fault is gone. When the time delay has elapsed, the alarm will be reset if the function is active.

		
Default:	Off	
Off	0	Off
1–3600	1–3600	1–3600 s

## Communication information

Modbus Instance no/ DeviceNet no:	43091
Profibus slot/index	168/250
EtherCAT index (hex)	4c13
Fieldbus format	Long, 1=1 s
Modbus format	EInt

### Min Alarm Trip Type [25L]

Select the preferred way to react to a min alarm trip.

<b>25L Min Alarm TT</b> Stop Trip	
Default:	Trip
Selection:	Same as menu [25B]

#### Communication information

Modbus Instance no/ DeviceNet no:	43092
Profibus slot/index	168/251
EtherCAT index (hex)	4c14
Fieldbus format	UInt
Modbus format	UInt

### Max Alarm [25M]

Delay time starts counting when the fault is gone. When the time delay has elapsed, the alarm will be reset if the function is active.

<b>25M Max Alarm</b> Stop Off		
Default:	Off	
Off	0	Off
1–3600	1– 3600	1–3600 s

#### Communication information

Modbus Instance no/ DeviceNet no:	43093
Profibus slot/index	168/252
EtherCAT index (hex)	4c15
Fieldbus format	Long, 1=1 s
Modbus format	EInt

### Max Alarm Trip Type [25N]

Select the preferred way to react to a max alarm trip.

<b>25N Max Alarm TT</b> Stop Trip	
Default:	Trip
Selection:	Same as menu [25B]

#### Communication information

Modbus Instance no/ DeviceNet no:	43094
Profibus slot/index	168/253
EtherCAT index (hex)	4c16
Fieldbus format	UInt
Modbus format	UInt

### Over current F [25O]

Delay time starts counting when the fault is gone. When the time delay has elapsed, the alarm will be reset if the function is active.

Default:	Off	
Off	0	Off
1-3600	1-3600	1-3600 s

#### Communication information

Modbus Instance no/ DeviceNet no:	43082
Profibus slot/index	168/241
EtherCAT index (hex)	4c0a
Fieldbus format	Long, 1=1 s
Modbus format	EInt

### Over Speed [25Q]

Delay time starts counting when the fault is gone. When the time delay has elapsed, the alarm will be reset if the function is active.

Default:	Off	
Off	0	Off
1-3600	1-3600	1-3600 s

#### Communication information

Modbus Instance no/ DeviceNet no:	43096
Profibus slot/index	169/0
EtherCAT index (hex)	4c18
Fieldbus format	Long, 1=1 s
Modbus format	EInt

### External Motor Temperature [25R]

Delay time starts counting when the fault disappears. When the time delay has elapsed, the alarm will be reset if the function is active.

Default:	Off	
Off	0	Off
1-3600	1-3600	1-3600 s

#### Communication information

Modbus Instance no/ DeviceNet no:	43097
Profibus slot/index	168/239

EtherCAT index (hex)	4c19
Fieldbus format	Long, 1=1 s
Modbus format	EInt

### External Motor Trip Type [25S]

Select the preferred way to react to an alarm trip.

	
Default:	Trip
Selection:	Same as menu [25B]

#### Communication information

Modbus Instance no/ DeviceNet no:	43098
Profibus slot/index	168/240
EtherCAT index (hex)	4c1a
Fieldbus format	UInt
Modbus format	UInt

### Liquid cooling low level [25T]

Delay time starts counting when the fault disappears. When the time delay has elapsed, the alarm will be reset if the function is active.

		
Default:	Off	
Off	0	Off
1-3600	1- 3600	1-3600 s

#### Communication information

Modbus Instance no/ DeviceNet no:	43099
Profibus slot/index	169/3
EtherCAT index (hex)	4c1b
Fieldbus format	Long, 1=1 s
Modbus format	EInt

### Liquid Cooling Low level Trip Type [25U]

Select the preferred way to react to an alarm trip.

	
Default:	Trip
Selection:	Same as menu [25B]

Communication information

Modbus Instance no/ DeviceNet no:	43100
Profibus slot/index	169/4
EtherCAT index (hex)	4c1c
Fieldbus format	UInt
Modbus format	UInt

Brake Fault [25V]

Select the preferred way to react to an alarm trip, activate auto reset and specify delay time.

Default		Off
Off	0	Autoreset not activated.
1 - 3600s	1 - 3600s	Brake fault auto reset delay time.

Communication information

Modbus Instance no/ DeviceNet no:	43070
Profibus slot/index	169/229
EtherCAT index (hex)	4bfe
Fieldbus format	Long, 1=1s
Modbus format	EInt

11-2-8 Serial Communication [260]

This function is to define the communication parameters for serial communication. There are two types of options available for serial communication, RS232/485 (Modbus/RTU) and fieldbus modules (Profibus, DeviceNet and Ethernet). For more information see chapter Serial communication and respective option manual.

Comm Type [261]

Select RS232/485 [262] or Fieldbus [263].

Default:		RS232/485
RS232/485	0	RS232/485 selected
Fieldbus	1	Fieldbus selected (Profibus, DeviceNet or Modbus/TCP)

**Note** Toggling the setting in this menu will perform a soft reset (re-boot) of the Fieldbus module.

### RS232/485 [262]

Press Enter to set up the parameters for RS232/485 (Modbus/RTU) communication.

<div style="border: 2px solid black; padding: 5px; display: inline-block;">                 262 RS232/485                  Stp             </div>
---

### Baud rate [2621]

Set the baud rate for the communication.

**Note** This baud rate is only used for the isolated RS232/485 option.

<div style="border: 2px solid black; padding: 5px; display: inline-block;">                 2621 Baudrate                  Stp 9600             </div>		
Default:	9600	
2400	0	Selected baud rate
4800	1	
9600	2	
19200	3	
38400	4	

### Address [2622]

Enter the unit address for the VSD.

**Note** This address is only used for the isolated RS232/485 option.

<div style="border: 2px solid black; padding: 5px; display: inline-block;">                 2622 Address                  Stp 1             </div>		
Default:	1	
Selection:	1-247	

### Fieldbus [263]

Press Enter to set up the parameters for fieldbus communication.

<div style="border: 2px solid black; padding: 5px; display: inline-block;">                 263 Fieldbus                  Stp             </div>
--

### Address [2631]

Enter/view the unit/node address of the VSD. Read & write access for Profibus, DeviceNet. Read only for EtherCAT.

<div style="border: 2px solid black; padding: 5px; display: inline-block;">                 2631 Address                  Stp 62             </div>		
Default:	62	
Range:	Profibus 0-126, DeviceNet 0-63	
Node address valid for Profibus (RW), DeviceNet (RW) and EtherCAT (RO).		

Process Data Mode [2632]

Enter the mode of process data (cyclic data). For further information, see the Fieldbus option manual.

<div style="border: 2px solid black; padding: 2px; display: inline-block;">                 2632 PrData Mode                  Stp <input type="checkbox"/> Basic             </div>		
Default:		Basic
None	0	Control/status information is not used.
Basic	4	4 byte process data control/status information is used.
Extended	8	4 byte process data (same as Basic setting) + additional proprietary protocol for advanced users is used.

Read/Write [2633]

Select read/write to control the inverter over a fieldbus network. For further information, see the Fieldbus option manual.

<div style="border: 2px solid black; padding: 2px; display: inline-block;">                 2633 Read/Write                  Stp <input type="checkbox"/> RW             </div>		
Default:		RW
RW	0	
Read	1	
Valid for process data. Select R (read only) for logging process without writing process data. Select RW in normal cases to control inverter.		

Additional Process Values [2634]

Define the number of additional process values sent in cyclic messages.

<div style="border: 2px solid black; padding: 2px; display: inline-block;">                 2634 AddPrValues                  Stp <input type="checkbox"/> 0             </div>		
Default:		0
Range:		0-8

Communication Fault [264]

Main menu for communication fault/warning settings. For further details please see the Fieldbus option manual.

Communication Fault Mode [2641]

Selects action if a communication fault is detected.

<div style="border: 2px solid black; padding: 2px; display: inline-block;">                 2641 ComFlt Mode                  Stp <input type="checkbox"/> Off             </div>		
Default:		Off
Off	0	No communication supervision.



Trip	1	<p>RS232/485 selected: The VSD will trip if there is no communication for time set in parameter [2642].</p> <p>Fieldbus selected: The VSD will trip if:</p> <ol style="list-style-type: none"> <li>1. The internal communication between the control board and fieldbus option is lost for time set in parameter [2642].</li> <li>2. If a serious network error has occurred.</li> </ol>
Warning	2	<p>RS232/485 selected: The VSD will give a warning if there is no communication for time set in parameter [2642].</p> <p>Fieldbus selected: The VSD will give a warning if:</p> <ol style="list-style-type: none"> <li>1. The internal communication between the control board and fieldbus option is lost for time set in parameter [2642].</li> <li>2. If a serious network error has occurred.</li> </ol>

**Note** Menu [214] and/or [215] must be set to COM to activate the communication fault function.

Communication information

Modbus Instance no/ DeviceNet no:	43037
Profibus slot/index	168/196
EtherCAT index (hex)	4bdd
Fieldbus format	UInt
Modbus format	UInt

Communication Fault Time [2642]]

Defines the delay time for the trip/warning.

	
Default:	0.5 s
Range:	0.1-15 s

Communication information

Modbus Instance no/ DeviceNet no:	43038
Profibus slot/index	168/197
EtherCAT index (hex)	4bde
Fieldbus format	Long, 1=0.1 s
Modbus format	EInt

### Ethernet [265]

Settings for Ethernet module (Modbus/TCP). For further information, see the Fieldbus option manual.

**Note** The Ethernet module must be re-booted to activate the below settings. For example by toggling parameter [261]. Non-initialized settings indicated by flashing display text.

#### IP Address [2651]

<div style="border: 2px solid black; padding: 5px; display: inline-block;">                 2651 IP Address                  0. 0. 0. 0             </div>	
Default:	0.0.0.0

#### MAC Address [2652]

<div style="border: 2px solid black; padding: 5px; display: inline-block;">                 2652 MAC Address                  Stp 000000000000             </div>	
Default:	An unique number for the Ethernet module.

#### Subnet Mask [2653]

<div style="border: 2px solid black; padding: 5px; display: inline-block;">                 2653 Subnet Mask                  0. 0. 0. 0             </div>	
Default:	0.0.0.0

#### Gateway [2654]

<div style="border: 2px solid black; padding: 5px; display: inline-block;">                 2654 Gateway                  0. 0. 0. 0             </div>	
Default:	0.0.0.0

#### DHCP [2655]

<div style="border: 2px solid black; padding: 5px; display: inline-block;">                 2655 DHCP                  Stp Off             </div>	
Default:	Off
Selection:	On/Off

### Fieldbus Signals [266]

Defines modbus mapping for additional process values. For further information, see the Fieldbus option manual.

#### FB Signal 1 - 16 [2661]-[266G]

Used to create a block of parameters which are read/written via communication. 1 to 8 read + 1 to 8 write parameters possible.

<div style="border: 2px solid black; padding: 5px; display: inline-block;">                 2661 FB Signal 1                  Stp 0             </div>	
Default:	0
Range:	0-65535

Communication information

Modbus Instance no/ DeviceNet no:	42801-42816
Profibus slot/index	167/215-167/230
EtherCAT index (hex)	4af1-4b00
Fieldbus format	UInt
Modbus format	UInt

FB Status [269]

Sub menus showing status of fieldbus parameters. Please see the Fieldbus manual for detailed information.

<table border="1"> <tr> <td>269 FB Status Stp</td> </tr> </table>	269 FB Status Stp
269 FB Status Stp	

### 11-3 Process and Application Parameters [300]

These parameters are mainly adjusted to obtain optimum process or machine performance.

The read-out, references and actual values depends on selected process source, [321]:

Table 24

Selected process source	Unit for reference and actual value	Resolution
Speed	rpm	4 digits
Torque	%	3 digits
PT100	°C	3 digits
Frequency	Hz	3 digits

#### 11-3-1 Set/View Reference Value [310]

View reference value

As default the menu [310] is in view operation. The value of the active reference signal is displayed. The value is displayed according to selected process source, [321] or the process unit selected in menu [322].

Set reference value

If the function Reference Control [214] is set to: Ref Control = Keyboard, the reference value can be set in menu Set/View Reference [310] as a normal parameter or as a motor potentiometer with the + and - keys on the control panel depending on the selection of Keyboard Reference Mode in menu [369]. The ramp times used for setting the reference value with the Normal function selected in menu [369] are according to the set Acc Time [331] and Dec Time [332]. The ramp times used for setting the reference value with the MotPot function selected in [369] are according to the set Acc MotPot [333] and Dec MotPot [334]. Menu [310] displays on-line the actual reference value according to the Mode Settings in Table 24.

<table border="1"> <tr> <td>310 Set/View ref Stp                      0rpm</td> </tr> </table>	310 Set/View ref Stp                      0rpm
310 Set/View ref Stp                      0rpm	
Default:	0 rpm
Dependent on:	Process Source [321] and Process Unit [322]
Speed mode	0 - max speed [343]

Torque mode	0 - max torque [351]
Other modes	Min according to menu [324] - max according to menu [325]

Communication information

Modbus Instance no/ DeviceNet no:	42991
Profibus slot/index	168/150
EtherCAT index (hex)	4baf
Fieldbus format	Long
Modbus format	EInt

**Note** The actual value in menu [310] is not copied, or loaded from the control panel memory when Copy Set [242], Copy to CP [244] or Load from CP [245] is performed.

**Note** If the MotPot function is used, the reference value ramp times are according to the Acc MotPot [333] and Dec MotPot [334] settings. Actual speed ramp will be limited according to Acc Time [331] and Dec Time [332].

**Note** Write access to this parameter is only allowed when menu "Ref Control [214] is set to Keyboard. When Reference control is used, see section 10.5 Reference signal.

### 11-3-2 Process Settings [320]

With these functions, the VSD can be set up to fit the application. The menus [110], [120], [310], [362]-[368] and [711] use the process unit selected in [321] and [322] for the application, e.g. rpm, bar or m<sup>3</sup>/h. This makes it possible to easily set up the VSD for the required process requirements, as well as for copying the range of a feedback sensor to set up the Process Value Minimum and Maximum in order to establish accurate actual process information.

#### Process Source [321]

Select the signal source for the process value that controls the motor. The Process Source can be set to act as a function of the process signal on AnIn F(AnIn), a function of the motor speed F(Speed), a function of the shaft torque F(Torque) or as a function of a process value from serial communication F(Bus). The right function to select depends on the characteristics and behaviour of the process. If the selection Speed, Torque or Frequency is set, the VSD will use speed, torque or frequency as reference value.

#### Example

An axial fan is speed-controlled and there is no feedback signal available. The process needs to be controlled within fixed process values in "m<sup>3</sup>/hr" and a process read-out of the air flow is needed. The characteristic of this fan is that the air flow is linearly related to the actual speed. So by selecting F(Speed) as the Process Source, the process can easily be controlled.

The selection F(xx) indicates that a process unit and scaling is needed, set in menus [322]-[328]. This makes it possible to e.g. use pressure sensors to measure flow etc. If F(AnIn) is selected, the source is automatically connected to the AnIn which has Process Value as selected.

		
Default:		Speed
F(AnIn)	0	Function of analogue input. E.g. via PID control, [330].
Speed	1	Speed as process reference <sup>1</sup> .

Torque	2	Torque as process reference <sup>2</sup> .
PT100	3	Temperature as process reference.
F(Speed)	4	Function of speed
F(Torque)	5	Function of torque <sup>2</sup>
F(Bus)	6	Function of communication reference
Frequency	7	Frequency as process reference <sup>1</sup> .

<sup>1</sup>. Only when Drive mode [213] is set to Speed or V/Hz.

<sup>2</sup>. Only when Drive mode [213] is set to Torque.

**Note** When PT100 is selected, use PT100 channel 1 on the PTC/PT100 option board.

**Note** If Speed, Torque or Frequency is chosen in menu [321] Proc Source, menus [322] - [328] are hidden.

**Note** The motor control method depends on the selection of drive mode [213], regardless of selected process source, [321].

**Note** If F (Bus) is chosen in menu [321]see section 10.5.1 Process value.

Communication information

Modbus Instance no/ DeviceNet no:	43302
Profibus slot/index	169/206
EtherCAT index (hex)	4ce6
Fieldbus format	UInt
Modbus format	UInt

Process Unit [322]

		
Default:		rpm
Off	0	No unit selection
%	1	Percent
°C	2	Degrees Centigrade
°F	3	Degrees Fahrenheit
bar	4	bar
Pa	5	Pascal
Nm	6	Torque
Hz	7	Frequency
rpm	8	Revolutions per minute
m <sup>3</sup> /h	9	Cubic meters per hour
gal/h	10	Gallons per hour
ft <sup>3</sup> /h	11	Cubic feet per hour
User	12	User defined unit

Communication information

Modbus Instance no/ DeviceNet no:	43303
Profibus slot/index	169/207
EtherCAT index (hex)	4ce7
Fieldbus format	UInt
Modbus format	UInt

**Note** In case of conflicting setup between this Process Source, [321], selection and drive mode [213] the software will automatically overrule the selection in menu [321] according to the following:  
 [213]=Torque and [321]=Speed; internally [321]=Torque will be used.  
 [213]=Speed or V/Hz and [321]=Torque; internally [321]=Speed will be used.

### User-defined Unit [323]

This menu is only displayed if User is selected in menu [322]. The function enables the user to define a unit with six symbols. Use the Prev and Next key to move the cursor to required position. Then use the + and - keys to scroll down the character list. Confirm the character by moving the cursor to the next position by pressing the Next key.

Character	No. for serial comm.	Character	No. for serial comm.
Space	0	m	58
0-9	1-10	n	59
A	11	ñ	60
B	12	o	61
C	13	ó	62
D	14	ô	63
E	15	p	64
F	16	q	65
G	17	r	66
H	18	s	67
I	19	t	68
J	20	u	69
K	21	ü	70
L	22	v	71
M	23	w	72
N	24	x	73
O	25	y	74
P	26	z	75
Q	27	â	76
R	28	ä	77
S	29	ö	78
T	30	!	79
U	31	“	80
Ü	32	#	81
V	33	\$	82
W	34	%	83
X	35	&	84
Y	36	.	85
Z	37	(	86
Å	38	)	87
Ä	39	*	88
Ö	40	+	89
a	41	,	90
á	42	-	91
b	43	.	92
c	44	/	93
d	45	:	94
e	46	;	95

Character	No. for serial comm.	Character	No. for serial comm.
é	47	<	96
ê	48	=	97
ë	49	>	98
f	50	?	99
g	51	@	100
h	52	^	101
i	53	_	102
í	54	°	103
j	55	²	104
k	56	³	105
l	57		

**Example:**

Create a user unit named kPa.

1. When in the menu [323] press the + key to show the cursor.
2. Press the NEXT key to move the cursor to the right most position.
3. Press the + key until the character a is displayed.
4. Press the PREVIOUS key.
5. Then press the + key until P is displayed and press the PREVIOUS key.
6. Repeat until you have entered kPa, confirm with the ENTER key.

	
Default:	No characters shown

**Communication information**

Modbus Instance no/ DeviceNet no:	43304-43309
Profibus slot/index	169/208-169/213
EtherCAT index (hex)	4ce8-4ced
Fieldbus format	UInt
Modbus format	UInt

When sending a unit name you send one character at a time starting at the right most position.

**Process Min [324]**

This function sets the minimum process value allowed.

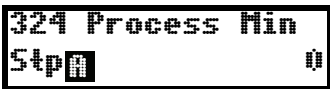
	
Default:	0
Range:	0.000-10000 (Speed, Torque, F(Speed), F(Torque)) -10000– +10000 (F(AnIn, PT100, F(Bus))

**Communication information**

Modbus Instance no/ DeviceNet no:	43310
Profibus slot/index	169/214
EtherCAT index (hex)	4cee

Fieldbus format	Long, 1=0.001
Modbus format	EInt

### Process Max [325]

This menu is not visible when speed, torque or frequency is selected. The function sets the value of the maximum process value allowed.

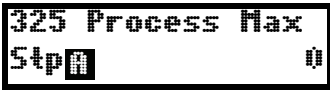
	
Default:	0
Range:	0.000-10000

#### Communication information

Modbus Instance no/ DeviceNet no:	43311
Profibus slot/index	169/215
EtherCAT index (hex)	4cef
Fieldbus format	Long, 1=0.001
Modbus format	EInt

### Ratio [326]

This menu is not visible when speed, frequency or torque is selected. The function sets the ratio between the actual process value and the motor speed so that it has an accurate process value when no feedback signal is used. See Fig. 66.

	
Default:	Linear
Linear	0 Process is linear related to speed/torque
Quadratic	1 Process is quadratic related to speed/torque

#### Communication information

Modbus Instance no/ DeviceNet no:	43312
Profibus slot/index	169/216
EtherCAT index (hex)	4cf0
Fieldbus format	UInt
Modbus format	UInt



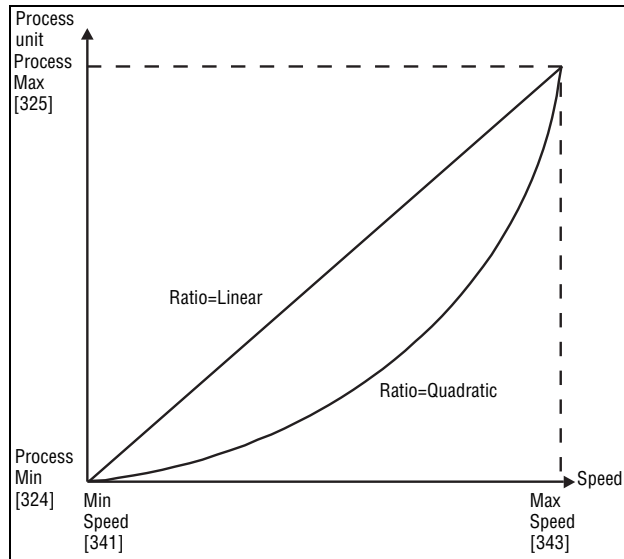

Fig. 66 Ratio

### F(Value), Process Min [327]

This function is used for scaling if no sensor is used. It offers you the possibility of increasing the process accuracy by scaling the process values. The process values are scaled by linking them to known data in the VSD. With F(Value), Proc Min [327] the precise value at which the entered Process Min [324] is valid can be entered.

**Note** If Speed, Torque or Frequency is chosen in menu [321] Proc Source, menus [322]- [328] are hidden.

<div style="border: 2px solid black; padding: 2px; display: inline-block;">                 327 F(Val) PrMin                  Stop Min             </div>		
Default:		Min
Min	-1	According to Min Speed setting in [341].
Max	-2	According to Max Speed setting in [343].
0.000-10000	0-1000 0	0.000-10000

#### Communication information

Modbus Instance no/ DeviceNet no:	43313
Profibus slot/index	169/217
EtherCAT index (hex)	4cf1
Fieldbus format	Long, 1=1 rpm
Modbus format	EInt

### F(Value), Process Max [328]

This function is used for scaling if no sensor is used. It offers you the possibility of increasing the process accuracy by scaling the process values. The process values are scaled by linking them to known data in the VSD. With F(Value), Proc Max the precise value at which the entered Process Max [525] is valid can be entered.

**Note** If Speed, Torque or Frequency is chosen in menu [321] Proc Source, menus [322]- [328] are hidden.

		328 F(Val) PrMax Stop Max
Default:		Max
Min	-1	Min
Max	-2	Max
0.000-10000	0-1000 0	0.000-10000

Communication information

Modbus Instance no/ DeviceNet no:	43314
Profibus slot/index	169/218
EtherCAT index (hex)	4cf2
Fieldbus format	Long, 1=1 rpm
Modbus format	EInt

Example

A conveyor belt is used to transport bottles. The required bottle speed needs to be within 10 to 100 bottles/s. Process characteristics:

10 bottles/s = 150 rpm

100 bottles/s = 1500 rpm

The amount of bottles is linearly related to the speed of the conveyor belt.

Set-up:

Process Min [324] = 10

Process Max [325] = 100

Ratio [326] = linear

F(Value), ProcMin [327] = 150

F(Value), ProcMax [328] = 1500

With this set-up, the process data is scaled and linked to known values which results in an accurate control.

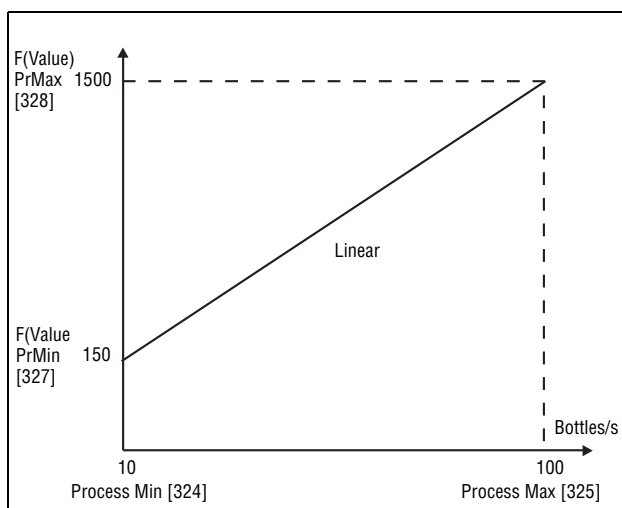

Fig. 67

### 11-3-3 Start/Stop settings [330]

Submenu with all the functions for acceleration, deceleration, starting, stopping, etc.

#### Acceleration Time [331]

The acceleration time is defined as the time it takes for the motor to accelerate from 0 rpm to nominal motor speed.

**Note** If the Acc Time is too short, the motor is accelerated according to the Torque Limit. The actual Acceleration Time may then be longer than the value set.

<div style="border: 2px solid black; padding: 5px; display: inline-block;"> <b>331 Acc Time</b>                  Stop <input type="text" value="10.0s"/> </div>	
Default:	10.0 s
Range:	0–3600 s

#### Communication information

Modbus Instance no/ DeviceNet no:	43101
Profibus slot/index	169/5
EtherCAT index (hex)	4c1d
Fieldbus format	Long, 1=0.01 s
Modbus format	EInt

Fig. 68 shows the relationship between nominal motor speed/max speed and the acceleration time. The same is valid for the deceleration time.

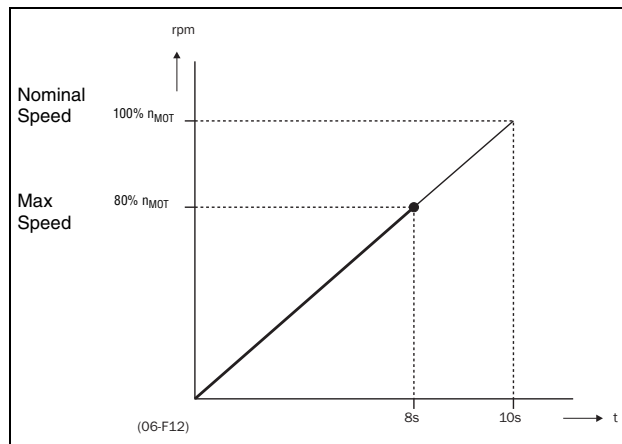

Fig. 68 Acceleration time and maximum speed

Fig. 69 shows the settings of the acceleration and deceleration times with respect to the nominal motor speed.

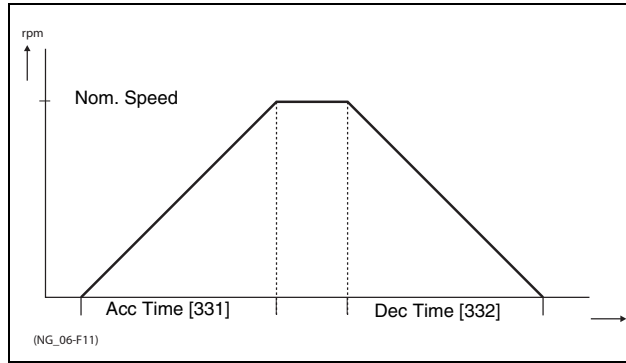

Fig. 69 Acceleration and deceleration times

### Deceleration Time [332]

The deceleration time is defined as the time it takes for the motor to decelerate from nominal motor speed to 0 rpm.

	<b>332 Dec Time</b> Stop 10.0s
Default:	10.0 s
Range:	0–3600 s

#### Communication information

Modbus Instance no/ DeviceNet no:	43102
Profibus slot/index	169/6
EtherCAT index (hex)	4c1e
Fieldbus format	Long, 1=0.01 s
Modbus format	EInt

**Note** If the Dec Time is too short and the generator energy cannot be dissipated in a brake resistor, the motor is decelerated according to the overvoltage limit. The actual deceleration time may be longer than the value set.

### Acceleration Time Motor Potentiometer [333]

It is possible to control the speed of the VSD using the motor potentiometer function. This function controls the speed with separate up and down commands, over remote signals. The MotPot function has separate ramps settings which can be set in Acc MotPot [333] and Dec MotPot [334].

If the MotPot function is selected, this is the acceleration time for the MotPot up command. The acceleration time is defined as the time it takes for the motor potentiometer value to increase from 0 rpm to nominal speed.

	<b>333 Acc MotPot</b> Stop 16.0s
Default:	16.0 s
Range:	0.50–3600 s

#### Communication information

Modbus Instance no/ DeviceNet no:	43103
Profibus slot/index	169/7
EtherCAT index (hex)	4c1f

Fieldbus format	Long, 1=0.01 s
Modbus format	EInt

### Deceleration Time Motor Potentiometer [334]

If the MotPot function is selected, this is the deceleration time for the MotPot down command. The deceleration time is defined as the time it takes for the motor potentiometer value to decrease from nominal speed to 0 rpm.

	
Default:	16.0 s
Range:	0.50–3600 s

#### Communication information

Modbus Instance no/ DeviceNet no:	43104
Profibus slot/index	169/8
EtherCAT index (hex)	4c20
Fieldbus format	Long, 1=0.01
Modbus format	EInt

### Acceleration Time to Minimum Speed [335]

If minimum speed, [341]>0 rpm, is used in an application, the VSD uses separate ramp times below this level. With Acc>MinSpeed [335] and Dec<MinSpeed [336] you can set the required ramp times. Short times can be used to prevent damage and excessive pump wear due too little lubrication at lower speeds. Longer times can be used to fill up a system smoothly and prevent water hammer due to rapidly exhausting air from the pipe system.

If a Minimum speed is programmed, this parameter will be used to select the acceleration time parameter [335] for speeds up to minimum speed at a run command. The ramp time is defined as the time it takes for the motor to accelerate from 0 rpm to nominal motor speed.

	
Default:	10.0 s
Range:	0-3600 s

#### Communication information

Modbus Instance no/ DeviceNet no:	43105
Profibus slot/index	169/9
EtherCAT index (hex)	4c21
Fieldbus format	Long, 1=0.01
Modbus format	EInt

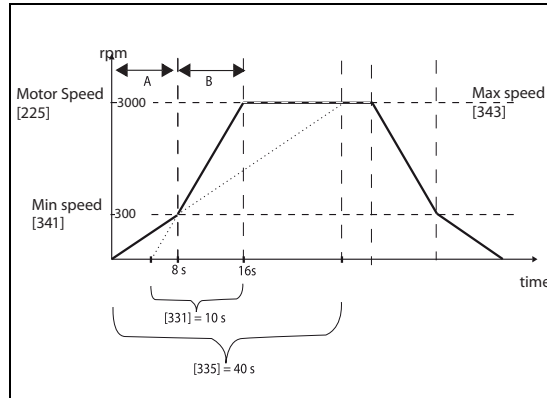

Fig. 70 Calculation example of accelerating times (graphics not proportional)

**Example**

- Motor speed [225]: 3000 rpm
- Minimum speed [341]: 600 rpm
- Maximum speed [343]: 3000 rpm
- Acceleration time [331]: 10 seconds
- Deceleration time [332]: 10 seconds
- Acc>Min speed [335]: 40 seconds
- Dec<Min speed [336]: 40 seconds

- A. The drive will start from 0 rpm and accelerate to Minimum speed [341] = 600 rpm in 8 seconds according to ramp time parameter Acc>Min speed [335]. Calculated as following:  
 600 rpm is 20% of 3000 rpm => 20% of 40 s = 8 s.
- B. The acceleration continues from minimum speed level 600 rpm to maximum speed level 3000 rpm with acceleration rate according to ramp time Acceleration time [331]. Calculate by following:  
 3000 - 600 = 2400 rpm which is 80 % of 3000 rpm => acceleration time is 80% x 10 s = 8 s.  
 This means that the total acceleration time from 0 - 3000 rpm will take 8 + 8 = 16 seconds.

**Deceleration Time from Minimum Speed [336]**

If a minimum speed is programmed, this parameter will be used to set the deceleration time from the minimum speed to 0 rpm at a stop command. The ramp time is defined as the time it takes for the motor to decelerate from the nominal motor speed to 0 rpm.

<div style="border: 2px solid black; padding: 2px; display: inline-block;">                 336 Dec&lt;Min Spd                  Stop 10.0s             </div>	
Default:	10.0 s
Range:	0-3600 s

Communication information

Modbus Instance no/ DeviceNet no:	43106
Profibus slot/index	169/10
EtherCAT index (hex)	4c22

Fieldbus format	Long, 1=0.01 s
Modbus format	EInt

### Acceleration Ramp Type [337]

Sets the type of all the acceleration ramps in a parameter set. See Fig. 71. Depending on the acceleration and deceleration requirements for the application, the shape of both the ramps can be selected. For applications where speed changes need to be started and stopped smoothly, such as a conveyor belt with materials that can drop following a quick speed change, the ramp shape can be adapted to a S-shape and prevent speed change shocks. For applications that are not critical in this, the speed change can be fully linear over the complete range.

<b>337 Acc Rmp</b>		<b>Linear</b>
<b>Stop</b>		
Default:		Linear
Linear	0	Linear acceleration ramp.
S-Curve	1	S-shape acceleration ramp.

**Note** For S-curve ramps the ramp times, [331] and [332], defines the maximum acceleration and deceleration rated, i.e. linear part of S-curve, just as for the linear ramps. The S-curves are implemented so that for a speed step below sync speed the ramps are fully S-shaped while for larger steps the middle part will be linear. Therefore will a S-curve ramp from 0 –sync speed take 2 x Time while a step from 0–2 x sync speed will take 3 x Time (middle part 0.5 sync speed – 1.5 sync speed linear). Also valid for menu [337], Deceleration ramp type.

#### Communication information

Modbus Instance no/ DeviceNet no:	43107
Profibus slot/index	169/11
EtherCAT index (hex)	4c23
Fieldbus format	UInt
Modbus format	UInt

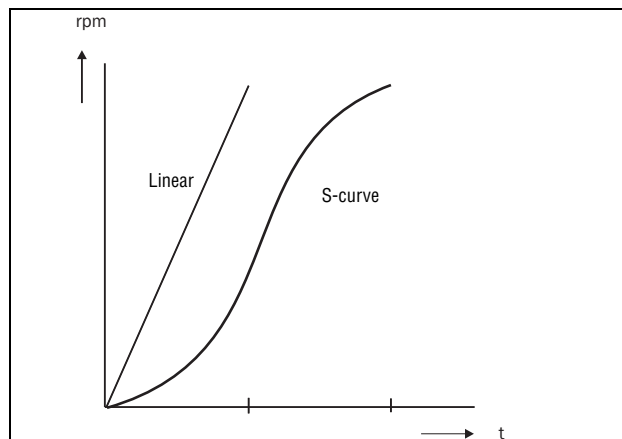

Fig. 71 Shape of acceleration ramp

### Deceleration Ramp Type [338]

Sets the ramp type of all deceleration parameters in a parameter set Fig. 72.

<b>338 Dec Rmp</b> Stop <input checked="" type="checkbox"/> Linear	
Default:	Linear
Selection:	Same as menu [337]

Communication information

Modbus Instance no/ DeviceNet no:	43108
Profibus slot/index	169/12
EtherCAT index (hex)	4c24
Fieldbus format	UInt
Modbus format	UInt

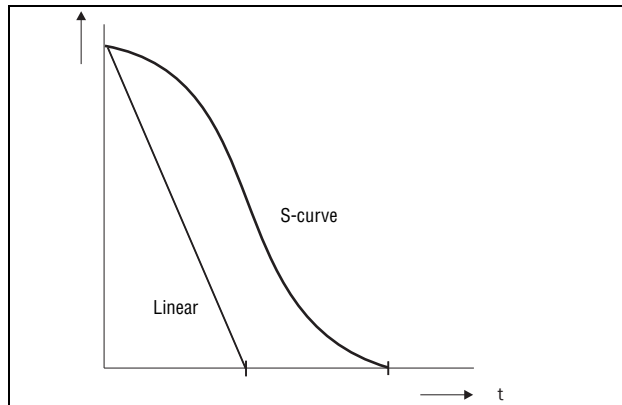

Fig. 72 Shape of deceleration ramp

### Start Mode [339]

Sets the way of starting the motor when a run command is given.

<b>339 Start Mode</b> Stop <input checked="" type="checkbox"/> Normal DC		
Default:	Normal DC	
Fast	0	The motor shaft flux increases gradually. The motor shaft starts rotating immediately once the Run command is given.
Normal DC	1	After a Run command the motor will be magnetised first and the stator resistance is measured. Depending on the motor time constant and the size of the motor it can take up to 1.3 s before the motor shaft starts to rotate. This will provide better control of the motor when starting.

Communication information

Modbus Instance no/ DeviceNet no:	43109
Profibus slot/index	169/13
EtherCAT index (hex)	4c25
Fieldbus format	UInt
Modbus format	UInt



### Spinstart [33A]

The spinstart will smoothly start a motor which is already rotating by catching the motor at the actual speed and control it to the desired speed. If in an application, such as an exhausting fan, the motor shaft is already rotating due to external conditions, a smooth start of the application is required to prevent excessive wear. With the spinstart=on, the actual control of the motor is delayed due to detecting the actual speed and rotation direction, which depend on motor size, running conditions of the motor before the Spinstart, inertia of the application, etc. Depending on the motor electrical time constant and the size of the motor, it can take maximum a couple of minutes before the motor is caught.

		<b>33A Spinstart</b> Stp <input type="checkbox"/> Off
Default:		Off
Off	0	No spinstart. If the motor is already running the VSD can trip or will start with high current.
On	1	Spinstart will allow the start of a running motor without tripping or high inrush currents. If encoder feedback is used, both encoder speed and current signals are used to perform spinstart function.
Use encoder	2	Only encoder speed used for detecting rotating machine, i.e. no rotating machine detection via initial motor current. <b>Note:</b> Only active if encoder is present. If no encoder, functionality is equal to selection Off.

#### Communication information

Modbus Instance no/ DeviceNet no:	43110
Profibus slot/index	169/14
EtherCAT index (hex)	4c26
Fieldbus format	UInt
Modbus format	UInt

### Stop Mode [33B]

When the VSD is stopped, different methods to come to a standstill can be selected in order to optimize the stop and prevent unnecessary wear. Stop Mode sets the way of stopping the motor when a Stop command is given.

		<b>33B Stop Mode</b> Stp <input type="checkbox"/> Decel
Default:		Decel
Decel	0	The motor decelerates to 0 rpm according to the set deceleration time.
Coast	1	The motor freewheels naturally to 0 rpm.

#### Communication information

Modbus Instance no/ DeviceNet no:	43111
Profibus slot/index	169/15
EtherCAT index (hex)	4c27
Fieldbus format	UInt
Modbus format	UInt

### 11-3-4 Mechanical brake control

The four brake-related menus [33C] to [33F] can be used to control mechanical brakes e.g. to handle basic hoisting functions. When hoisting a load generally a mechanical brake holds the load when the VSD is not running. To prevent the load from falling down a holding torque must be initiated before the mechanical brake is released. On the other hand when stopping hoisting the brake must be activated before the holding torque is removed.

Support is included for a Brake Acknowledge signal via a digital input. It is monitored using a brake fault time parameter. Additional output and trip/warning signals are also included. The acknowledge signal is either connected from the brake contactor or from a proximity switch on the brake.

The brake acknowledge signal can also be used to improve safety by preventing hoist falling load in case the brake is not engaged when stopping.

#### Brake not released - Brake Fault trip.

During start and running the brake acknowledge signal is compared to the actual brake output signal and if no acknowledge, i.e. brake not realised, while brake output is high for the Brake Fault time [33H], then a Brake trip is generated.

#### Brake not engaged - Brake Warning and contiued operation (Keep torque)

The brake acknowledge signal is compared to the actual brake output signal at stop. If acknowledge is still active, i.e. brake not engaged, while brake output is low for the Brake Engage time [33E] then a Brake warning is generated and the torque is kept, i.e. prolonging normal brake engage mode, until brake closes or an emergency action is needed by the operator, such as setting down the load.

#### Brake Release Time [33C]

The Brake Release Time sets the time the VSD delays before ramping up to whatever final reference value is selected. During this time a predefined speed can be generated to hold the load where after the mechanical brake finally releases. This speed can be selected at Release Speed, [33D]. Immediate after the brake release time expiration the brake lift signal is set. The user can set a digital output or relay to the function Brake. This output or relay can control the mechanical brake.

	
Default:	0.00 s
Range:	0.00–3.00 s

#### Communication information

Modbus Instance no/ DeviceNet no:	43112
Profibus slot/index	169/16
EtherCAT index (hex)	4c28
Fieldbus format	Long, 1=0.01 s
Modbus format	EInt

Fig. 73 shows the relation between the Brake functions.

- Brake Release Time [33C]
- Start Speed [33D]

- Brake Engage Time [33E]
- Brake Wait Time [33F]

The correct time setting depends on the maximum load and the properties of the mechanical brake. During the brake release time it is possible to apply extra holding torque by setting a start speed reference with the function start speed [33D].

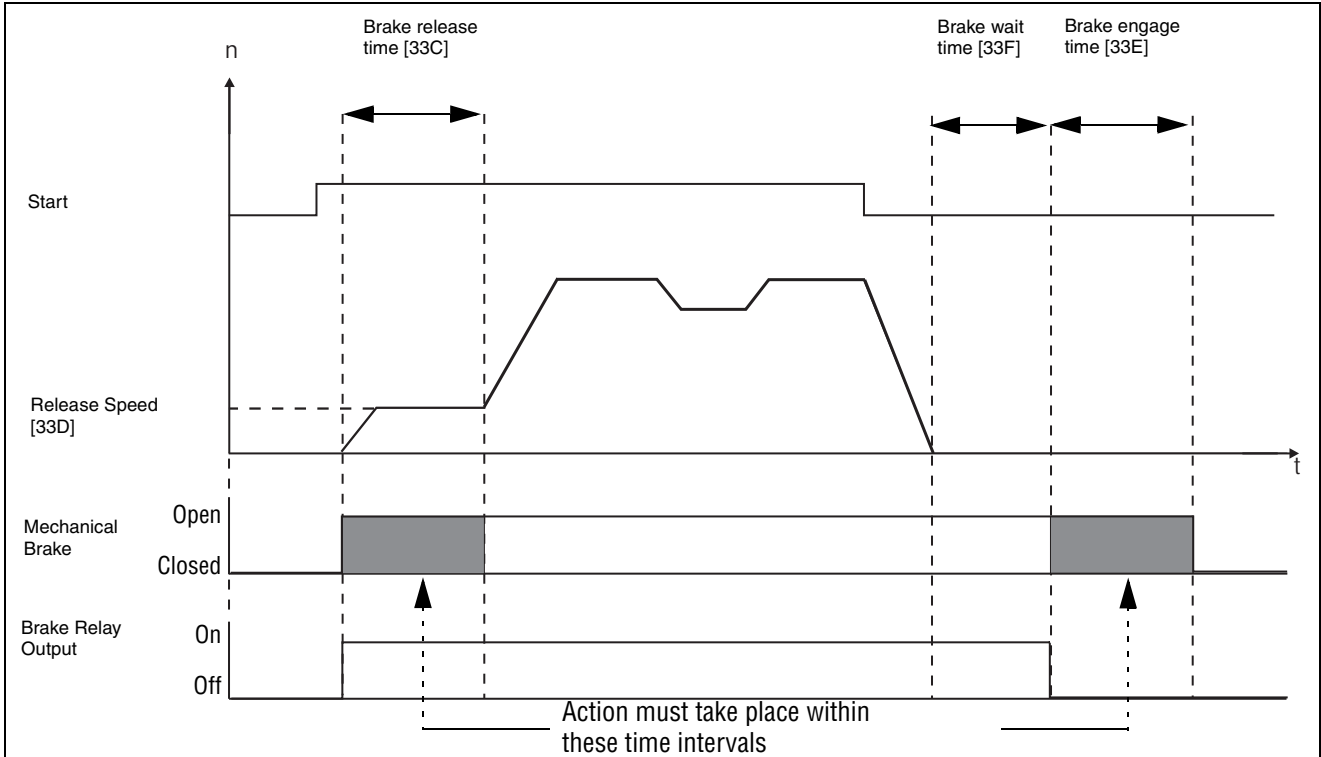

Fig. 73 Brake Output functions

**Note** Although this function is designed to operate a mechanical brake via the digital outputs or relays (set to brake function) controlling a mechanical brake, it can also be used without a mechanical brake and hold the load in a fixed position.

### Release Speed [33D]

The release speed only operates with the brake function: brake release [33C]. The release speed is the initial speed reference during the brake release time. The torque reference is initialized to 90% of  $T_{NOM}$  to ensure that the load is held in place.

	<b>33D Release Spd</b> 5rpm 0rpm
Default:	0 rpm
Range:	- 4x Sync. Speed to 4x Sync.
Depend on:	4xmotor sync speed, 1500 rpm for 1470 rpm motor.

#### Communication information

Modbus Instance no/ DeviceNet no:	43113
Profibus slot/index	169/17
EtherCAT index (hex)	4c29

Fieldbus format	Int, 1=1 rpm
Modbus format	Int, 1=1 rpm

### Brake Engage Time [33E]

The brake engage time is the time the load is held while the mechanical brake engages. It is also used to get a firm stop when transmissions, etc. cause “whiplash” effects. In other words, it compensates for the time it takes to engage a mechanical brake.

	
Default:	0.00 s
Range:	0.00–3.00 s

#### Communication information

Modbus Instance no/ DeviceNet no:	43114
Profibus slot/index	169/18
EtherCAT index (hex)	4c2a
Fieldbus format	Long, 1=0.01 s
Modbus format	EInt

### Wait Before Brake Time [33F]

The brake wait time is the time to keep brake open and to hold the load, either in order to be able to speed up immediately, or to stop and engage the brake.

	
Default:	0.00 s
Range:	0.00–30.0 s

#### Communication information

Modbus Instance no/ DeviceNet no:	43115
Profibus slot/index	169/19
EtherCAT index (hex)	4c2b
Fieldbus format	Long, 1=0.01 s
Modbus format	EInt

### Vector Brake [33G]

Braking by increasing the internal electrical losses in the motor.

		
Default:	Off	
Off	0	Vector brake switched off. VSD brakes normal with voltage limit on the DC link.
On	1	Maximum VSD current ( $I_{CL}$ ) is available for braking.

#### Communication information

Modbus Instance no/ DeviceNet no:	43116
Profibus slot/index	169/20

EtherCAT index (hex)	4c2c
Fieldbus format	UInt
Modbus format	UInt

### Brake Fault trip time [33H]

	
Default:	1.00s
Range	0.00 - 5.00s

#### Communication information

Modbus Instance no/ DeviceNet no:	43117
Profibus slot/index	169/21
EtherCAT index (hex)	4c2d
Fieldbus format	Long, 1=0.1s
Modbus format	EInt

**Note** The Brake Fault trip time should be set to longer time than the Brake release time[33C].

The “Brake not engaged” warning is using the setting of parameter “Brake Engaged time [33E]”.

Following Figure shows principle of brake operation for fault during run (left) and during stop (right)

### Release torque [33I]

The brake release time [33C] sets the time the VSD delays before ramping up to whatever final speed reference value is selected, to allow the brake to be fully opened. During this time a holding torque to prevent roll-back of the load can be activated. The parameter release torque [33I] is used for this purpose.

The release torque initiates the torque reference from the speed controller during the Brake Release Time [33C]. The release torque defines a minimum torque of release (holding) torque. The set release torque is internally overruled if the actual required holding torque measured at the previous closing of brake is higher.

The release torque is set with sign in order to define the holding torque direction.

	
Default:	0%
Range	-400% to 400%

#### Communication information

Modbus Instance no/ DeviceNet no:	43118
Profibus slot/index	169/22
EtherCAT index (hex)	4c2e
Fieldbus format	Long, 1=1H%
Modbus format	EInt

**Note** Function is deactivated if set to 0%.

**Note** Release torque [33I] has priority over torque reference initialization by Release Speed [33D].

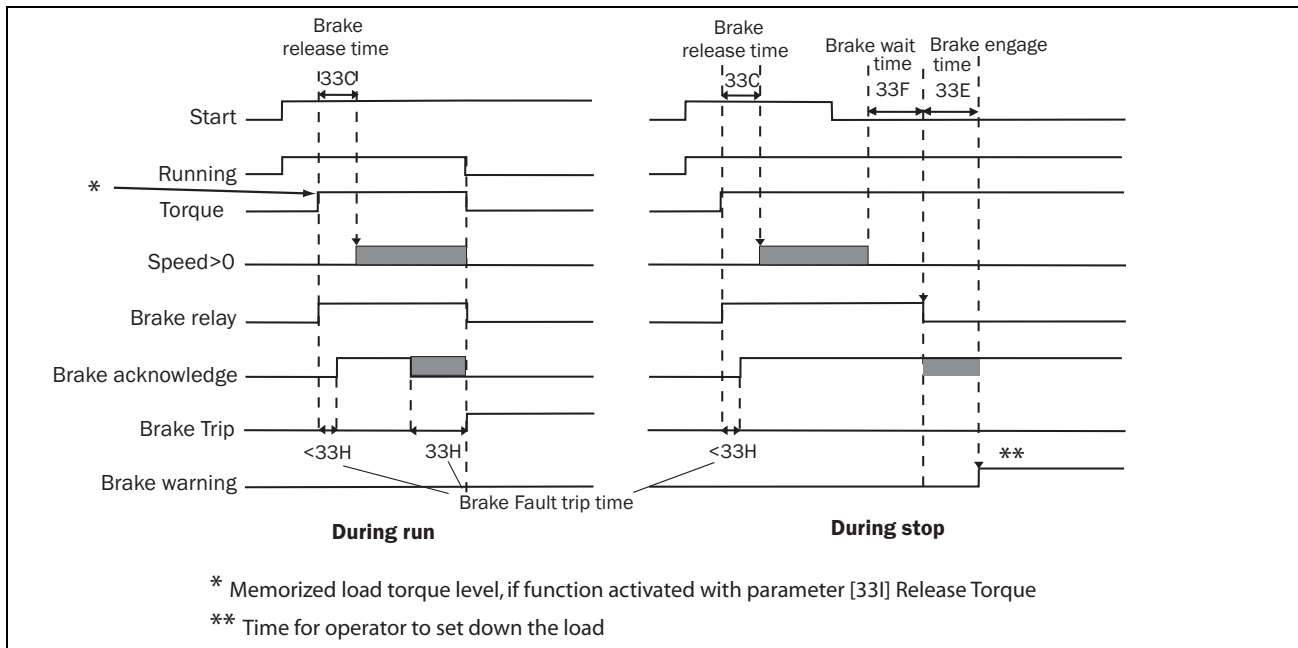

Fig. 74 Principle of brake operation for fault during run and during stop

### 11-3-5 Speed [340]

Menu with all parameters for settings regarding to speeds, such as Min/Max speeds, Jog speeds, Skip speeds.

#### Minimum Speed [341]

Sets the minimum speed. The minimum speed will operate as an absolute lower limit. Used to ensure the motor does not run below a certain speed and to maintain a certain performance.

	<div style="border: 1px solid black; padding: 2px; display: inline-block;">                 341 Min Speed                  Stop 0rpm             </div>
Default:	0 rpm
Range:	0 - Max Speed
Dependent on:	Set/View ref [310]

**Note** A lower speed value than the set minimum speed can be shown in the display due to motor slip.

#### Communication information

Modbus Instance no/ DeviceNet no:	43121
Profibus slot/index	169/25
EtherCAT index (hex)	4c31
Fieldbus format	Int, 1=1 rpm
Modbus format	Int, 1=1 rpm

### Stop/Sleep when less than Minimum Speed [342]

With this function it is possible to put the VSD in “sleep mode” when it is running at minimum speed for the length of time set in menu “Stp<MinSpd [342]”. The VSD will go into sleep mode after programmed time.

When the reference signal or PID Process controller output value (if PID Process controller is used) raises the required speed value above the min speed value, the VSD will automatically wake up and ramp up to the required speed.

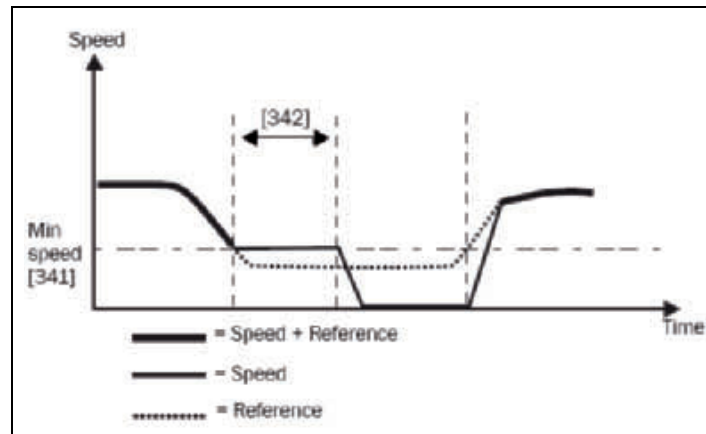

Fig. 75

If you want to use this function when having “process reference” signal via an analogue input, you need to make sure that the concerning analogue input is set up correct, meaning that AnIn Advanced parameter “AnIn1 FcMin [5134]” should be set from “Min” (=default) to “User defined” and “AnIn1 VaMin [5135]” set to a value less than “Min Speed [341]” to make it possible that the analogue input reference can go below the “Min Speed” level to activate the “Sleep mode”. This applies when PID Process controller is not used.

**Note** If [381] PID Process controller is used, then the PID sleep functionality [386]-[389] is recommended instead of [342].

**Note** Menu [386] has higher priority than menu [342].

		<div style="border: 1px solid black; padding: 2px;"> <p>342 Stp&lt;MinSpd</p> <p>Stp On Off</p> </div>
Default:		Off
Off	0	Off
1–3600	1–3600	1–3600 s

#### Communication information

Modbus Instance no/ DeviceNet no:	43122
Profibus slot/index	169/26
EtherCAT index (hex)	4c32
Fieldbus format	Long, 1=0.01 s
Modbus format	EInt

### Maximum Speed [343]

Sets the maximum speed at 10 V/20 mA, unless a user- defined characteristic of the analogue input is programmed. The synchronous speed (Sync-spd) is

determined by the parameter motor speed [225]. The maximum speed will operate as an absolute maximum limit.

This parameter is used to prevent damage due to high speed.

		<b>343 Max Speed</b> <b>Stp Sync speed</b>
Default:		Sync Speed
Sync Speed	0	Synchronous speed, i.e. no load speed, at nominal frequency.
1-2400rpm	1-2400 0	Min Speed - 4 x Motor Sync Speed

Communication information

Modbus Instance no/ DeviceNet no:	43123
Profibus slot/index	169/27
EtherCAT index (hex)	4c33
Fieldbus format	Int, 1=1 rpm
Modbus format	UInt

**Note** It is not possible to set the maximum speed lower than the minimum speed.

**Note** Maximum Speed [343] has priority over Min Speed [341], i.e. if [343] is set below [341] then the drive will run at [343] Max Speed with acceleration times given by [335] and [336] respectively.

### Skip Speed 1 Low [344]

Within the Skip Speed range High to Low, the speed cannot be constant in order to avoid mechanical resonance in the VSD system.

When Skip Speed Low ≤ Ref Speed ≤ Skip Speed High, then Output Speed=Skip Speed HI during deceleration and Output Speed=Skip Speed LO during acceleration. Fig. 76 shows the function of skip speed hi and low.

Between Skip Speed HI and LO, the speed changes with the set acceleration and deceleration times. Skipspd1 LO sets the lower value for the 1st skip range.

		<b>344 SkipSpd 1 Lo</b> <b>Stp 0rpm</b>
Default:		0 rpm
Range:		0 - 4 x Motor Sync Speed

Communication information

Modbus Instance no/ DeviceNet no:	43124
Profibus slot/index	169/28
EtherCAT index (hex)	4c34
Fieldbus format	Int
Modbus format	Int



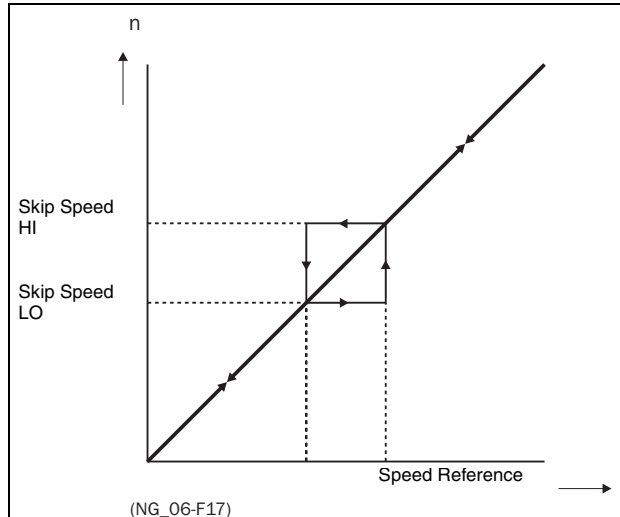

Fig. 76 Skip Speed

**Note** The two Skip Speed ranges may be overlapped.

### Skip Speed 1 High [345]

Skipspd1 HI sets the higher value for the 1st skip range.

<div style="border: 2px solid black; padding: 2px; display: inline-block;">                 345 SkipSpd 1 Hi                  Stp <span style="border: 1px solid black; padding: 0 5px;">  </span> 0rpm             </div>	
Default:	0 rpm
Range:	0 – 4 x Sync Speed

Communication information

Modbus Instance no/ DeviceNet no:	43125
Profibus slot/index	169/29
EtherCAT index (hex)	4c35
Fieldbus format	Int
Modbus format	Int

### Skip Speed 2 Low [346]

The same function as menu [344] for the 2nd skip range.

<div style="border: 2px solid black; padding: 2px; display: inline-block;">                 346 SkipSpd 2 Lo                  Stp <span style="border: 1px solid black; padding: 0 5px;">  </span> 0rpm             </div>	
Default:	0 rpm
Range:	0 – 4 x Motor Sync Speed

Communication information

Modbus Instance no/ DeviceNet no:	43126
Profibus slot/index	169/30
EtherCAT index (hex)	4c36
Fieldbus format	Int, 1=1 rpm
Modbus format	Int, 1=1 rpm

### Skip Speed 2 High [347]

The same function as menu [345] for the 2nd skip range.

	
Default:	0 rpm
Range:	0 – 4 x Motor Sync Speed

Communication information

Modbus Instance no/ DeviceNet no:	43127
Profibus slot/index	169/31
EtherCAT index (hex)	4c37
Fieldbus format	Int, 1=1 rpm
Modbus format	Int, 1=1 rpm

### Jog Speed [348]

The Jog Speed function is activated by one of the digital inputs. The digital input must be set to the Jog function [520]. The Jog command/function will automatically generate a run command as long as the Jog command/function is active. The rotation is determined by the polarity of the set Jog Speed.

Example

If Jog Speed = -10, this will give a Run Left command at 10 rpm regardless of RunL or RunR commands. Fig. 77 shows the function of the Jog command/function.

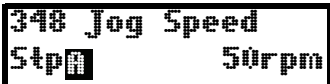
	
Default:	50 rpm
Range:	-4 x motor sync speed to +4 x motor sync speed
Dependent on:	Defined motor sync speed. Max = 400%, normally max=VSD I <sub>max</sub> /motor I <sub>nom</sub> x 100%.

Communication information

Modbus Instance no/ DeviceNet no:	43128
Profibus slot/index	169/32
EtherCAT index (hex)	4c38
Fieldbus format	Int
Modbus format	Int

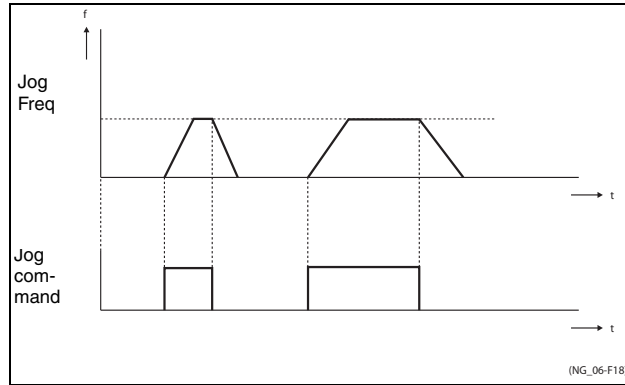

Fig. 77 Jog command

### 11-3-6 Torques [350]

Menu with all parameters for torque settings.

#### Maximum Torque [351]

Sets the maximum motor torque (according to menu group Motor Data [220]). This Maximum Torque operates as an upper torque limit. A Speed Reference is always necessary to run the motor.

$$T_{MOT}(Nm) = \frac{P_{MOT}(w) \times 60}{n_{MOT}(rpm) \times 2\pi} = 100\%$$

Default:	120% calculated from the motor data
Range:	0–400%

#### Communication information

Modbus Instance no/ DeviceNet no:	43141
Profibus slot/index	169/45
EtherCAT index (hex)	4c45
Fieldbus format	Long, 1=1%
Modbus format	EInt

**Note** 100% Torque means:  $I_{NOM} = I_{MOT}$ . The maximum depends on the motor current and VSD max current settings, but the absolute maximum adjustment is 400%. The maximum possible setting for parameter [351] is limited by  $I_{nom}/I_{mot} * 120\%$  but not higher than 400%.

**Note** The power loss in the motor will increase by the square of the torque when operating above 100%. 400% torque will result in 1600% power loss, which will increase the motor temperature very quickly.

#### IxR Compensation [352]

This function compensates for the drop in voltage over different resistances such as (very) long motor cables, chokes and motor stator by increasing the output voltage at a constant frequency. IxR Compensation is most important at low frequencies and is used to obtain a higher starting torque. The maximum voltage increase is 25% of the nominal output voltage. See Fig. 78.

Selecting “Automatic” will use the optimal value according to the internal model of motor. “User-Defined” can be selected when the start conditions of the application do not change and a high starting torque is always required. A fixed IxR Compensation value can be set in the menu [353].

**Note** This menu is visible only in V/Hz mode.

<div style="border: 1px solid black; padding: 5px; display: inline-block;"> <b>352 IxR Comp</b>                  Stp <input type="checkbox"/> Off             </div>		
Default:		Off
Off	0	Function disabled
Automatic	1	Automatic compensation
User Defined	2	User defined value in percent.

Communication information

Modbus Instance no/ DeviceNet no:	43142
Profibus slot/index	169/46
EtherCAT index (hex)	4c46
Fieldbus format	UInt
Modbus format	UInt

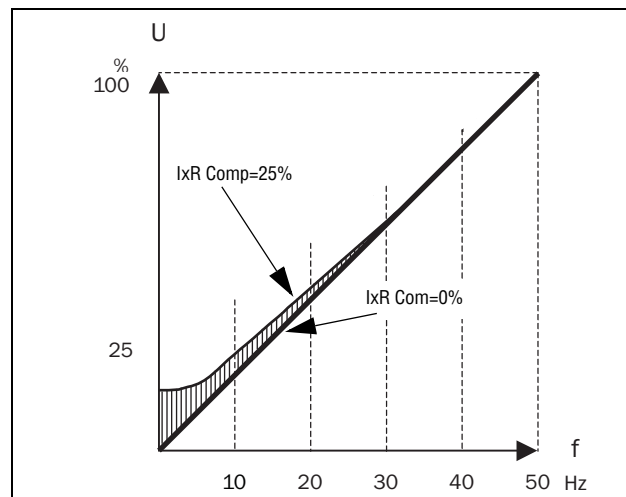

Fig. 78 IxR Comp at Linear V/Hz curve

IxR Comp\_user [353]

Only visible if User-Defined is selected in previous menu.

<div style="border: 1px solid black; padding: 5px; display: inline-block;"> <b>353 IxR CompUser</b>                  Stp <input type="checkbox"/> 0.0%             </div>	
Default:	0.0%
Range:	0-25% x U <sub>NOM</sub> (0.1% of resolution)

Communication information

Modbus Instance no/ DeviceNet no:	43143
Profibus slot/index	169/47
EtherCAT index (hex)	4c47
Fieldbus format	Long
Modbus format	EInt

**Note** A too high level of IxR Compensation could cause motor saturation. This can cause a “Power Fault” trip. The effect of IxR Compensation is stronger with higher power motors.

**Note** The motor may be overheated at low speed. Therefore it is important that the Motor I<sup>2</sup>t Current [232] is set correctly.

### Flux Optimization [354]

Flux Optimization reduces the energy consumption and the motor noise, at low or no load conditions.

Flux Optimization automatically decreases the V/Hz ratio, depending on the actual load of the motor when the process is in a steady situation. Fig. 79 shows the area within which the Flux Optimization is active.

<div style="border: 2px solid black; padding: 5px; display: inline-block;">                 354 Flux optim                  Stp <input type="checkbox"/> Off             </div>		
Default:		Off
Off	0	Function disabled
On	1	Function enabled

#### Communication information

Modbus Instance no/ DeviceNet no:	43144
Profibus slot/index	169/48
EtherCAT index (hex)	4c48
Fieldbus format	UInt
Modbus format	UInt

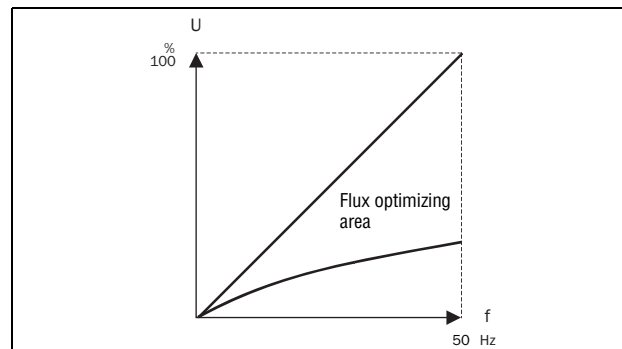

Fig. 79 Flux Optimizing

**Note** Flux optimization works best at stable situations in slow changing processes.

### Maximum power [355]

Sets maximum power. Could be used for limiting motor power in field weakening operation. This function operates as an upper limit and internally limits the parameter Max Torque [351] according to:

$$T_{limit} = P_{limit}[\%] / (\text{Actual speed} / \text{Sync Speed})$$

Flux Optimization automatically decreases the V/Hz ratio, depending on the actual load of the motor when the process is in a steady situation. Fig. 79 shows the area within which the Flux Optimization is active.

<div style="border: 2px solid black; padding: 2px; display: inline-block;"> <b>355 Max Power</b>  <b>Stp <input type="checkbox"/> Off</b> </div>		
Default:		Off
Off	0	Off. No power limit
1 - 400	1 - 400	1 - 400% of motor nominal power

**Note** The maximum possible setting for parameter [355] is limited by  $I_{nom}/I_{mot} * 120\%$  but not higher than 400%.

Communication information

Modbus Instance no/ DeviceNet no:	43145
Profibus slot/index	169/49
EtherCAT index (hex)	4c49
Fieldbus format	Long, 1=1%
Modbus format	EInt

**11-3-7 Preset References [360]**

**Motor Potentiometer [361]**

Sets the properties of the motor potentiometer function. See the parameter DigIn1 [521] for the selection of the motor potentiometer function.

<div style="border: 2px solid black; padding: 2px; display: inline-block;"> <b>361 Motor Pot</b>  <b>Stp <input type="checkbox"/> Non Volatile</b> </div>		
Default:		Non Volatile
Volatile	0	After a stop, trip or power down, the VSD will start always from zero speed (or minimum speed, if selected).
Non volatile	1	Non Volatile. After a stop, trip or power down of the VSD, the reference value at the moment of the stop will be memorized. After a new start command the output speed will resume to this saved value.

Communication information

Modbus Instance no/ DeviceNet no:	43131
Profibus slot/index	169/35
EtherCAT index (hex)	4c3b
Fieldbus format	UInt
Modbus format	UInt

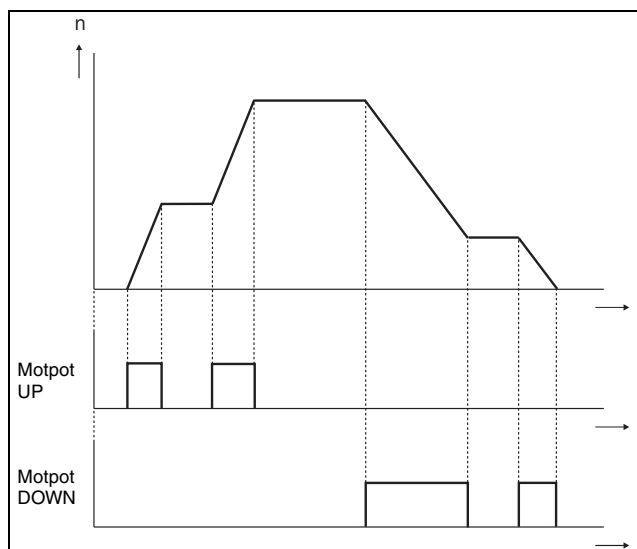

Fig. 80 MotPot function

### Preset Ref 1 [362] to Preset Ref 7 [368]

Preset speeds have priority over the analogue inputs. Preset speeds are activated by the digital inputs. The digital inputs must be set to the function Pres. Ref 1, Pres. Ref 2 or Pres. Ref 4.

Depending on the number of digital inputs used, up to 7 preset speeds can be activated per parameter set. Using all the parameter sets, up to 28 preset speeds are possible.

<b>362 Preset Ref 1</b> <b>Stop 0rpm</b>	
Default:	Speed, 0 rpm
Dependent on:	Process Source [321] and Process Unit [322]
Speed mode	0 - max speed [343]
Torque mode	0 - max torque [351]
Other modes	Min according to menu [324] - max according to menu [325]

#### Communication information

Modbus Instance no/ DeviceNet no:	43132–43138
Profibus slot/index	169/36–169/42
EtherCAT index (hex)	4c3c-4c42
Fieldbus format	Long
Modbus format	EInt

The same settings are valid for the menus:

- [363] Preset Ref 2, with default 250 rpm
- [364] Preset Ref 3, with default 500 rpm
- [365] Preset Ref 4, with default 750 rpm
- [366] Preset Ref 5, with default 1000 rpm
- [367] Preset Ref 6, with default 1250 rpm
- [368] Preset Ref 7, with default 1500 rpm

The selection of the presets is as in Table 25.

Table 25

Preset Ctrl3	Preset Ctrl2	Preset Ctrl1	Output Speed
0	0	0	Analogue reference
0	0	1 <sup>1)</sup>	Preset Ref 1
0	1 <sup>1)</sup>	0	Preset Ref 2
0	1	1	Preset Ref 3
1 <sup>1)</sup>	0	0	Preset Ref 4
1	0	1	Preset Ref 5
1	1	0	Preset Ref 6
1	1	1	Preset Ref 7

<sup>1)</sup>= selected if only one preset reference is active

1 = active input

0 = non active input

**Note** If only Preset Ctrl3 is active, then the Preset Ref 4 can be selected. If Presets Ctrl2 and 3 are active, then the Preset Ref 2, 4 and 6 can be selected.

### Keyboard reference mode [369]

This parameter sets how the reference value [310] is edited.

369 Key Ref Mode		Stop	MotPot
Default:		MotPot	
Normal	0	The reference value is edited as a normal parameter (the new reference value is activated when Enter is pressed after the value has been changed). The Acc Time [331] and Dec Time [332] are used.	
MotPot	1	The reference value is edited using the motor potentiometer function (the new reference value is activated directly when the key + or - is pressed). The Acc MotPot [333] and Dec MotPot [334] are used.	

#### Communication information

Modbus Instance no/ DeviceNet no:	43139
Profibus slot/index	169/43
EtherCAT index (hex)	4c43
Fieldbus format	UInt
Modbus format	UInt

**Note** When Key Ref Mode is set to MotPot, the reference value ramp times are according to the Acc MotPot [333] and Dec MotPot [334] settings. Actual speed ramp will be limited according to Acc Time [331] and Dec Time [332].

### 11-3-8 PI Speed Control [370]

The VSD has an internal speed controller, which is used to keep the shaft speed equal to the set speed reference. This internal speed controller works without an external feedback.

With the parameters speed P gain [372] and speed I time [373] the controller can be optimized manually.



### Speed PI Autotune [371]

The function speed autotune will perform a torque step change, and measures the reaction on shaft speed.

It automatically sets the internal speed I time to its optimum value. The speed PI autotune must be done during operation with the motor load connected and the motor running. “Spd PI Auto” will be blinking in the display during the autotune operation. When the test is successfully concluded, the display will show “Spd PI OK!” for 3 s.

Default:	Off
Off	0
On	1

#### Communication information

Modbus Instance no/ DeviceNet no:	43151
Profibus slot/index	169/55
EtherCAT index (hex)	4c4f
Fieldbus format	UInt
Modbus format	UInt

**Note** Run the autotune at speed lower than 80% of the nominal motor speed. Otherwise autotune will fail.

**Note** The setting will automatically return to Off when the autotuning is finished.

**Note** This menu is only visible if VSD Mode = Speed or V/Hz.

### Speed P Gain [372]

For adjusting the P gain of the internal speed controller. The speed P gain must be manually tuned for a faster reaction to load changes. The speed P gain can be increased until there is audible noise from the motor and then decreased until the noise disappears.

Default:	See note
Range:	0.0–60.0

#### Communication information

Modbus Instance no/ DeviceNet no:	43152
Profibus slot/index	169/56
EtherCAT index (hex)	4c50
Fieldbus format	Long, 1=0.1
Modbus format	EInt

### Speed I Time [373]

To adjust the time of the internal speed controller see parameter Speed PI Autotune [371].

	
Default:	See note
Range:	0.05–100 s

#### Communication information

Modbus Instance no/ DeviceNet no:	43153
Profibus slot/index	169/57
EtherCAT index (hex)	4c51
Fieldbus format	Long, 1=0.01 s
Modbus format	EInt

**Note** The default settings are calculated for a standard 4-pole motor without load according to the nominal power of the VSD.

## 11-3-9 PID Process Control [380]

The PID controller is used to control an external process via a feedback signal. The reference value can be set via analogue input AnIn1, at the Control Panel [310] by using a Preset Reference, or via serial communication. The feedback signal (actual value) must be connected to an analogue input that is set to the function Process Value.

### Process PID Control [381]

This function enables the PID controller and defines the response to a changed feedback signal.

		
Default:	Off	
Off	0	PID control deactivated.
On	1	The speed increases when the feedback value decreases. PID settings according to menus [383] to [385].
Invert	2	The speed decreases when the feedback value decreases. PID settings according to menus [383] to [385].

#### Communication information

Modbus Instance no/ DeviceNet no:	43154
Profibus slot/index	169/58
EtherCAT index (hex)	4c52
Fieldbus format	UInt
Modbus format	UInt

### PID P Gain [383]

Setting the P gain for the PID controller.

	<div style="border: 1px solid black; padding: 2px;"> <b>383 PID P Gain</b>                  Stp <span style="float: right;">1.0</span> </div>
Default:	1.0
Range:	0.0–30.0

#### Communication information

Modbus Instance no/ DeviceNet no:	43156
Profibus slot/index	169/60
EtherCAT index (hex)	4c54
Fieldbus format	Long, 1=0.1
Modbus format	EInt

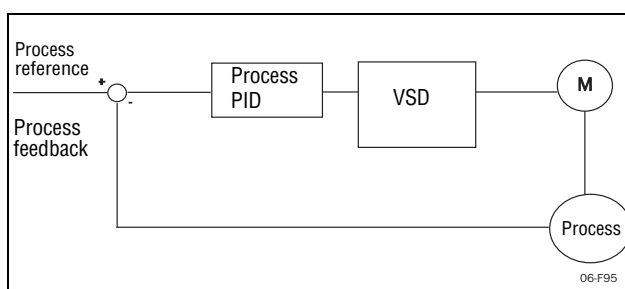

Fig. 81 Closed loop PID control

### PID I Time [384]

Setting the integration time for the PID controller.

	<div style="border: 1px solid black; padding: 2px;"> <b>384 PID I Time</b>                  Stp <span style="float: right;">1.00s</span> </div>
Default:	1.00 s
Range:	0.01–300 s

#### Communication information

Modbus Instance no/ DeviceNet no:	43157
Profibus slot/index	169/61
EtherCAT index (hex)	4c55
Fieldbus format	Long, 1=0.01 s
Modbus format	EInt

### Process PID D Time [385]

Setting the differentiation time for the PID controller.

	<div style="border: 1px solid black; padding: 2px;"> <b>385 PID D Time</b>                  Stp <span style="float: right;">0.00s</span> </div>
Default:	0.00 s
Range:	0.00–30 s

Communication information

Modbus Instance no/ DeviceNet no:	43158
Profibus slot/index	169/62
EtherCAT index (hex)	4c56
Fieldbus format	Long, 1=0.01 s
Modbus format	EInt

### PID sleep functionality

This function is controlled via a wait delay and a separate wake-up margin condition. With this function it is possible to put the VSD in “sleep mode” when the process value is at its set point and the motor is running at minimum speed for the length of the time set in [386]. By going into sleep mode, the by the application consumed energy is reduced to a minimum. When the process feedback value goes below the set margin on the process reference as set in [387], the VSD will wake up automatically and normal PID operation continues, see examples.

**Note** When the VSD is in Sleep mode, this is indicated with “slp” in the lower left corner of the display.

### PID sleep when less than minimum speed [386]

If the PID output is equal to or less than minimum speed for given delay time, the VSD will go to sleep.

	
Default:	Off
Range:	Off, 0.01 –3600 s

#### Communication information

Modbus Instance no/ DeviceNet no:	43371
Profibus slot/index	170/20
EtherCAT index (hex)	4d2b
Fieldbus format	Long, 1=0.01 s
Modbus format	EInt

**Note** Menu [386] has higher priority than menu [342].

### PID Activation Margin [387]

The PID activation (wake-up) margin is related to the process reference and sets the limit when the VSD should wake-up/start again.

	
Default:	0
Range:	0 –10000 in Process unit

#### Communication information

Modbus Instance no/ DeviceNet no:	43372
Profibus slot/index	170/21
EtherCAT index (hex)	4d2c
Fieldbus format	Long
Modbus format	EInt

**Note** The margin is always a positive value.

Example 1 PID control = normal (flow or pressure control)

[321] = F (AnIn)

[322] = Bar

[310] = 20 Bar

[342] = 2 s (inactive since [386] is activated and have higher priority)  
 [381]= On  
 [386] = 10 s  
 [387] = 1 Bar

The VSD will stop/sleep when the speed (PID output) is below or equal to Min Speed for 10 seconds. The VSD will activate/wake up when the “Process value” goes below the PID Activation Margin which is related to the process reference, i.e. goes below (20-1) Bar. See Fig. 82.

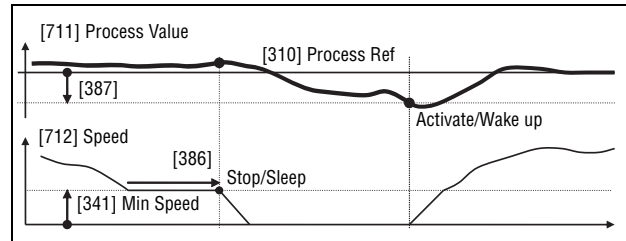

Fig. 82 PID Stop/sleep with normal PID

Example 2 PID control = inverted (tank level control)

[321] = F (AnIn)  
 [322] = m  
 [310] = 7 m  
 [342] = 2 s (inactive since [386] is activated and have higher priority)  
 [381]= Inverted  
 [386] = 30 s  
 [387] = 1 m

The VSD will stop/sleep when the speed (PID output) is below or equal to Min Speed for 30 seconds. The VSD will activate/wake up when the “Process value” goes above the PID Activation Margin which is related to the process reference, i.e. goes above (7+1) m. See Fig. 83.

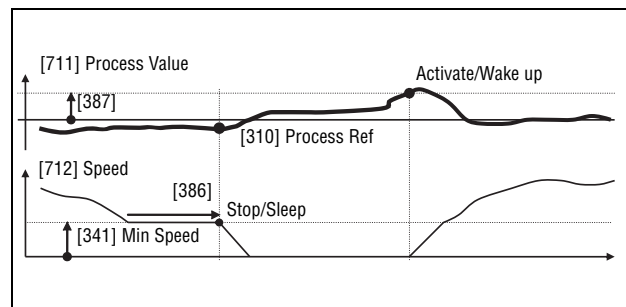

Fig. 83 PID Stop/sleep with inverted PID

PID Steady State Test [388]

In application situations where the feedback can become independent of the motor speed, this PID Steady Test function can be used to overrule the PID operation and force the VSD to go in sleep mode i.e. the VSD automatically reduces the output speed while at the same time ensures the process value.

Example: pressure controlled pump systems with low/no flow operation and where the process pressure has become independent of the pump speed, e.g. due to slowly closed valves. By going into Sleep mode, heating of the pump and motor will be avoided and no energy is spilled.

PID Steady state test delay.

**Note** It is important that the system has reached a stable situation before the Steady State Test is initiated.

	
Default:	Off
Range:	Off, 0.01–3600 s

Communication information

Modbus Instance no/ DeviceNet no:	43373
Profibus slot/index	170/22
EtherCAT index (hex)	4d2d
Fieldbus format	Long, 1=0.01 s
Modbus format	EInt

### PID Steady State Margin [389]

PID steady state margin defines a margin band around the reference that defines “steady state operation”. During the steady state test the PID operation is overruled and the VSD is decreasing the speed as long as the PID error is within the steady state margin. If the PID error goes outside the steady state margin the test failed and normal PID operation continues, see example.

	
Default:	0
Range:	0–10000 in process unit

Communication information

Modbus Instance no/ DeviceNet no:	43374
Profibus slot/index	170/23
EtherCAT index (hex)	4d2e
Fieldbus format	Long, 1=0.01 s
Modbus format	EInt

Example: The PID Steady Test starts when the process value [711] is within the margin and Steady State Test Wait Delay has expired. The PID output will decrease speed with a step value which corresponds to the margin as long as the Process value [711] stays within steady state margin. When Min Speed [341] is reached the steady state test was successful and stop/sleep is commanded if PID sleep function [386] and [387] is activated. If the Process value [711] goes outside the set steady state margins then the test failed and normal PID operation will continue, see Fig. 84.

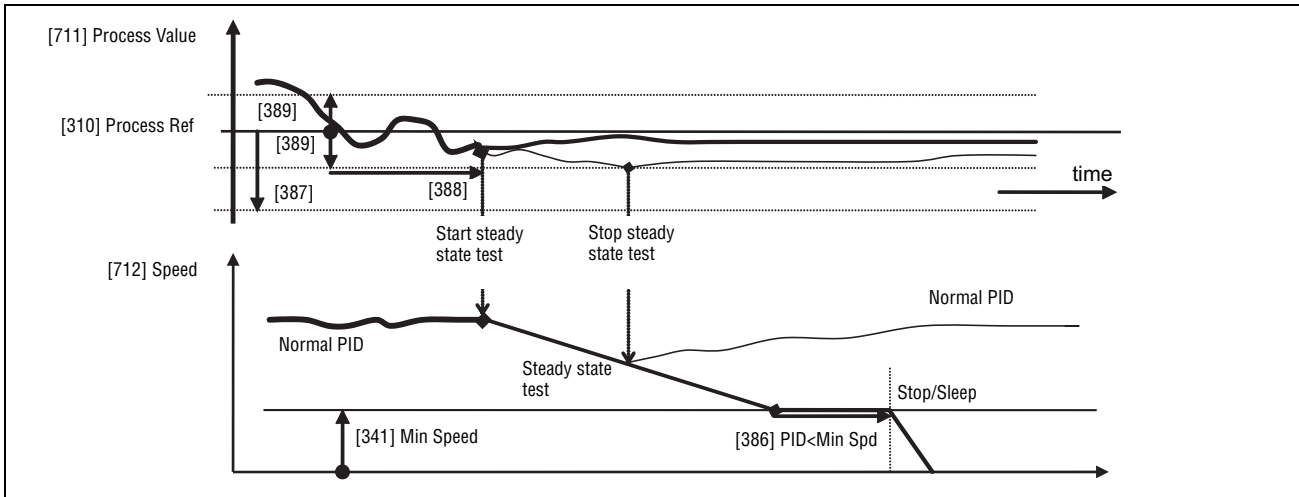

Fig. 84 Steady state test

### Pump/Fan Control [390]

The Pump Control functions are in menu [390]. The function is used to control a number of drives (pumps, fans, etc.) of which one is always driven by the VSD.

### Pump enable [391]

This function will enable the pump control to set all relevant pump control functions.

		<b>391 Pump enable</b> Stp <input type="checkbox"/> Off
Default:		Off
Off	0	Pump control is switched off.
On	1	Pump control is on: - Pump control parameters [392] to [39G] appear and are activated according to default settings. - View functions [39H] to [39M] are added in the menu structure.

#### Communication information

Modbus Instance no/ DeviceNet no:	43161
Profibus slot/index	169/65
EtherCAT index (hex)	4c59
Fieldbus format	UInt
Modbus format	UInt

### Number of Drives [392]

Sets the total number of drives which are used, including the Master VSD. The setting here depends on the parameter Select Drive [393]. After the number of drives is chosen it is important to set the relays for the pump control. If



the digital inputs are also used for status feedback, these must be set for the pump control according to; Pump 1 OK– Pump6 OK in menu [520].

	
Default:	1
1-3	Number of drives if I/O Board is not used.
1-6	Number of drives if 'Alternating MASTER' is used, see Select Drive [393]. (I/O Board is used.)
1-7	Number of drives if 'Fixed MASTER' is used, see Select Drive [393]. (I/O Board is used.)

**Note** Used relays must be defined as Slave Pump or Master Pump. Used digital inputs must be defined as Pump Feedback.

Communication information

Modbus Instance no/ DeviceNet no:	43162
Profibus slot/index	169/66
EtherCAT index (hex)	4c5a
Fieldbus format	UInt
Modbus format	UInt

### Select Drive [393]

Sets the main operation of the pump system. 'Sequence' and 'Runtime' are Fixed MASTER operation. 'All' means Alternating MASTER operation.

	
Default:	Sequence
Sequence	0 Fixed MASTER operation: - The additional drives will be selected in sequence, i.e. first pump 1 then pump 2 etc. - A maximum of 7 drives can be used.
Run Time	1 Fixed MASTER operation: - The additional drives will be selected depending on the Run Time. So the drive with the lowest Run Time will be selected first. The Run Time is monitored in menus [39H] to [39M] in sequence. For each drive the Run Time can be reset. - When drives are stopped, the drive with the longest Run Time will be stopped first. - Maximum 7 drives can be used.
All	2 Alternating MASTER operation: - When the drive is powered up, one drive is selected as the Master drive. The selection criteria depends on the Change Condition [394]. The drive will be selected according to the Run Time. So the drive with the lowest Run Time will be selected first. The Run Time is monitored in menus [39H] to [39M] in sequence. For each drive the Run Time can be reset. - A maximum of 6 drives can be used.

Communication information

Modbus Instance no/ DeviceNet no:	43163
Profibus slot/index	169/67
EtherCAT index (hex)	4c5b
Fieldbus format	UInt
Modbus format	UInt

**Note** This menu will NOT be active if less than 3 drives are selected.

### Change Condition [394]

This parameter determines the criteria for changing the master. This menu only appears if Alternating MASTER operation is selected. The elapsed run time of each drive is monitored. The elapsed run time always determines which drive will be the 'new' master drive.

This function is only active if the parameter Select Drive [393]=All.

		
Default:		Both
Stop	0	<p>The Runtime of the master drive determines when a master drive has to be changed. The change will only take place after a:</p> <ul style="list-style-type: none"> <li>- Power Up</li> <li>- Stop</li> <li>- Standby condition</li> <li>- Trip condition.</li> </ul>
Timer	1	<p>The master drive will be changed if the timer setting in Change Timer [395] has elapsed. The change will take place immediately. So during operation the additional pumps will be stopped temporarily, the 'new' master will be selected according to the Run Time and the additional pumps will be started again.</p> <p>It is possible to leave 2 pumps running during the change operation. This can be set with Drives on Change [396].</p>
Both	2	<p>The master drive will be changed if the timer setting in Change Timer [395] has elapsed. The 'new' master will be selected according to the elapsed Run Time. The change will only take place after a:</p> <ul style="list-style-type: none"> <li>- Power Up</li> <li>- Stop</li> <li>- Standby condition.</li> <li>- Trip condition.</li> </ul>

Communication information

Modbus Instance no/ DeviceNet no:	43164
Profibus slot/index	169/68
EtherCAT index (hex)	4c5c
Fieldbus format	UInt
Modbus format	UInt

**Note** If the Status feedback inputs (DigIn 9 to Digin 14) are used, the master drive will be changed immediately if the feedback generates an 'Error'.

### Change Timer [395]

When the time set here is elapsed, the master drive will be changed. This function is only active if Select Drive [393]=All and Change Cond [394]=Timer/ Both.

<div style="border: 2px solid black; padding: 2px; display: inline-block;"> <b>395 Change Timer</b>            Stp <input type="checkbox"/> 50h         </div>	
Default:	50 h
Range:	1-3000 h

#### Communication information

Modbus Instance no/ DeviceNet no:	43165
Profibus slot/index	169/69
EtherCAT index (hex)	4c5d
Fieldbus format	UInt, 1=1 h
Modbus format	UInt, 1=1 h

### Drives on Change [396]

If a master drive is changed according to the timer function (Change Condition=Timer/Both [394]), it is possible to leave additional pumps running during the change operation. With this function the change operation will be as smooth as possible. The maximum number to be programmed in this menu depends on the number of additional drives.

#### Example:

If the number of drives is set to 6, the maximum value will be 4. This function is only active if Select Drive [393]=All.

<div style="border: 2px solid black; padding: 2px; display: inline-block;"> <b>396 Drives on Ch</b>            Stp <input type="checkbox"/> 0         </div>	
Default:	0
Range:	0 to (the number of drives - 2)

#### Communication information

Modbus Instance no/ DeviceNet no:	43166
Profibus slot/index	169/70
EtherCAT index (hex)	4c5e
Fieldbus format	UInt
Modbus format	UInt

### Upper Band [397]

If the speed of the master drive comes into the upper band, an additional drive will be added after a delay time that is set in start delay [399].

<div style="border: 2px solid black; padding: 2px; display: inline-block;"> <b>397 Upper Band</b>            Stp <input type="checkbox"/> 10%         </div>	
Default:	10%
Range:	0-100% of total min speed to max speed

Communication information

Modbus Instance no/ DeviceNet no:	43167
Profibus slot/index	169/71
EtherCAT index (hex)	4c5f
Fieldbus format	Long, 1=1%
Modbus format	EInt

Example:

Max Speed = 1500 rpm  
 Min Speed = 300 rpm  
 Upper Band = 10%

Start delay will be activated:

Range = Max Speed to Min Speed = 1500–300 = 1200 rpm  
 10% of 1200 rpm = 120 rpm  
 Start level = 1500–120 = 1380 rpm

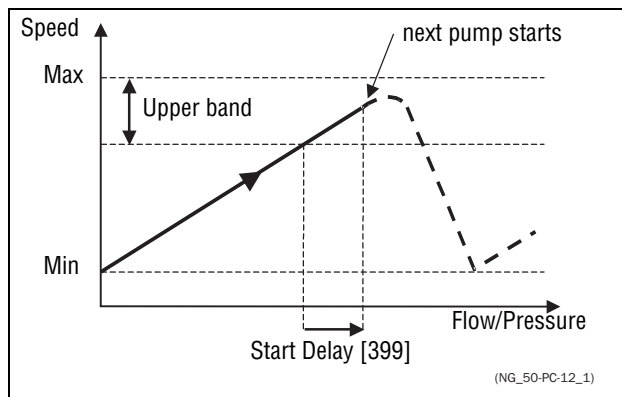

Fig. 85 Upper band

Lower Band [398]

If the speed of the master drive comes into the lower band an additional drive will be stopped after a delay time. This delay time is set in the parameter Stop Delay [39A].

<b>398 Lower Band</b> <b>Stop Delay 10%</b>	
Default:	10%
Range:	0-100% of total min speed to max speed

Communication information

Modbus Instance no/ DeviceNet no:	43168
Profibus slot/index	169/72
EtherCAT index (hex)	4c60
Fieldbus format	Long, 1=1%
Modbus format	EInt

Example:

Max Speed = 1500 rpm  
 Min Speed = 300 rpm  
 Lower Band = 10%

Stop delay will be activated:  
 Range = Max Speed - Min Speed = 1500-300 = 1200 rpm  
 10% of 1200 rpm = 120 rpm  
 Start level = 300 + 120 = 420 rpm

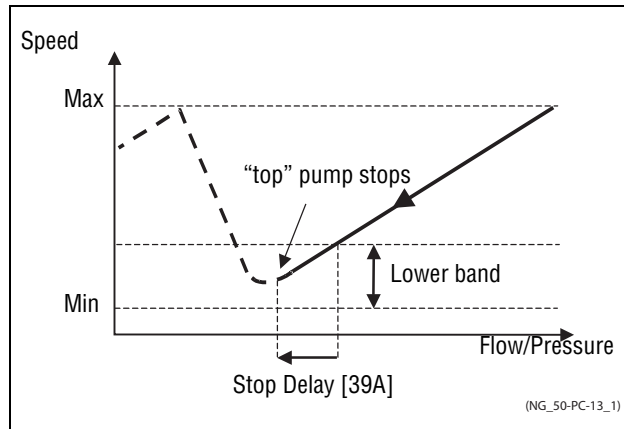

Fig. 86 Lower band

### Start Delay [399]

This delay time must have elapsed before the next pump is started. A delay time prevents the nervous switching of pumps.

<div style="border: 2px solid black; padding: 5px; display: inline-block;">                 399 Start Delay                  Stop 0s             </div>	
Default:	0 s
Range:	0-999 s

#### Communication information

Modbus Instance no/ DeviceNet no:	43169
Profibus slot/index	169/73
EtherCAT index (hex)	4c61
Fieldbus format	Long, 1=1s
Modbus format	EInt

### Stop Delay [39A]

This delay time must have elapsed before the 'top' pump is stopped. A delay time prevents the nervous switching of pumps.

<div style="border: 2px solid black; padding: 5px; display: inline-block;">                 39A Stop Delay                  Stop 0s             </div>	
Default:	0 s
Range:	0-999 s

#### Communication information

Modbus Instance no/ DeviceNet no:	43170
Profibus slot/index	169/74
EtherCAT index (hex)	4c62
Fieldbus format	Long, 1=1 s
Modbus format	EInt

### Upper Band Limit [39B]

If the speed of the pump reaches the upper band limit, the next pump is started immediately without delay. If a start delay is used this delay will be ignored. Range is between 0%, equalling max speed, and the set percentage for the UpperBand [397].

<b>39B Upp Band Lim</b> <b>Stp % 0%</b>	
Default:	0%
Range:	0 to Upper Band level. 0% (=max speed) means that the Limit function is switched off.

#### Communication information

Modbus Instance no/ DeviceNet no:	43171
Profibus slot/index	169/75
EtherCAT index (hex)	4c63
Fieldbus format	Long, 1=1%
Modbus format	EInt

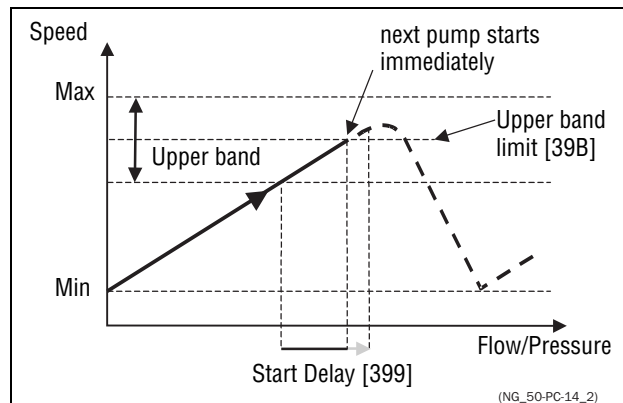

Fig. 87 Upper band limit

### Lower Band Limit [39C]

If the speed of the pump reaches the lower band limit, the 'top' pump is stopped immediately without delay. If a stop delay is used this delay will be ignored. Range is from 0%, equalling min speed, to the set percentage for the Lower Band [398].

<b>39C Low Band Lim</b> <b>Stp % 0%</b>	
Default:	0%
Range:	0 to Lower Band level. 0% (=min speed) means that the Limit function is switched off.

#### Communication information

Modbus Instance no/ DeviceNet no:	43172
Profibus slot/index	169/76
EtherCAT index (hex)	4c64
Fieldbus format	Long, 1=1%
Modbus format	EInt

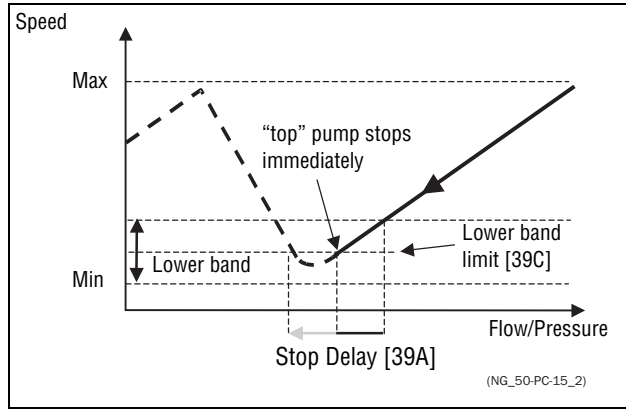

Fig. 88 Lower band limit

### Settle Time Start [39D]

The settle start allows the process to settle after a pump is switched on before the pump control continues. If an additional pump is started D.O.L. (Direct On Line) or Y/ Δ, the flow or pressure can still fluctuate due to the 'rough' start/stop method. This could cause unnecessary starting and stopping of additional pumps.

During the Settle start:

- PID controller is off.
- The speed is kept at a fixed level after adding a pump.

Default:	0 s
Range:	0-999 s

#### Communication information

Modbus Instance no/ DeviceNet no:	43173
Profibus slot/index	169/77
EtherCAT index (hex)	4c65
Fieldbus format	Long, 1=1 s
Modbus format	EInt

### Transition Speed Start [39E]

The transition speed start is used to minimize a flow/pressure overshoot when adding another pump. When an additional pump needs to be switched on, the master pump will slow down to the set transition speed start value, before the additional pump is started. The setting depends on the dynamics of both the master drive and the additional drives.

The transition speed is best set by trial and error.

In general:

- If the additional pump has 'slow' start/stop dynamics, then a higher transition speed should be used.
- If the additional pump has 'fast' start/stop dynamics, then a lower transition

speed should be used.

Default:	60%
Range:	0-100% of total min speed to max speed

Communication information

Modbus Instance no/ DeviceNet no:	43174
Profibus slot/index	169/78
EtherCAT index (hex)	4c67
Fieldbus format	Long, 1=1%
Modbus format	EInt

Example

Max Speed = 1500 rpm  
 Min Speed = 200 rpm  
 TransS Start = 60%

When an additional pump is needed, the speed will be controlled down to min speed + (60% x (1500 rpm - 200 rpm)) = 200 rpm + 780 rpm = 980 rpm. When this speed is reached, the additional pump with the lowest run time hours will be switched on.

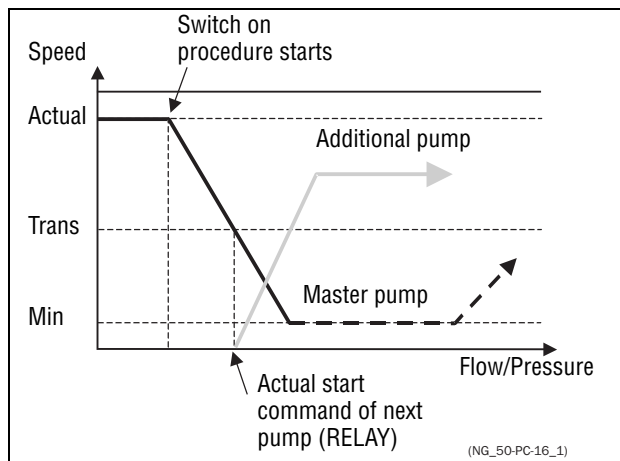

Fig. 89 Transition speed start

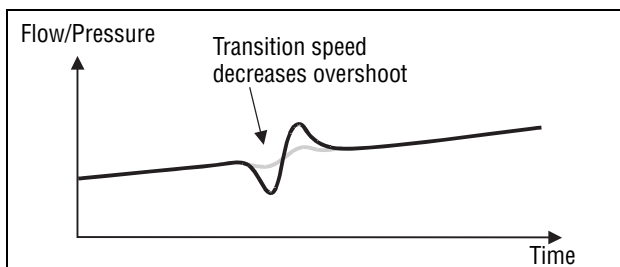

Fig. 90 Effect of transition speed

Settle Time Stop [39F]

The settle stop allows the process to settle after a pump is switched off before the pump control continues. If an additional pump is stopped D.O.L. (Direct On Line) or Y/ Δ, the flow or pressure can still fluctuate due to the 'rough' start/



stop method. This could cause unnecessary starting and stopping of additional pumps.

During the Settle stop:

- PID controller is off.
- the speed is kept at a fixed level after stopping a pump

	
Default:	0 s
Range:	0–999 s

Communication information

Modbus Instance no/ DeviceNet no:	43175
Profibus slot/index	169/79
EtherCAT index (hex)	4c67
Fieldbus format	Long, 1=1 s
Modbus format	EInt

### Transition Speed Stop [39G]

The transition speed stop is used to minimize a flow/pressure overshoot when shutting down an additional pump. The setting depends on the dynamics of both the master drive and the additional drives.

In general:

- If the additional pump has 'slow' start/stop dynamics, then a higher transition speed should be used.
- If the additional pump has 'fast' start/stop dynamics, then a lower transition speed should be used.

	
Default:	60%
Range:	0-100% of total min speed to max speed

Communication information

Modbus Instance no/ DeviceNet no:	43176
Profibus slot/index	169/80
EtherCAT index (hex)	4c68
Fieldbus format	Long, 1=1%
Modbus format	EInt

### Example

Max Speed = 1500 rpm  
 Min Speed = 200 rpm  
 TransS Start = 60%

When less additional pumps are needed, the speed will be controlled up to min speed + (60% x (1500 rpm - 200 rpm)) = 200 rpm + 780 rpm = 980 rpm. When this speed is reached, the additional pump with the highest run time hours will be switched off.

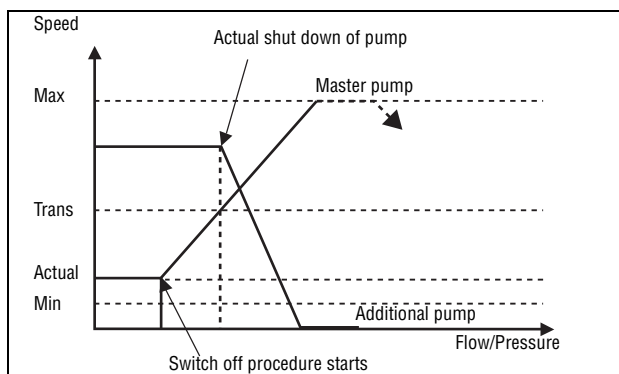

Fig. 91 Transition speed stop

Run Times 1-6 [39H] to [39M]

<div style="border: 2px solid black; padding: 5px; display: inline-block;"> <b>39H Run Time 1</b>  <b>Stop h:mm:ss</b> </div>	
Unit:	h:mm:ss (hours:minutes:seconds)
Range:	00:00:00 – 262143:59:59

Communication information

Modbus Instance no/ DeviceNet no:	31051: 31052 : 31053 (hr:min:sec) 31054: 31055 : 31056 (hr:min:sec) 31057: 31058 : 31059 (hr:min:sec) 31060: 31061 : 31062 (hr:min:sec) 31063: 31064 : 31065 (hr:min:sec) 31066: 31067 : 31068 (hr:min:sec)
Profibus slot/index	121/195, 121/196, 121/197 121/198, 121/199, 121/200 121/201, 121/202, 121/203 121/204, 121/205, 121/206 121/207, 121/208, 121/209 121/210, 121/211, 121/212
EtherCAT index (hex)	241b : 241c : 241d 241e : 241f : 2420 2421 : 2422 : 2423 2424 : 2425 : 2426 2427 : 2428 : 2429 242a : 242b : 242c
Fieldbus format	Long, 1=1h/m/s
Modbus format	EInt, 1=1h/m/s

Reset Run Times 1-6 [39H1] to [39M1]

Default:	No
No	0
Yes	1

Communication information

Modbus Instance no/ DeviceNet no:	38-43, pump 1 -6
Profibus slot/index	0/37-0/42
EtherCAT index (hex)	2026 - 202b
Fieldbus format	UInt
Modbus format	UInt

Pump Status [39N]

--	--

Indication	Description
C	Control, master pump, only when alternating master is used
D	Direct control
O	Pump is off
E	Pump error

Number backup/reserve [39P]

Sets the number of pumps used for backup/reserve which in normal conditions can not be selected. This function can be used for increasing redundancy in the pump system by having pumps in reserve that can be activated when some pumps indicate fault or are shut off for maintenance.

Default:	0
Range:	0-3

Communication information

Modbus Instance no/ DeviceNet no:	43177
Profibus slot/index	169/81
EtherCAT index (hex)	4c69
Fieldbus format	UInt
Modbus format	UInt

11-3-10 Crane Option [3A0]

Settings for the optional Crane board (Crane Remote Input/Output card). See also the Crane option instruction manual.

**Note** This menu is only visible if the crane board is connected to the VSD.

### Crane enable [3A1]

When the crane option board is connected, it is possible to (de)activate the crane option board inputs.

**Note** Deviation function is active even if [3A1]=off.

		
Default:		Off
Off	0	Crane option board deactivated
On	1	Crane option board activated

#### Communication information

Modbus Instance no/ DeviceNet no:	43181
Profibus slot/index	169/85
EtherCAT index (hex)	4c6d
Fieldbus format	UInt
Modbus format	UInt

### Control [3A2]

To select the type of crane joystick control.

		
Default:		4-Speeds
4-Speeds	0	4-Speed joystick
3-Pos	1	3-Position switch
Analogue	2	Analogue joystick

#### Communication information

Modbus Instance no/ DeviceNet no:	43182
Profibus slot/index	169/86
EtherCAT index (hex)	4c6e
Fieldbus format	UInt
Modbus format	UInt

### Crane Relay CR1 [3A3]

Crane Relay CR1 on the Crane option board is fixed to the No Trip function.

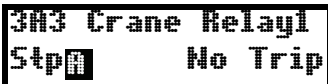
	
Default:	No Trip
Selections	Fixed to No Trip

#### Communication information

Modbus Instance no/ DeviceNet no:	43183
Profibus slot/index	169/87

EtherCAT index (hex)	4c6f
Fieldbus format	UInt
Modbus format	UInt

### Crane Relay CR2 [3A4]

To select the function of Crane Relay CR2 on the Crane option board. Same selections as for the relays on the control board.

	<b>3A4 Crane Relay2</b> Stp <input type="checkbox"/> Brake
Default:	Brake
Selections	Same selections as for the relays on the control board

#### Communication information

Modbus Instance no/ DeviceNet no:	43184
Profibus slot/index	169/88
EtherCAT index (hex)	4c70
Fieldbus format	UInt
Modbus format	UInt

### Pre Limit Switch Speed [3A5]

To set the speed used when Pre-Limit Switch on the Crane option board is active.

	<b>3A5 PreLimSwSpd</b> Stp <input type="checkbox"/> rpm
Default:	0 rpm
Range:	0 – 4 x Motor Sync speed

#### Communication information

Modbus Instance no/ DeviceNet no:	43185
Profibus slot/index	169/89
EtherCAT index (hex)	4c71
Fieldbus format	Int, 1=1 rpm
Modbus format	Int, 1=1 rpm

### Crawl speed H/R [3A6]

To set the speed used when crawling (min. speed) during a hoisting operation. Activated with input A1, Crawl H/R=Start in positive speed direction

	<b>3A6 CrawlSpd H/R</b> Stp <input type="checkbox"/> rpm
Default:	0
Range:	0 – 4 x Sync speed

#### Communication information

Modbus Instance no/ DeviceNet no:	43189
Profibus slot/index	169/93
EtherCAT index (hex)	4c75

Fieldbus format	Int, 1=1 rpm
Modbus format	Int, 1=1 rpm

### Crawl speed L/L [3A7]

To set the speed used when crawling (min. speed) during lowering operation. Activated with input A2, Crawl L/L=Start in negative speed direction.

	
Default:	0
Range:	0 – 4 x Sync speed

#### Communication information

Modbus Instance no/ DeviceNet no:	43190
Profibus slot/index	169/94
EtherCAT index (hex)	4c76
Fieldbus format	Int, 1=1 rpm
Modbus format	Int, 1=1 rpm

### Speed 2 [3A8]

To set the speed used when the input B1, Speed 2 on the Crane option board is active.

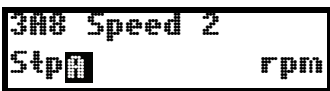
	
Default:	0
Range:	0 – 4 x Sync speed

#### Communication information

Modbus Instance no/ DeviceNet no:	43186
Profibus slot/index	169/90
EtherCAT index (hex)	4c72
Fieldbus format	Int, 1=1 rpm
Modbus format	Int, 1=1 rpm

### Speed 3 [3A9]

To set the speed used when the input B2, Speed 3 on the Crane option board is active.

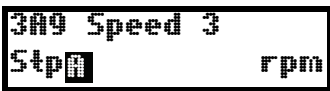
	
Default:	0
Range:	0 – 4 x Motor Sync speed

#### Communication information

Modbus Instance no/ DeviceNet no:	43187
Profibus slot/index	169/91
EtherCAT index (hex)	4c73

Fieldbus format	Int
Modbus format	Int

### Speed 4 [3AA]

To set the speed used when the input B3, Speed 4 on the Crane option board is active.

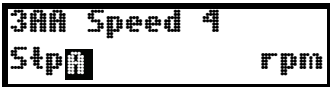
	
Default:	0
Range:	0 – 4 x Motor Sync speed

#### Communication information

Modbus Instance no/ DeviceNet no:	43188
Profibus slot/index	169/92
EtherCAT index (hex)	4c74
Fieldbus format	Int
Modbus format	Int

### Deviation Band width [3AB]

To define the speed deviation window within which the VSD is in control of the motor.

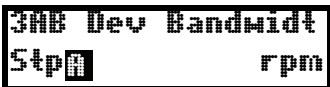
	
Default:	0
Range:	0 – 4 x Sync speed

#### Communication information

Modbus Instance no/ DeviceNet no:	43191
Profibus slot/index	169/95
EtherCAT index (hex)	4c77
Fieldbus format	Int, 1=1 rpm
Modbus format	Int, 1=1 rpm

### Deviation Time [3AC]

To set the time during which the deviation condition must be active, before the inverter trips.

	
Default:	0.10 s
Range:	0.05 – 1 s

#### Communication information

Modbus Instance no/ DeviceNet no:	43192
Profibus slot/index	169/96
EtherCAT index (hex)	4c78

Fieldbus format	Long, 1=0.001 s
Modbus format	EInt

### LAFS Load [3AD]

To set the load below which the SX-F goes into load dependent field weakening operation.

	
Default:	Off
Off	0
1-100	1-100
	1% - 100%

#### Communication information

Modbus Instance no/ DeviceNet no:	43193
Profibus slot/index	169/97
EtherCAT index (hex)	4c79
Fieldbus format	Long, 1=1%
Modbus format	EInt

When set to OFF, the load dependent field weakening function is switched off.

### CRIO N Input function [3AG]

Set the function of CRIO/Crane I/O interface N (null) input.

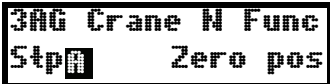
	
Default:	Zero Pos
Off	0
Zero pos	1
Brk Ackn	2
	N input not used
	N input used for joystick zero position indication
	N input used for Brake Acknowledge.

#### Communication information

Modbus Instance no/ DeviceNet no:	43194
Profibus slot/index	169/98
EtherCAT index (hex)	4c7a
Fieldbus format	UInt
Modbus format	UInt

Brake Acknowledge via Crane I/O has priority (and overrules) Brake Acknowledge via control board I/O ([521 DigIn1] - [528 DigIn8]).



## 11-4 Load Monitor and Process Protection [400]

### 11-4-1 Load Monitor [410]

The monitor functions enable the VSD to be used as a load monitor. Load monitors are used to protect machines and processes against mechanical overload and underload, e.g. a conveyer belt or screw conveyer jamming, belt failure on a fan and a pump dry running. See explanation in section 7-5, page 62.

#### Alarm Select [411]

Selects the types of alarms that are active.

		
Default:		Off
Off	0	No alarm functions active.
Min	1	Min Alarm active. The alarm output functions as an underload alarm.
Max	2	Max Alarm active. The alarm output functions as an overload alarm.
Max+Min	3	Both Max and Min alarm are active. The alarm outputs function as overload and underload alarms.

#### Communication information

Modbus Instance no/ DeviceNet no:	43321
Profibus slot/index	169/225
EtherCAT index (hex)	4cf9
Fieldbus format	UInt
Modbus format	UInt

#### Alarm Trip [412]

Selects which alarm must cause a trip to the VSD.

	
Default:	Off
Selection:	Same as in menu [411]

#### Communication information

Modbus Instance no/ DeviceNet no:	43322
Profibus slot/index	169/226
EtherCAT index (hex)	4cfa
Fieldbus format	UInt
Modbus format	UInt

## Ramp Alarm [413]

This function inhibits the (pre) alarm signals during acceleration/deceleration of the motor to avoid false alarms.

	
Default:	Off
Off	0 (Pre) alarms are inhibited during acceleration/deceleration.
On	1 (Pre) alarms active during acceleration/deceleration.

### Communication information

Modbus Instance no/ DeviceNet no:	43323
Profibus slot/index	169/227
EtherCAT index (hex)	4cfb
Fieldbus format	UInt
Modbus format	UInt

## Alarm Start Delay [414]

This parameter is used if, for example, you want to override an alarm during the start-up procedure.

Sets the delay time after a run command, after which the alarm may be given.

- If Ramp Alarm=On. The start delay begins after a RUN command.
- If Ramp Alarm=Off. The start delay begins after the acceleration ramp.

	
Default:	2 s
Range:	0-3600 s

### Communication information

Modbus Instance no/ DeviceNet no:	43324
Profibus slot/index	169/228
EtherCAT index (hex)	4cfc
Fieldbus format	Long, 1=1 s
Modbus format	EInt

## Load Type [415]

In this menu you select monitor type according to the load characteristic of your application. By selecting the required monitor type, the overload and underload alarm function can be optimized according to the load characteristic.

When the application has a constant load over the whole speed range, i.e. extruder or screw compressor, the load type can be set to basic. This type uses a single value as a reference for the nominal load. This value is used for the complete speed range of the VSD. The value can be set or automatically measured. See Autoset Alarm [41A] and Normal Load [41B] about setting the nominal load reference.

The load curve mode uses an interpolated curve with 9 load values at 8 equal speed intervals. This curve is populated by a test run with a real load. This can be used with any smooth load curve including constant load.

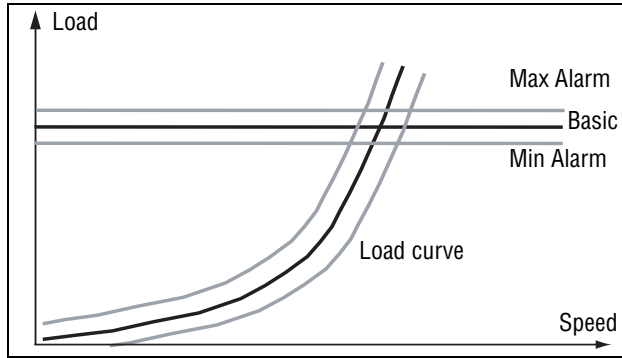

Fig. 92

<b>415 Load Type</b>		
Stp 0 Basic		
Default:	Basic	
Basic	0	Uses a fixed maximum and minimum load level over the full speed range. Can be used in situations where the torque is independent of the speed.
Load Curve	1	Uses the measured actual load characteristic of the process over the speed range.

Communication information

Modbus Instance no/ DeviceNet no:	43325
Profibus slot/index	169/229
EtherCAT index (hex)	4cfd
Fieldbus format	UInt
Modbus format	UInt

Max Alarm [416]

Max Alarm Margin [4161]

With load type Basic, [415], used the Max Alarm Margin sets the band above the Normal Load, [41B], menu that does not generate an alarm. With load type Load Curve, [415], used the Max Alarm Margin sets the band above the Load Curve, [41C], that does not generate an alarm. The Max Alarm Margin is a percentage of nominal motor torque.

<b>4161 MaxAlarmMar</b>	
Stp 15%	
Default:	15%
Range:	0–400%

Communication information

Modbus Instance no/ DeviceNet no:	43326
Profibus slot/index	169/230
EtherCAT index (hex)	4cfe
Fieldbus format	Long, 1=1%
Modbus format	EInt

Max Alarm delay [4162]

When the load level without interruption exceeds the alarm level longer than set “Max Alarm delay” time, an alarm is activate.

	
Default:	0.1 s
Range:	0-90 s

Communication information

Modbus Instance no/ DeviceNet no:	43330
Profibus slot/index	169/234
EtherCAT index (hex)	4d02
Fieldbus format	Long, 1=0.1 s
Modbus format	EInt

Max Pre Alarm [417]

Max Pre AlarmMargin [4171]

With load type Basic, [415], used the Max Pre-Alarm Margin sets the band above the Normal Load, [41B], menu that does not generate a pre-alarm. With load type Load Curve, [415], used the Max Pre-Alarm Margin sets the band above the Load Curve, [41C], that does not generate a pre-alarm. The Max Pre-Alarm Margin is a percentage of nominal motor torque.

	
Default:	10%
Range:	0–400%

Communication information

Modbus Instance no/ DeviceNet no:	43327
Profibus slot/index	169/231
EtherCAT index (hex)	4cff
Fieldbus format	Long, 1=0.1%
Modbus format	EInt

Max Pre Alarm delay [4172]

When the load level without interruption exceeds the alarm level longer than set “Max PreAlarm delay” time, a warning is activated.

	
Default:	0.1 s
Range:	0–90 s

Communication information

Modbus Instance no/ DeviceNet no:	43331
Profibus slot/index	169/235
EtherCAT index (hex)	4d03

Fieldbus format	Long, 1=0.1 s
Modbus format	EInt

### Min Pre Alarm [418]

#### Min Pre Alarm Margin [4181]

With load type Basic, [415], used the Min Pre-Alarm Margin sets the band under the Normal Load, [41B], menu that does not generate a pre-alarm. With load type Load Curve, [415], used the Min Pre-Alarm Margin sets the band under the Load Curve, [41C], that does not generate a pre-alarm. The Min Pre-Alarm Margin is a percentage of nominal motor torque.

	
Default:	10%
Range:	0-400%

#### Communication information

Modbus Instance no/ DeviceNet no:	43328
Profibus slot/index	169/232
EtherCAT index (hex)	4d00
Fieldbus format	Long, 1=1%
Modbus format	EInt

#### Min Pre Alarm Response delay [4182]

When the load level without interruption is below the alarm level longer than set "Min PreAlarm delay" time, a warning is activated.

	
Default:	0.1 s
Range:	0-90 s

#### Communication information

Modbus Instance no/ DeviceNet no:	43332
Profibus slot/index	169/236
EtherCAT index (hex)	4d04
Fieldbus format	Long, 1=0.1 s
Modbus format	EInt

### Min Alarm [419]

#### Min Alarm Margin [4191]

With load type Basic, [415], used the Min Alarm Margin sets the band under the Normal Load, [41B], menu that does not generate an alarm. With load type Load Curve, [415], used the Min Alarm Margin sets the band under the Load Curve, [41C], that does not generate an alarm. The Max Alarm Margin is a percentage of nominal motor torque.

	
--	--

Default:	15%
Range:	0-400%

Communication information

Modbus Instance no/ DeviceNet no:	43329
Profibus slot/index	169/233
EtherCAT index (hex)	4d01
Fieldbus format	Long, 1=1%
Modbus format	EInt

Min Alarm Response delay [4192]

When the load level without interruption is below the alarm level longer than set “Min Alarm delay” time, an alarm is activated.

	
Default:	0.1 s
Range:	0-90 s

Communication information

Modbus Instance no/ DeviceNet no:	43333
Profibus slot/index	169/237
EtherCAT index (hex)	4d05
Fieldbus format	Long, 1=0.1 s
Modbus format	EInt

Autoset Alarm [41A]

The Autoset Alarm function can measure the nominal load that is used as reference for the alarm levels. If the selected Load Type [415] is Basic it copies the load the motor is running with to the menu Normal Load [41B]. The motor must run on the speed that generates the load that needs to be recorded. If the selected Load Type [415] is Load Curve it performs a test-run and populates the Load Curve [41C] with the found load values.

**Warning** When autoset does a test run the motor and application/machine will ramp up to maximum speed.

**Note** The motor must be running for the Autoset Alarm function to succeed. A not running motor generates a “Failed!” message.

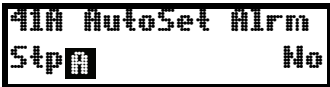
	
Default:	No
No	0
Yes	1

Communication information

Modbus Instance no/ DeviceNet no:	43334
Profibus slot/index	169/238
EtherCAT index (hex)	4d06

Fieldbus format	UInt
Modbus format	UInt

The default set levels for the (pre)alarms are:

Overload	Max Alarm	menu [4161] + [41B]
	Max Pre Alarm	menu [4171] + [41B]
Underload	Min Pre Alarm	menu [41B] - [4181]
	Min Alarm	menu [41B] - [4191]

These default set levels can be manually changed in menus [416] to [419]. After execution the message “Autoset OK!” is displayed for 1s and the selection reverts to “No”.

### Normal Load [41B]

Set the level of the normal load. The alarm or pre alarm will be activated when the load is above/under normal load ± margin.

Default:	100%
Range:	0-400% of max torque

**Note** 100% Torque means:  $I_{NOM} = I_{MOT}$ . The maximum depends on the motor current and VSD max current settings, but the absolute maximum adjustment is 400%.

#### Communication information

Modbus Instance no/ DeviceNet no:	43335
Profibus slot/index	169/239
EtherCAT index (hex)	4d07
Fieldbus format	Long, 1=1%
Modbus format	EInt

### Load Curve [41C]

The load curve function can be used with any smooth load curve. The curve can be populated with a test-run or the values can be entered or changed manually.

#### Load Curve 1-9 [41C1]-[41C9]

The measured load curve is based on 9 stored samples. The curve starts at minimum speed and ends at maximum speed, the range in between is divided into 8 equal steps. The measured values of each sample are displayed in [41C1] to [41C9] and can be adapted manually. The value of the 1st sampled value on the load curve is displayed.

Default:	100%
Range:	0–400% of max torque

Communication information

Modbus Instance no/ DeviceNet no:	43336%, 43337 rpm, 43338%, 43339 rpm, 43340%, 43341 rpm, 43342%, 43343 rpm, 43344%, 43345 rpm, 43346%, 43347 rpm, 43348%, 43349 rpm, 43350%, 43351 rpm, 43352%, 43353 rpm
Profibus slot/index	169/240, 169/242, 169/244, 169/246, 169/248, 169/250, 169/252, 169/254, 170/1
EtherCAT index (hex)	4d08%, 4d09 rpm, 4d0a%, 4d0b rpm, 4d0c%, 4d0d rpm, 4d0e%, 4d0f rpm, 4d10%, 4d11 rpm, 4d12%, 4d13 rpm, 4d14%, 4d15 rpm, 4d16%, 4d17 rpm, 4d18%, 4d19 rpm
Fieldbus format	Long
Modbus format	EInt

**Note** The speed values depend on the Min- and Max Speed values. they are read only and cannot be changed.

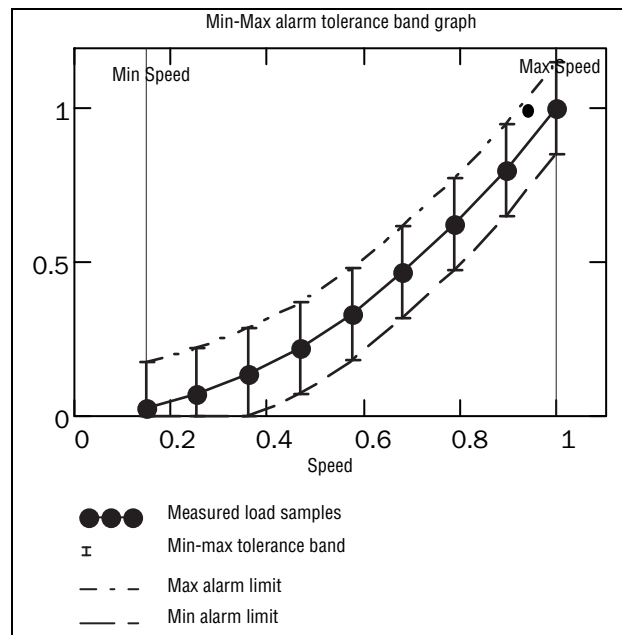

Fig. 93

11-4-2 Process Protection [420]

Submenu with settings regarding protection functions for the VSD and the motor.

Low Voltage Override [421]

If a dip in the mains supply occurs and the low voltage override function is enabled, the VSD will automatically decrease the motor speed to keep control of the application and prevent an under voltage trip until the input voltage rises again. Therefore the rotating energy in the motor/load is used to keep the DC link voltage level at the override level, for as long as possible or until the motor comes to a standstill. This is dependent on the inertia of the motor/load combination and the load of the motor at the time the dip occurs, see Fig. 94.

Default:		On
Off	0	At a voltage dip the low voltage trip will protect.
On	1	At mains dip, VSD ramps down until voltage rises.



Communication information

Modbus Instance no/ DeviceNet no:	43361
Profibus slot/index	170/10
EtherCAT index (hex)	4d21
Fieldbus format	UInt
Modbus format	UInt

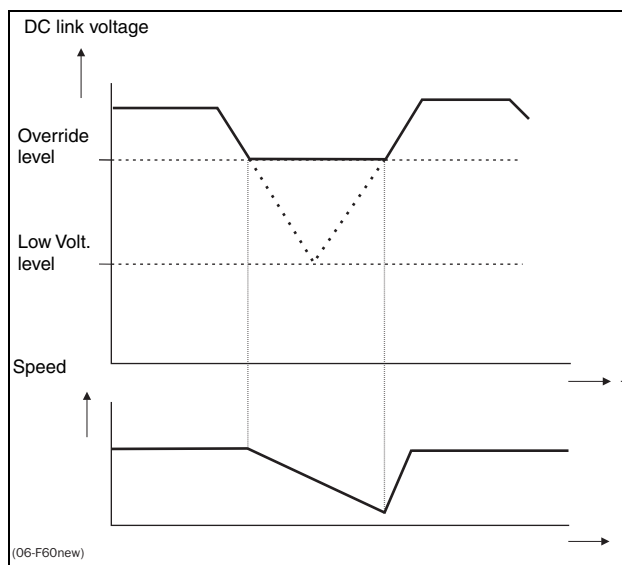

Fig. 94 Low voltage override

**Note** During the low voltage override the LED trip/limit blinks.

### Rotor locked [422]

With the rotor locked function enabled, the VSD will protect the motor and application when this is stalled whilst increasing the motor speed from standstill. This protection will coast the motor to stop and indicate a fault when the Torque Limit has been active at very low speed for more than 5 seconds.

<div style="border: 2px solid black; padding: 5px; display: inline-block;"> <b>422 Rotor locked</b>                  Stop                      Off             </div>		
Default:		Off
Off	0	No detection
On	1	VSD will trip when locked rotor is detected. Trip message "Locked Rotor".

Communication information

Modbus Instance no/ DeviceNet no:	43362
Profibus slot/index	170/11
EtherCAT index (hex)	4d22
Fieldbus format	UInt
Modbus format	UInt

### Motor lost [423]

With the motor lost function enabled, the VSD is able to detect a fault in the motor circuit: motor, motor cable, thermal relay or output filter. Motor lost will

cause a trip, and the motor will coast to standstill, when a missing motor phase is detected during a period of 5 s.

Default:		Off
Off	0	Function switched off to be used if no motor or very small motor connected.
Trip	1	VSD will trip when the motor is disconnected. Trip message "Motor Lost".

Communication information

Modbus Instance no/ DeviceNet no:	43363
Profibus slot/index	170/12
EtherCAT index (hex)	4d23
Fieldbus format	UInt
Modbus format	UInt

Overvolt control [424]

Used to switch off the overvoltage control function when only braking by brake chopper and resistor is required. The overvoltage control function, limits the braking torque so that the DC link voltage level is controlled at a high, but safe, level. This is achieved by limiting the actual deceleration rate during stopping. In case of a defect at the brake chopper or the brake resistor the VSD will trip for "Overvoltage" to avoid a fall of the load e.g. in crane applications.

**Note** Overvoltage control should not be activated if brake chopper is used.

Default:		On
On	0	Overvoltage control activated
Off	1	Overvoltage control off

Communication information

Modbus Instance no/ DeviceNet no:	43364
Profibus slot/index	170/13
EtherCAT index (hex)	4d24
Fieldbus format	UInt
Modbus format	UInt

## 11-5 I/Os and Virtual Connections [500]

Main menu with all the settings of the standard inputs and outputs of the VSD.

### 11-5-1 Analogue Inputs [510]

Submenu with all settings for the analogue inputs.

#### AnIn1 Function [511]

Sets the function for Analogue input 1. Scale and range are defined by AnIn1 Advanced settings [513].

511 AnIn1 Func Setup Process Ref		
Default:		Process Ref
Off	0	Input is not active
Max Speed	1	The input acts as an upper speed limit.
Max Torque	2	The input acts as an upper torque limit.
Process Val	3	The input value equals the actual process value (feedback) and is compared to the reference signal (set point) by the PID controller, or can be used to display and view the actual process value.
Process Ref	4	Reference value is set for control in process units, see Process Source [321] and Process Unit [322].
Min Speed	5	The input acts as a lower speed limit.

Communication information

Modbus Instance no/ DeviceNet no:	43201
Profibus slot/index	169/105
EtherCAT index (hex)	4c81
Fieldbus format	UInt
Modbus format	UInt

**Note** When AnInX Func=Off, the connected signal will still be available for Comparators [610].

#### Adding analogue inputs

If more than one analogue input is set to the same function, the values of the inputs can be added together. In the following examples we assume that Process Source [321] is set to Speed.

Example 1: Add signals with different weight (fine tuning).

Signal on AnIn1 = 10 mA

Signal on AnIn2 = 5 mA

[511] AnIn1 Function = Process Ref.

[512] AnIn1 Setup = 4-20 mA

[5134] AnIn1 Function Min = Min (0 rpm)

[5136] AnIn1 Function Max = Max (1500 rpm)

[5138] AnIn1 Operation = Add+

[514] AnIn2 Function = Process Ref.

[515] AnIn2 Setup = 4-20 mA

[5164] AnIn2 Function Min = Min (0 rpm)

[5166] AnIn2 Function Max = User defined

[5167] AnIn2 Value Max = 300 rpm

[5168] AnIn2 Operation = Add+

Calculation:

$$\text{AnIn1} = (10-4) / (20-4) \times (1500-0) + 0 = 562.5 \text{ rpm}$$

$$\text{AnIn2} = (5-4) / (20-4) \times (300-0) + 0 = 18.75 \text{ rpm}$$

The actual process reference will be:

$$+562.5 + 18.75 = 581 \text{ rpm}$$

### Analogue Input Selection via Digital Inputs:

When two different external Reference signals are used, e.g. 4-20mA signal from control centre and a 0-10 V locally mounted potentiometer, it is possible to switch between these two different analogue input signals via a Digital Input set to "AnIn Select".

AnIn1 is 4-20 mA

AnIn2 is 0-10 V

DigIn3 is controlling the AnIn selection; HIGH is 4-20 mA, LOW is 0-10 V

[511] AnIn1 Fc = Process Ref;  
set AnIn1 as reference signal input

[512] AnIn1 Setup = 4-20mA;  
set AnIn1 for a current reference signal

[513A] AnIn1 Enable = DigIn;  
set AnIn1 to be active when DigIn3 is HIGH

[514] AnIn2 Fc = Process Ref;  
set AnIn2 as reference signal input

[515] AnIn2 Setup = 0-10V;  
set AnIn2 for a voltage reference signal

[516A] AnIn2 Enabl = !DigIn;  
set AnIn2 to be active when DigIn3 is LOW

[523] DigIn3=AnIn;  
set DigIn3 as input for selection of AI reference

### Subtracting analogue inputs

Example 2: Subtract two signals

Signal on AnIn1 = 8 V

Signal on AnIn2 = 4 V

[511] AnIn1 Function = Process Ref.

[512] AnIn1 Setup = 0-10 V

[5134] AnIn1 Function Min = Min (0 rpm)

[5136] AnIn1 Function Max = Max (1500 rpm)

[5138] AnIn1 Operation = Add+

[514] AnIn2 Function = Process Ref.

[515] AnIn2 Setup = 0-10 V

[5164] AnIn2 Function Min = Min (0 rpm)

[5166] AnIn2 Function Max = Max (1500 rpm)

[5168] AnIn2 Operation = Sub-

Calculation:

$$\text{AnIn1} = (8-0) / (10-0) \times (1500-0) + 0 = 1200 \text{ rpm}$$

$$\text{AnIn2} = (4-0) / (10-0) \times (1500-0) + 0 = 600 \text{ rpm}$$

The actual process reference will be:

$$+1200 - 600 = 600 \text{ rpm}$$

### AnIn1 Setup [512]

The analogue input setup is used to configure the analogue input in accordance with the signal used that will be connected to the analogue input. With this selection the input can be determined as current (4-20 mA) or voltage (0-10 V) controlled input. Other selections are available for using a threshold (live zero), a bipolar input function, or a user defined input range. With a bipo-

lar input reference signal, it is possible to control the motor in two directions. See Fig. 95.

**Note** The selection of voltage or current input is done with S1. When the switch is in voltage mode only the voltage menu items are selectable. With the switch in current mode only the current menu items are selectable.

		S12 AnIn1 Setup Step 4-20mA
Default:		4-20 mA
Dependent on		Setting of switch S1
4-20mA	0	The current input has a fixed threshold (Live Zero) of 4 mA and controls the full range for the input signal. See Fig. 97.
0-20mA	1	Normal full current scale configuration of the input that controls the full range for the input signal. See Fig. 96.
User mA	2	The scale of the current controlled input, that controls the full range for the input signal. Can be defined by the advanced AnIn Min and AnIn Max menus.
User Bipol mA	3	Sets the input for a bipolar current input, where the scale controls the range for the input signal. Scale can be defined in advanced menu AnIn Bipol.
0-10V	4	Normal full voltage scale configuration of the input that controls the full range for the input signal. See Fig. 96.
2-10V	5	The voltage input has a fixed threshold (Live Zero) of 2 V and controls the full range for the input signal. See Fig. 97.
User V	6	The scale of the voltage controlled input, that controls the full range for the input signal. Can be defined by the advanced AnIn Min and AnIn Max menus.
User Bipol V	7	Sets the input for a bipolar voltage input, where the scale controls the range for the input signal. Scale can be defined in advanced menu AnIn Bipol.

**Note** For bipolar function, input RunR and RunL needs to be active and Rotation, [219] must be set to "R+L".

**Note** Always check the needed set up when the setting of S1 is changed; selection will not adapt automatically.

#### Communication information

Modbus Instance no/ DeviceNet no:	43202
Profibus slot/index	169/106
EtherCAT index (hex)	4c82
Fieldbus format	UInt
Modbus format	UInt

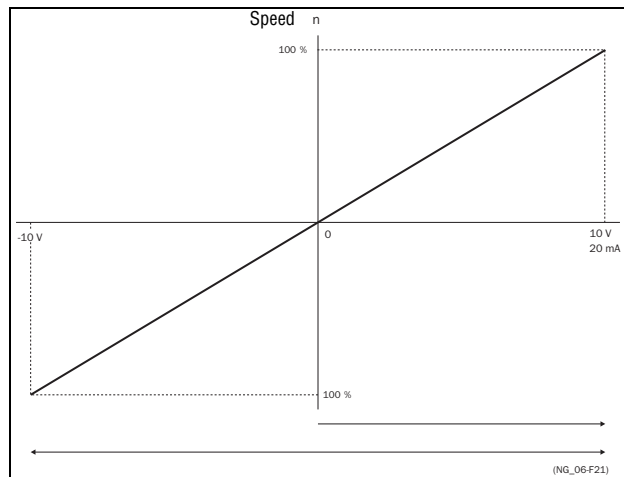

Fig. 95

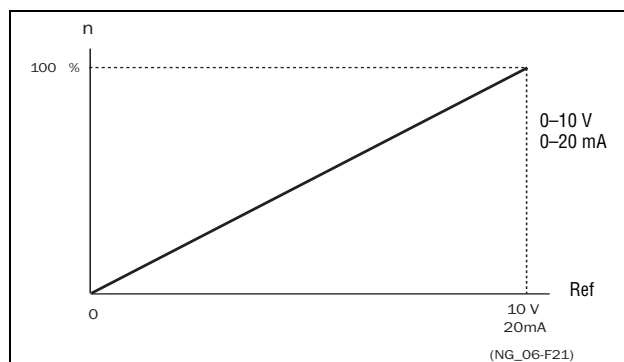

Fig. 96 Normal full-scale configuration

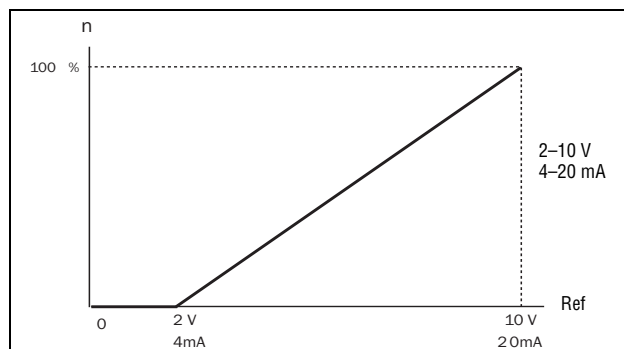
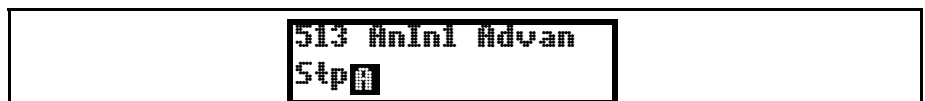

Fig. 97 2-10 V/4-20 mA (Live Zero)

### AnIn1 Advanced [513]

**Note** The different menus will automatically be set to either “mA” or “V”, based on the selection in AnIn 1 Setup [512].



**AnIn1 Min [5131]**

Parameter to set the minimum value of the external reference signal. Only visible if [512] = User mA/V.

	<b>5131 AnIn1 Min</b> <b>Stp 0V/4.00mA</b>
Default:	0 V/4.00 mA
Range:	0.00–20.00 mA 0–10.00 V

**Communication information**

Modbus Instance no/ DeviceNet no:	43203
Profibus slot/index	169/107
EtherCAT index (hex)	4c83
Fieldbus format	Long
Modbus format	EInt

**AnIn1 Max [5132]**

Parameter to set the maximum value of the external reference signal. Only visible if [512] = User mA/V.

	<b>5132 AnIn1 Max</b> <b>Stp 10.0V/20.00mA</b>
Default:	10.00 V/20.00 mA
Range:	0.00–20.00 mA 0–10.00 V

**Communication information**

Modbus Instance no/ DeviceNet no:	43204
Profibus slot/index	169/108
EtherCAT index (hex)	4c84
Fieldbus format	Long
Modbus format	EInt

**Special function: Inverted reference signal**

If the AnIn minimum value is higher than the AnIn maximum value, the input will act as an inverted reference input, see Fig. 98.

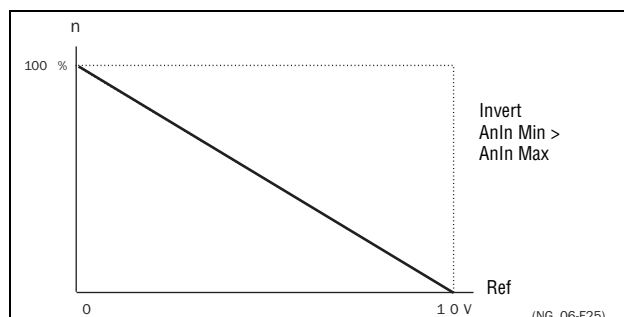



Fig. 98 Inverted reference

**AnIn1 Bipol [5133]**

This menu is automatically displayed if AnIn1 Setup is set to User Bipol mA or User Bipol V. The window will automatically show mA or V range according to

selected function. The range is set by changing the positive maximum value; the negative value is automatically adapted accordingly. Only visible if [512] = User Bipol mA/V. The inputs RunR and RunL input need to be active, and Rotation, [219], must be set to "R+L", to operate the bipolar function on the analogue input.

	
Default:	0.00–10.00 V
Range:	0.0–20.0 mA, 0.00–10.00 V

#### Communication information

Modbus Instance no/ DeviceNet no:	43205
Profibus slot/index	169/109
EtherCAT index (hex)	4c85
Fieldbus format	Long
Modbus format	EInt

#### AnIn1 Function Min [5134]

With AnIn1 Function Min the physical minimum value is scaled to selected process unit. The default scaling is dependent of the selected function of AnIn1 [511].

		
Default:	Min	
Min	0	Min value
Max	1	Max value
User-defined	2	Define user value in menu [5135]

Table 26 shows corresponding values for the min and max selections depending on the function of the analogue input [511].

Table 26

AnIn Function	Min	Max
Speed	Min Speed [341]	Max Speed [343]
Torque	0%	Max Torque [351]
Process Ref	Process Min [324]	Process Max [325]
Process Value	Process Min [324]	Process Max [325]

#### Communication information

Modbus Instance no/ DeviceNet no:	43206
Profibus slot/index	169/110
EtherCAT index (hex)	4c86
Fieldbus format	UInt
Modbus format	UInt



**AnIn1 Function Value Min [5135]**

With AnIn1 Function ValMin you define a user-defined value for the signal. Only visible when user-defined is selected in menu [5134].

	
Default:	0.000
Range:	-10000.000 – 10000.000

**Communication information**

Modbus Instance no/ DeviceNet no:	43541
Profibus slot/index	170/190
EtherCAT index (hex)	4dd5
Fieldbus format	Long, Speed 1=1 rpm Torque 1=1% Process val 1=0.001
Modbus format	EInt

**AnIn1 Function Max [5136]**

With AnIn1 Function Max the physical maximum value is scaled to selected process unit. The default scaling is dependent of the selected function of AnIn1 [511]. See Table 26.

		
Default:	Max	
Min	0	Min value
Max	1	Max value
User-defined	2	Define user value in menu [5137]

**Communication information**

Modbus Instance no/ DeviceNet no:	43207
Profibus slot/index	169/111
EtherCAT index (hex)	4c87
Fieldbus format	Long, Speed/Torque 1=1 rpm or %. Other 1= 0.001
Modbus format	EInt

**AnIn1 Function Value Max [5137]**

With AnIn1 Function VaMax you define a user-defined value for the signal. Only visible when user-defined is selected in menu [5136].

	
Default:	0.000
Range:	-10000.000 – 10000.000

## Communication information

Modbus Instance no/ DeviceNet no:	43551
Profibus slot/index	170/200
EtherCAT index (hex)	4ddf
Fieldbus format	Long, Speed 1=1 rpm Torque 1=1% Process val 1=0.001
Modbus format	EInt

**Note** With AnIn Min, AnIn Max, AnIn Function Min and AnIn Function Max settings, loss of feedback signals (e.g. voltage drop due to long sensor wiring) can be compensated to ensure an accurate process control.

## Example:

Process sensor is a sensor with the following specification:

Range:0–3 bar

Output:2–10 mA

Analogue input should be set up according to:

[512] AnIn1 Setup = User mA

[5131] AnIn1 Min = 2 mA

[5132] AnIn1 Max = 10 mA

[5134] AnIn1 Function Min = User-defined

[5135] AnIn1 VaMin = 0.000 bar

[5136] AnIn 1 Function Max = User-defined

[5137] AnIn1 VaMax = 3.000 bar

## AnIn1 Operation [5138]

Default:		Add+
Add+	0	Analogue signal is added to selected function in menu [511].
Sub-	1	Analogue signal is subtracted from selected function in menu [511].

## Communication information

Modbus Instance no/ DeviceNet no:	43208
Profibus slot/index	169/112
EtherCAT index (hex)	4c88
Fieldbus format	UInt
Modbus format	UInt

## AnIn1 Filter [5139]

If the input signal is unstable (e.g. fluctuation reference value), the filter can be used to stabilize the signal. A change of the input signal will reach 63% on AnIn1 within the set AnIn1 Filter time. After 5 times the set time, AnIn1 will have reached 100% of the input change. See Fig. 99.

Default:		0.1 s
Range:		0.001 – 10.0 s

Communication information

Modbus Instance no/ DeviceNet no:	43209
Profibus slot/index	169/113
EtherCAT index (hex)	4c89
Fieldbus format	Long, 1=0.001 s
Modbus format	EInt

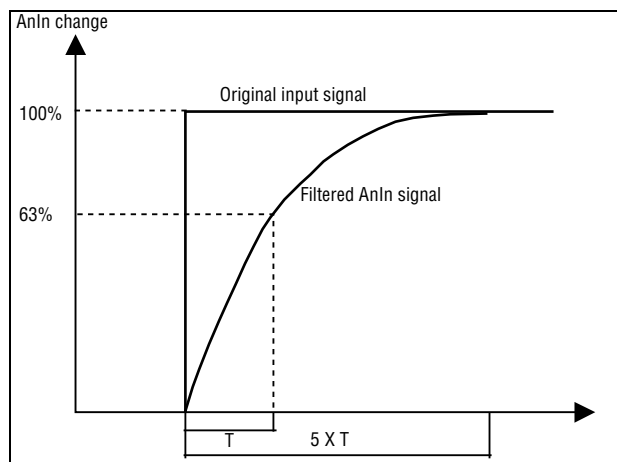

Fig. 99

AnIn1 Enable [513A]

Parameter for enable/disable analogue input selection via digital inputs (DigIn set to function AnIn Select).

<b>513A AnIn1 Enabl</b>	
<b>Stp <input checked="" type="checkbox"/> On</b>	
Default:	On
On	0 AnIn1 is always active
!DigIn	1 AnIn1 is only active if the digital input is low.
DigIn	2 AnIn1 is only active if the digital input is high.

Communication information

Modbus Instance no/ DeviceNet no:	AnIn1 43210
Profibus slot/index	AnIn1 169/114
EtherCAT index (hex)	4c8a
Fieldbus format	UInt
Modbus format	UInt

AnIn2 Function [514]

Parameter for setting the function of Analogue Input 2.

Same function as AnIn1 Func [511].

<b>514 AnIn2 Fe</b>	
<b>Stp <input type="checkbox"/> Off</b>	
Default:	Off
Selection:	Same as in menu [511]

## Communication information

Modbus Instance no/ DeviceNet no:	43211
Profibus slot/index	169/115
EtherCAT index (hex)	4c8b
Fieldbus format	UInt
Modbus format	UInt

**AnIn2 Setup [515]**

Parameter for setting the function of Analogue Input 2.

Same functions as AnIn1 Setup [512].

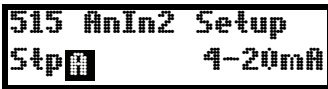
	
Default:	4 – 20 mA
Dependent on	Setting of switch S2
Selection:	Same as in menu [512].

## Communication information

Modbus Instance no/ DeviceNet no:	43212
Profibus slot/index	169/116
EtherCAT index (hex)	4c8c
Fieldbus format	UInt
Modbus format	UInt

**AnIn2 Advanced [516]**

Same functions and submenus as under AnIn1 Advanced [513].

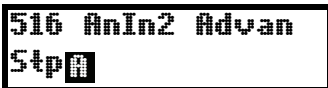
	
--	--

## Communication information

Modbus Instance no/ DeviceNet no:	43213–43220 43542 43552
Profibus slot/index	169/117–124 170/191 170/201
EtherCAT index (hex)	4c8d-4c94 4dd6 4de0
Fieldbus format	UInt
Modbus format	UInt

**AnIn3 Function [517]**

Parameter for setting the function of Analogue Input 3.

Same function as AnIn1 Func [511].

	
Default:	Off
Selection:	Same as in menu [511]

Communication information

Modbus Instance no/ DeviceNet no:	43221
Profibus slot/index	169/125
EtherCAT index (hex)	4c95
Fieldbus format	UInt
Modbus format	UInt

### AnIn3 Setup [518]

Same functions as AnIn1 Setup [512].

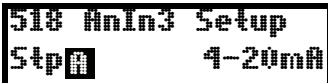
	
Default:	4–20 mA
Dependent on	Setting of switch S3
Selection:	Same as in menu [512].

Communication information

Modbus Instance no/ DeviceNet no:	43222
Profibus slot/index	169/126
EtherCAT index (hex)	4c96
Fieldbus format	UInt
Modbus format	UInt

### AnIn3 Advanced [519]

Same functions and submenus as under AnIn1 Advanced [513].

	
--	--

Communication information

Modbus Instance no/ DeviceNet no:	43223–43230 43543 43553
Profibus slot/index	169/127–169/134 170/192 170/202
EtherCAT index (hex)	4c97-4c9e 4dd7 4de1

### AnIn4 Function [51A]

Parameter for setting the function of Analogue Input 4.

Same function as AnIn1 Func [511].

	
Default:	Off
Selection:	Same as in menu [511]

Communication information

Modbus Instance no/ DeviceNet no:	43231
Profibus slot/index	169/135
EtherCAT index (hex)	4c9f
Fieldbus format	UInt
Modbus format	UInt

### AnIn4 Set-up [51B]

Same functions as AnIn1 Setup [512].

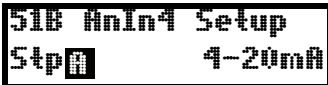
	
Default:	4-20 mA
Dependent on	Setting of switch S4
Selection:	Same as in menu [512].

Communication information

Modbus Instance no/ DeviceNet no:	43232
Profibus slot/index	169/136
EtherCAT index (hex)	4ca0
Fieldbus format	UInt
Modbus format	UInt

### AnIn4 Advanced [51C]

Same functions and submenus as under AnIn1 Advanced [513].

	
--	--

Communication information

Modbus Instance no/ DeviceNet no:	43233–43240 43544 43554
Profibus slot/index	169/137–144 170/193 170/203
EtherCAT index (hex)	4ca1-4ca8 4dd8 4de2

## 11-5-2 Digital Inputs [520]

Submenu with all the settings for the digital inputs.

**Note** Additional inputs will become available when the I/O option boards are connected.

## Digital Input 1 [521]

To select the function of the digital input.

On the standard control board there are eight digital inputs.

If the same function is programmed for more than one input that function will be activated according to “OR” logic if nothing else is stated.

		521 DigIn 1 Stop RunL
Default:		RunL
Off	0	The input is not active.
Lim Switch+	1	VSD ramps to stop and prevents rotation in “R” direction (clockwise), when the signal is low! <b>NOTE: The Lim Switch+ is active low.</b> <b>NOTE: Activated according to “AND” logic.</b>
Lim Switch -	2	VSD ramps to stop and prevents rotation in “L” direction (counter clockwise) when the signal is low! <b>NOTE: The Lim Switch- is active low.</b> <b>NOTE: Activated according to “AND” logic.</b>
Ext. Trip	3	Be aware that if there is nothing connected to the input, the VSD will trip at “External trip” immediately. <b>NOTE: The External Trip is active low.</b> <b>NOTE: Activated according to “AND” logic.</b>
Stop	4	Stop command according to the selected Stop mode in menu [33B]. <b>NOTE: The Stop command is active low.</b> <b>NOTE: Activated according to “AND” logic.</b>
Enable	5	Enable command. General start condition to run the VSD. If made low during running the output of the VSD is cut off immediately, causing the motor to coast to zero speed. <b>NOTE: If none of the digital inputs are programmed to “Enable”, the internal enable signal is active.</b> <b>NOTE: Activated according to “AND” logic.</b>
RunR	6	Run Right command. The output of the VSD will be a clockwise rotary field.
RunL	7	Run Left command. The output of the VSD will be a counter-clockwise rotary field.
Reset	9	Reset command. To reset a Trip condition and to enable the Autoreset function.
Preset Ctrl1	10	To select the Preset Reference.
Preset Ctrl2	11	To select the Preset Reference.
Preset Ctrl3	12	To select the Preset Reference.
MotPot Up	13	Increases the internal reference value according to the set AccMotPot time [333]. Has the same function as a “real” motor potentiometer, see Fig. 80.
MotPot Down	14	Decreases the internal reference value according to the set DecMotPot time [334]. See MotPot Up.
Pump1 Feedb	15	Feedback input pump1 for Pump/Fan control and informs about the status of the auxiliary connected pump/fan.
Pump2 Feedb	16	Feedback input pump 2 for Pump/Fan control and informs about the status of the auxiliary connected pump/fan.
Pump3 Feedb	17	Feedback input pump3 for Pump/Fan control and informs about the status of the auxiliary connected pump/fan.
Pump4 Feedb	18	Feedback input pump 4 for Pump/Fan control and informs about the status of the auxiliary connected pump/fan.

Pump5 Feedb	19	Feedback input pump5 for Pump/Fan control and informs about the status of the auxiliary connected pump/fan.
Pump6 Feedb	20	Feedback input pump 6 for Pump/Fan control and informs about the status of the auxiliary connected pump/fan.
Timer 1	21	Timer 1 Delay [643] will be activated on the rising edge of this signal.
Timer 2	22	Timer 2 Delay [653] will be activated on the rising edge of this signal.
Set Ctrl 1	23	Activates other parameter set. See Table 27 for selection possibilities.
Set Ctrl 2	24	Activates other parameter set. See Table 27 for selection possibilities.
Mot PreMag	25	Pre-magnetises the motor. Used for faster motor start.
Jog	26	To activate the Jog function. Gives a Run command with the set Jog speed and Direction, page 146.
Ext Mot Temp	27	Be aware that if there is nothing connected to the input, the VSD will trip at "External Motor Temp" immediately. <b>NOTE: The External Motor Temp is active low.</b>
Loc/Rem	28	Activate local mode defined in [2171] and [2172].
AnIn select	29	Activate/deactivate analogue inputs defined in [513A], [516A], [519A] and [51CA]
LC Level	30	Liquid cooling low level signal. <b>NOTE: The Liquid Cooling Level is active low.</b>
Brk Ackn	31	Brake acknowledge input for Brake Fault control. Function is activated via this selection see menu [33H]

**Note** For bipolar function, input RunR and RunL needs to be active and Rotation, [219] must be set to "R+L".

Communication information

Modbus Instance no/ DeviceNet no:	43241
Profibus slot/index	169/145
EtherCAT index (hex)	4ca9
Fieldbus format	UInt
Modbus format	UInt

Table 27

Parameter Set	Set Ctrl 1	Set Ctrl 2
A	0	0
B	1	0
C	0	1
D	1	1

**Note** To activate the parameter set selection, menu 241 must be set to DigIn.

Digital Input 2 [522] to Digital Input 8 [528]

Same function as DigIn 1 [521]. Default function for DigIn 8 is Reset. For DigIn 3 to 7 the default function is Off.

	
Default:	RunR
Selection:	Same as in menu [521]



## Communication information

Modbus Instance no/ DeviceNet no:	43241–43248
Profibus slot/index	169/146–169/152
EtherCAT index (hex)	4ca9-4cb0
Fieldbus format	UInt
Modbus format	UInt

## Additional digital inputs [529] to [52H]

Additional digital inputs with I/O option board installed, B1 DigIn 1 [529] - B3 DigIn 3 [52H]. B stands for board and 1 to 3 is the number of the board which is related to the position of the I/O option board on the option mounting plate. The functions and selections are the same as DigIn 1 [521].

## Communication information

Modbus Instance no/ DeviceNet no:	43501–43509
Profibus slot/index	170/150–170/158
EtherCAT index (hex)	4dad-4db5
Fieldbus format	Int
Modbus format	Int

## 11-5-3 Analogue Outputs [530]

Submenu with all settings for the analogue outputs. Selections can be made from application and VSD values, in order to visualize actual status. Analogue outputs can also be used as a mirror of the analogue input. Such a signal can be used as:

- a reference signal for the next VSD in a Master/Slave configuration (see Fig. 100).
- a feedback acknowledgement of the received analogue reference value.

## AnOut1 Function [531]

Sets the function for the Analogue Output 1. Scale and range are defined by AnOut1 Advanced settings [533].

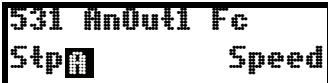
		
Default:		Speed
Process Val	0	Actual process value according to Process feedback signal.
Speed	1	Actual speed.
Torque	2	Actual torque.
Process Ref	3	Actual process reference value.
Shaft Power	4	Actual shaft power.
Frequency	5	Actual frequency.
Current	6	Actual current.
El power	7	Actual electrical power.
Output volt	8	Actual output voltage.
DC-voltage	9	Actual DC link voltage.
AnIn1	10	Mirror of received signal value on AnIn1.
AnIn2	11	Mirror of received signal value on AnIn2.
AnIn3	12	Mirror of received signal value on AnIn3.
AnIn4	13	Mirror of received signal value on AnIn4.

Speed Ref	14	Actual internal speed reference Value after ramp and V/Hz.
Torque Ref	15	Actual torque reference value (=0 in V/Hz mode)

**Note** When selections AnIn1, AnIn2 .... AnIn4 is selected, the setup of the AnOut (menu [532] or [535]) has to be set to 0-10V or 0-20mA. When the AnOut Setup is set to e.g. 4-20mA, the mirroring is not working correct.

#### Communication information

Modbus Instance no/ DeviceNet no:	43251
Profibus slot/index	169/155
EtherCAT index (hex)	4cb3
Fieldbus format	UInt
Modbus format	UInt

### AnOut 1 Setup [532]

Preset scaling and offset of the output configuration.

		
Default:		4-20mA
4-20mA	0	The current output has a fixed threshold (Live Zero) of 4 mA and controls the full range for the output signal. See Fig. 97.
0-20mA	1	Normal full current scale configuration of the output that controls the full range for the output signal. See Fig. 96.
User mA	2	The scale of the current controlled output that controls the full range for the output signal. Can be defined by the advanced AnOut Min and AnOut Max menus.
User Bipol mA	3	Sets the output for a bipolar current output, where the scale controls the range for the output signal. Scale can be defined in advanced menu AnOut Bipol.
0-10V	4	Normal full voltage scale configuration of the output that controls the full range for the output signal. See Fig. 96.
2-10V	5	The voltage output has a fixed threshold (Live Zero) of 2 V and controls the full range for the output signal. See Fig. 97.
User V	6	The scale of the voltage controlled output that controls the full range for the output signal. Can be defined by the advanced AnOut Min and AnOut Max menus.
User Bipol V	7	Sets the output for a bipolar voltage output, where the scale controls the range for the output signal. Scale can be defined in advanced menu AnOut Bipol.

#### Communication information

Modbus Instance no/ DeviceNet no:	43252
Profibus slot/index	169/156
EtherCAT index (hex)	4cb4
Fieldbus format	UInt
Modbus format	UInt

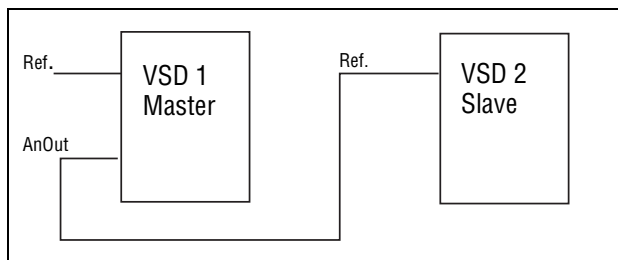

Fig. 100

### AnOut1 Advanced [533]

With the functions in the AnOut1 Advanced menu, the output can be completely defined according to the application needs. The menu will automatically be adapted to “mA” or “V”, according to the selection in AnOut1 Setup [532].



### AnOut1 Min [5331]

This parameter is automatically displayed if User mA or User V is selected in menu AnOut 1 Setup [532]. The menu will automatically adapt to current or voltage setting according to the selected setup. Only visible if [532] = User mA/V.

Default:	4 mA
Range:	0.00 – 20.00 mA, 0 – 10.00 V

#### Communication information

Modbus Instance no/ DeviceNet no:	43253
Profibus slot/index	169/157
EtherCAT index (hex)	4cb5
Fieldbus format	Long, 1=0.01
Modbus format	EInt

### AnOut1 Max [5332]

This parameter is automatically displayed if User mA or User V is selected in menu AnOut1 Setup [532]. The menu will automatically adapt to current or voltage setting according to the selected setup. Only visible if [532] = User mA/V.

Default:	20.00 mA
Range:	0.00–20.00 mA, 0–10.00 V

#### Communication information

Modbus Instance no/ DeviceNet no:	43254
Profibus slot/index	169/158
EtherCAT index (hex)	4cb6

Fieldbus format	Long, 1=0.01
Modbus format	EInt

### AnOut1 Bipol [5333]

Automatically displayed if User Bipol mA or User Bipol V is selected in menu AnOut1 Setup. The menu will automatically show mA or V range according to the selected function. The range is set by changing the positive maximum value; the negative value is automatically adapted accordingly. Only visible if [512] = User Bipol mA/V.

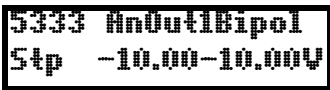
	
Default:	-10.00–10.00 V
Range:	-10.00–10.00 V, -20.0–20.0 mA

### Communication information

Modbus Instance no/ DeviceNet no:	43255
Profibus slot/index	169/159
EtherCAT index (hex)	4cb7
Fieldbus format	Long, 1=0.01
Modbus format	EInt

### AnOut1 Function Min [5334]

With AnOut1 Function Min the physical minimum value is scaled to selected presentation. The default scaling is dependent of the selected function of AnOut1 [531].

		
Default:	Min	
Min	0	Min value
Max	1	Max value
User-defined	2	Define user value in menu [5335]

Table 28 shows corresponding values for the min and max selections depending on the function of the analogue output [531].

Table 28

AnOut Function	Min Value	Max Value
Process Value	Process Min [324]	Process Max [325]
Speed	Min Speed [341]	Max Speed [343]
Torque	0%	Max Torque [351]
Process Ref	Process Min [324]	Process Max [325]
Shaft Power	0%	Motor Power [223]
Frequency	0 Hz	Motor Frequency [222]
Current	0 A	Motor Current [224]
EI Power	0 W	Motor Power [223]
Output Voltage	0 V	Motor Voltage [221]
DC voltage	0 V	1000 V
AnIn1	AnIn1 Function Min	AnIn1 Function Max
AnIn2	AnIn2 Function Min	AnIn2 Function Max
AnIn3	AnIn3 Function Min	AnIn3 Function Max
AnIn4	AnIn4 Function Min	AnIn4 Function Max

\*) Fmin is dependent on the set value in menu Minimum Speed [341].

#### Communication information

Modbus Instance no/ DeviceNet no:	43256
Profibus slot/index	169/160
EtherCAT index (hex)	4cb8
Fieldbus format	Long, 1=0.1 W, 0.1 Hz, 0.1 A, 0.1 V or 0.001
Modbus format	EInt

#### Example

Set the AnOut function for Motorfrequency to 0Hz, set AnOut functionMin [5334] to “User-defined” and AnOut1 VaMin[5335] = 0.0. This results in an analogue output signal from 0/4 mA to 20mA: 0 Hz to Fmot.

This principle is valid for all Min to Max settings.

#### AnOut1 Function Value Min [5335]

With AnOut1 Function VaMin you define a user-defined value for the signal. Only visible when user-defined is selected in menu [5334].

	<b>5335 AnOut1VaMin</b> <b>Stp</b> <b>0.000</b>
Default:	0.000
Range:	-10000.000–10000.000

#### Communication information

Modbus Instance no/ DeviceNet no:	43545
Profibus slot/index	170/194
EtherCAT index (hex)	4dd9
Fieldbus format	Long, Speed 1=1 rpm Torque 1=1% Process val 1=0.001
Modbus format	EInt

#### AnOut1 Function Max [5336]

With AnOut1 Function Min the physical minimum value is scaled to selected presentation. The default scaling is dependent on the selected function of AnOut1 [531]. See Table 28.

	<b>5336 AnOut1FCMax</b> <b>Stp</b> <b>Max</b>
Default:	Max
Min	0 Min value
Max	1 Max value
User defined	2 Define user value in menu [5337]

#### Communication information

Modbus Instance no/ DeviceNet no:	43257
Profibus slot/index	169/161
EtherCAT index (hex)	4cb9

Fieldbus format	Long, 0.001
Modbus format	EInt

**Note** It is possible to set AnOut1 up as an inverted output signal by setting AnOut1 Min > AnOut1 Max. See Fig. 98.

### AnOut1 Function Value Max [5337]

With AnOut1 Function VaMax you define a user-defined value for the signal. Only visible when user-defined is selected in menu [5334].

	<b>5337 AnOut1VaMax</b> <b>Stp</b> 0.000
Default:	0.000
Range:	-10000.000–10000.000

#### Communication information

Modbus Instance no/ DeviceNet no:	43555
Profibus slot/index	170/204
EtherCAT index (hex)	4de3
Fieldbus format	Long, Speed 1=1 rpm Torque 1=1% Process val 1=0.001
Modbus format	EInt

### AnOut2 Function [534]

Sets the function for the Analogue Output 2.

	<b>534 AnOut2 Fc</b> <b>Stp</b> Torque
Default:	Torque
Selection:	Same as in menu [531]

#### Communication information

Modbus Instance no/ DeviceNet no:	43261
Profibus slot/index	169/165
EtherCAT index (hex)	4cbd
Fieldbus format	UInt
Modbus format	UInt

### AnOut2 Setup [535]

Preset scaling and offset of the output configuration for analogue output 2.

	<b>535 AnOut2 Setup</b> <b>Stp</b> 4-20mA
Default:	4-20mA
Selection:	Same as in menu [532]

## Communication information

Modbus Instance no/ DeviceNet no:	43262
Profibus slot/index	169/166
EtherCAT index (hex)	4cbe
Fieldbus format	UInt
Modbus format	UInt

## AnOut2 Advanced [536]

Same functions and submenus as under AnOut1 Advanced [533].

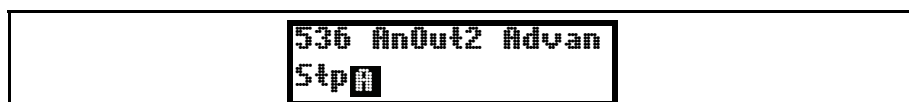

## Communication information

Modbus Instance no/ DeviceNet no:	43263–43267 43546 43556
Profibus slot/index	169/167–169/171 170/195 170/205
EtherCAT index (hex)	4cbf-4cc3 4dda 4de4

## 11-5-4 Digital Outputs [540]

Submenu with all the settings for the digital outputs.

## Digital Out 1 [541]

Sets the function for the digital output 1.

**Note** The definitions described here are valid for the active output condition.

Default:		Ready
Off	0	Output is not active and constantly low.
On	1	Output is made constantly high, i.e. for checking circuits and trouble shooting.
Run	2	Running. The VSD output is active = produces current for the motor.
Stop	3	The VSD output is not active.
0Hz	4	The output frequency=0±0.1Hz when in Run condition.
Acc/Dec	5	The speed is increasing or decreasing along the acc. ramp dec. ramp.
At Process	6	The output = Reference.
At Max spd	7	The frequency is limited by the Maximum Speed.
No Trip	8	No Trip condition active.
Trip	9	A Trip condition is active.
AutoRst Trip	10	Autoreset trip condition active.
Limit	11	A Limit condition is active.
Warning	12	A Warning condition is active.

Ready	13	The VSD is ready for operation and to accept a start command. This means that the VSD is powered up and healthy.
$T = T_{lim}$	14	The torque is limited by the torque limit function.
$I > I_{nom}$	15	The output current is higher than the motor nominal current [224], reduced according to Motor ventilation [228], see Fig. 64.
Brake	16	The output is used to control a mechanical brake.
Sgnl<Offset	17	One of the AnIn input signals is lower than 75% of the threshold level.
Alarm	18	The max or min alarm level has been reached.
Pre-Alarm	19	The max or min pre alarm level has been reached.
Max Alarm	20	The max alarm level has been reached.
Max PreAlarm	21	The max pre alarm level has been reached.
Min Alarm	22	The min alarm level has been reached.
Min PreAlarm	23	The min pre alarm Level has been reached.
LY	24	Logic output Y.
!LY	25	Logic output Y inverted.
LZ	26	Logic output Z.
!LZ	27	Logic output Z inverted.
CA 1	28	Analogue comparator 1 output.
!A1	29	Analogue comp 1 inverted output.
CA 2	30	Analogue comparator 2 output.
!A2	31	Analogue comp 2 inverted output.
CD 1	32	Digital comparator 1 output.
!D1	33	Digital comp 1 inverted output.
CD 2	34	Digital comparator 2 output.
!D2	35	Digital comp 2 inverted output.
Operation	36	Run command is active or VSD running. The signal can be used to control the mains contactor if the VSD is equipped with Standby supply option.
T1Q	37	Timer1 output
!T1Q	38	Timer1 inverted output
T2Q	39	Timer2 output
!T2Q	40	Timer2 inverted output
Sleeping	41	Sleeping function activated
Crane Deviat	42	Tripped on deviation
PumpSlave1	43	Activate pump slave 1
PumpSlave2	44	Activate pump slave 2
PumpSlave3	45	Activate pump slave 3
PumpSlave4	46	Activate pump slave 4
PumpSlave5	47	Activate pump slave 5
PumpSlave6	48	Activate pump slave 6
PumpMaster1	49	Activate pump master 1
PumpMaster2	50	Activate pump master 2
PumpMaster3	51	Activate pump master 3
PumpMaster4	52	Activate pump master 4
PumpMaster5	53	Activate pump master 5
PumpMaster6	54	Activate pump master 6
All Pumps	55	All pumps are running
Only Master	56	Only the master is running
Loc/Rem	57	Local/Rem function is active
Standby	58	Standby supply option is active
PTC Trip	59	Trip when function is active
PT100 Trip	60	Trip when function is active



Overvolt	61	Overvoltage due to high main voltage
Overvolt G	62	Overvoltage due to generation mode
Overvolt D	63	Overvoltage due to deceleration
Acc	64	Acceleration along the acc. ramp
Dec	65	Deceleration along the dec. ramp
I <sup>2</sup> t	66	I <sup>2</sup> t limit protection active
V-Limit	67	Overvoltage limit function active
C-Limit	68	Overcurrent limit function active
Overtemp	69	Over temperature warning
Low voltage	70	Low voltage warning
DigIn 1	71	Digital input 1
DigIn 2	72	Digital input 2
DigIn 3	73	Digital input 3
DigIn 4	74	Digital input 4
DigIn 5	75	Digital input 5
DigIn 6	76	Digital input 6
DigIn 7	77	Digital input 7
DigIn 8	78	Digital input 8
ManRst Trip	79	Active trip that needs to be manually reset
Com Error	80	Serial communication lost
External Fan	81	The VSD requires external cooling. Internal fans are active.
LC Pump	82	Activate liquid cooling pump
LC HE Fan	83	Activate liquid cooling heat exchanger fan
LC Level	84	Liquid cooling low level signal active
Run Right	85	Positive speed (>0.5%), i.e. forward/clockwise direction.
Run Left	86	Negative speed (≤0.5%), i.e. reverse counter clockwise direction.
Com Active	87	Fieldbus communication active.
Brk Fault	88	Tripped on brake fault (not released)
BrkNotEngage	89	Warning and continued operation (keep torque) due to Brake not engaged during stop.
Option	90	Failure occurred on in built-in option board.
CA3	91	Analog comparator 3 output
!A3	92	Analog comparator 3 inverted output
CA4	93	Analog comparator 3 output
!A4	94	Analog comparator 3 inverted output
CD3	95	Digital comparator 3 output
!D3	96	Digital comparator 3 inverted output
CD4	97	Digital comparator 4 output
!D4	98	Digital comparator 4 inverted output

## Communication information

Modbus Instance no/ DeviceNet no:	43271
Profibus slot/index	169/175
EtherCAT index (hex)	4cc7
Fieldbus format	UInt
Modbus format	UInt

## Digital Out 2 [542]

**Note** The definitions described here are valid for the active output condition.

Sets the function for the digital output 2.

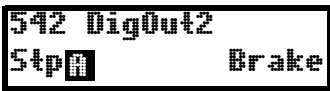
	
Default:	Brake
Selection:	Same as in menu [541]

Communication information

Modbus Instance no/ DeviceNet no:	43272
Profibus slot/index	169/176
EtherCAT index (hex)	4cc8
Fieldbus format	UInt
Modbus format	UInt

## 11-5-5 Relays [550]

Submenu with all the settings for the relay outputs. The relay mode selection makes it possible to establish a “fail safe” relay operation by using the normal closed contact to function as the normal open contact.

**Note** Additional relays will become available when I/O option boards are connected. Maximum 3 boards with 3 relays each.

### Relay 1 [551]

Sets the function for the relay output 1. Same function as digital output 1 [541] can be selected.

	
Default:	Trip
Selection:	Same as in menu [541]

Communication information

Modbus Instance no/ DeviceNet no:	43273
Profibus slot/index	169/177
EtherCAT index (hex)	4cc9
Fieldbus format	UInt
Modbus format	UInt

### Relay 2 [552]

**Note** The definitions described here are valid for the active output condition.

Sets the function for the relay output 2.

	
Default:	Run
Selection:	Same as in menu [541]

## Communication information

Modbus Instance no/ DeviceNet no:	43274
Profibus slot/index	169/178
EtherCAT index (hex)	4cca
Fieldbus format	UInt
Modbus format	UInt

## Relay 3 [553]

Sets the function for the relay output 3.

	
Default:	Off
Selection:	Same as in menu [541]

## Communication information

Modbus Instance no/ DeviceNet no:	43275
Profibus slot/index	169/179
EtherCAT index (hex)	4ccb
Fieldbus format	UInt
Modbus format	UInt

## Board Relay [554] to [55C]

These additional relays are only visible if an I/O option board is fitted in slot 1, 2, or 3. The outputs are named B1 Relay 1–3, B2 Relay 1–3 and B3 Relay 1–3. B stands for board and 1–3 is the number of the board which is related to the position of the I/O option board on the option mounting plate.

**Note** Visible only if optional board is detected or if any input/output is activated.

## Communication information

Modbus Instance no/ DeviceNet no:	43511–43519
Profibus slot/index	170/160–170/168
EtherCAT index (hex)	4db7-4dbf
Fieldbus format	UInt
Modbus format	UInt

## Relay Advanced [55D]

This function makes it possible to ensure that the relay will also be closed when the VSD is malfunctioning or powered down.

### Example

A process always requires a certain minimum flow. To control the required number of pumps by the relay mode NC, the e.g. the pumps can be controlled normally by the pump control, but are also activated when the variable speed drive is tripped or powered down.

--

## Relay 1 Mode [55D1]

		
Default:	N.O	
N.O	0	The normal open contact of the relay will be activated when the function is active.
N.C	1	The normally closed contact of the relay will act as a normal open contact. The contact will be opened when function is not active and closed when function is active.

### Communication information

Modbus Instance no/ DeviceNet no:	43276
Profibus slot/index	169/180
EtherCAT index (hex)	4ccc
Fieldbus format	UInt
Modbus format	UInt

## Relay Modes [55D2] to [55DC]

Same function as for relay 1 mode [55D1].

### Communication information

Modbus Instance no/ DeviceNet no:	43277–43278, 43521–43529
Profibus slot/index	169/181–169/182, 170/170–170/178
EtherCAT index (hex)	4ccd-4cce 4dc1-4dc9
Fieldbus format	UInt
Modbus format	UInt

## 11-5-6 Virtual Connections [560]

Functions to enable eight internal connections of comparator, timer and digital signals, without occupying physical digital in/outputs. Virtual connections are used to wireless connection of a digital output function to a digital input function. Available signals and control functions can be used to create your own specific functions.

### Example of start delay

The motor will start in RunR 10 seconds after DigIn1 gets high. DigIn1 has a time delay of 10 s.

Menu	Parameter	Setting
[521]	DigIn1	Timer 1
[561]	VIO 1 Dest	RunR
[562]	VIO 1 Source	T1Q
[641]	Timer1 Trig	DigIn 1
[642]	Timer1 Mode	Delay
[643]	Timer1 Delay	0:00:10

**Note** When a digital input and a virtual destination are set to the same function, this function will act as an OR logic function.

### Virtual Connection 1 Destination [561]

With this function the destination of the virtual connection is established. When a function can be controlled by several sources, e.g. VC destination or Digital Input, the function will be controlled in conformity with "OR logic". See DigIn for descriptions of the different selections.

	
Default:	Off
Selection:	Same selections as for Digital Input 1, menu [521].

#### Communication information

Modbus Instance no/ DeviceNet no:	43281
Profibus slot/index	169/185
EtherCAT index (hex)	4cd1
Fieldbus format	UInt
Modbus format	UInt

### Virtual Connection 1 Source [562]

With this function the source of the virtual connection is defined. See DigOut 1 for description of the different selections.

	
Default:	Off
Selection:	Same as for menu [541].

#### Communication information

Modbus Instance no/ DeviceNet no:	43282
Profibus slot/index	169/186

EtherCAT index (hex)	4cd2
Fieldbus format	UInt
Modbus format	UInt

### Virtual Connections 2-8 [563] to [56G]

Same function as virtual connection 1 [561] and [562].

Communication information for virtual connections 2-8 Destination.

Modbus Instance no/ DeviceNet no:	43283, 43285, 43287, 43289, 43291, 43293, 43295
Profibus slot/index	169/ 187, 189, 191, 193, 195, 197, 199
EtherCAT index (hex)	4cd3, 4cd5, 4cd7, 4cd9, 4cdb, 4cdd, 4cdf
Fieldbus format	UInt
Modbus format	UInt

Communication information for virtual connections 2-8 Source.

Modbus Instance no/ DeviceNet no:	43284, 43286, 43288, 43290, 43292, 43294, 43296
Profibus slot/index	169/ 188, 190, 192, 194, 196, 198, 200
EtherCAT index (hex)	4cd4, 4cd6, 4cd8, 4cda, 4cdc, 4cde, 4ce0
Fieldbus format	UInt
Modbus format	UInt

## 11-6 Logical Functions and Timers [600]

With the Comparators, Logic Functions and Timers, conditional signals can be programmed for control or signalling features. This gives you the ability to compare different signals and values in order to generate monitoring/controling features.

### 11-6-1 Comparators [610]

The comparators available make it possible to monitor different internal signals and values, and visualize via digital output or a contact, when a specific value or status is reached or established.

#### Analog comparators [611]-[614]

There are 4 analogue comparators that compare any available analogue value (including the analogue reference inputs) with two adjustable levels. The two levels available are Level HI and Level LO. there are two analogue comparator types selectable, an analogue comparator with hysteresis and an analogue window comparator.

The analogue hysteresis type compararator uses the two available levels to create a hysteresis for the comparator between setting and resetting the output. This function gives a clear diference in switching levels, which lets the process adapt until a certain action is started. With such a hysteresis, even an unstable analogue signal can be monitored without getting a nervous comparator output signal. Another feature is the possibility to get a fixed indication that a certain level has been passed. The comparator can latch by setting Level LO to a higher value than Level HI.

The analogue window comparator uses the two available levels to define the window in which the analogue value should be within for setting the comparator output.

The input analogue value of the comparator can also be selected as bipolar, i.e. treated as signed value or unipolar, i.e. treated as absolute value.

#### Digital comparators [615]

There are 4 digital comparators that compare any available digital signal.

The output signals of these comparators can be logically tied together to yield a logical output signal.

All the output signals can be programmed to the digital or relay outputs or used as a source for the virtual connections [560].

### CA1 Setup [6111]

Analaog comparator 1, parameter group.

#### Analog comparator 1, Value [6111]

Selection of the analogue value for Analogue Comparator 1 (CA1).

Analogue comparator 1 compares the selectable analogue value in menu [61111] with the constant Level HI in menu [6112] and constant Level LO in menu [6113]. If Bipolar type [6115] input signal is selected then the comparison is made with sign otherwise if unipolar is selected then comparison is made with absolute values.

For Hysteresis compararator type [6114], when the value exceeds the upper limit level high, the output signal CA1 is set high and !A1 low, see Fig. 101. When the value decreases below the lower limit, the output signal CA1 is set low and !A1 high.

The output signal can be programmed as a virtual connection source and to the digital or relay outputs.

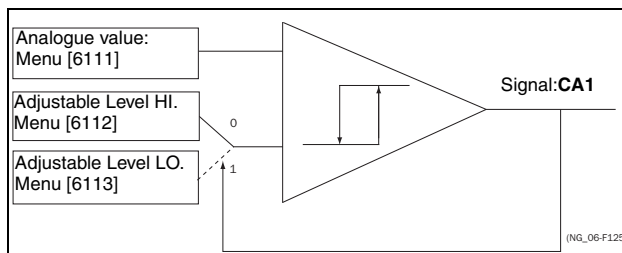

Fig. 101 Analogue Comparator type Hysteresis

For Window comparator type [6114], when the value is between the lower and upper levels, the output signal value CA1 is set high and !A1 low. When the output is outside the band of lower and upper levels, the output CA1 is set to low and !A1 high.

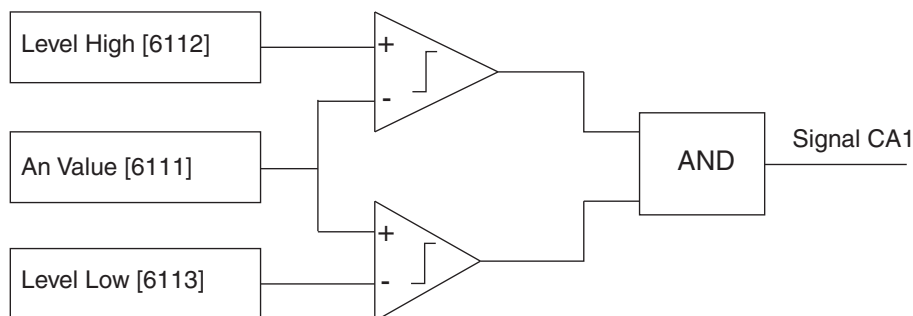

Fig. 102 Analog comparator type Window.

		6111 CA1 Value Stpm Speed
Default:		Speed
Process Val	0	Set by Process settings [321] and [322]
Speed	1	rpm
Torque	2	%
Shaft Power	3	kW
EI Power	4	kW
Current	5	A
Output Volt	6	V
Frequency	7	Hz
DC Voltage	8	V
Heatsink Tmp	9	°C
PT100_1	10	°C
PT100_2	11	°C
PT100_3	12	°C
Energy	13	kWh
Run Time	14	h
Mains Time	15	h
AnIn1	16	%
AnIn2	17	%
AnIn3	18	%
AnIn4	19	%
Process Ref	20	Set by Process settings [321] and [322]
Process Err	21	



Communication information

Modbus Instance no/ DeviceNet no:	43401
Profibus slot/index	170/50
EtherCAT index (hex)	4d49
Fieldbus format	UInt
Modbus format	UInt

Example

Create automatic RUN/STOP signal via the analogue reference signal. Analogue current reference signal, 4-20 mA, is connected to Analogue Input 1. AnIn1 Setup, menu [512] = 4-20 mA and the threshold is 4 mA. Full scale (100%) input signal on AnIn 1 = 20 mA. When the reference signal on AnIn1 increases 80% of the threshold (4 mA x 0.8 = 3.2 mA), the VSD will be set in RUN mode. When the signal on AnIn1 goes below 60% of the threshold (4 mA x 0.6 = 2.4 mA) the VSD is set to STOP mode. The output of CA1 is used as a virtual connection source that controls the virtual connection destination RUN.

Menu	Function	Setting
511	AnIn1 Function	Process reference
512	AnIn1 Set-up	4-20 mA, threshold is 4 mA
341	Min Speed	0
343	Max Speed	1500
6111	CA1 Value	AnIn1
6112	CA1 Level HI	16% (3.2mA/20mA x 100%)
6113	CA1 Level LO	12% (2.4mA/20mA x 100%)
6114	CA1 Type	Hysteresis
561	VIO 1 Dest	RunR
562	VIO 1 Source	CA1
215	Run/Stp Ctrl	Remote

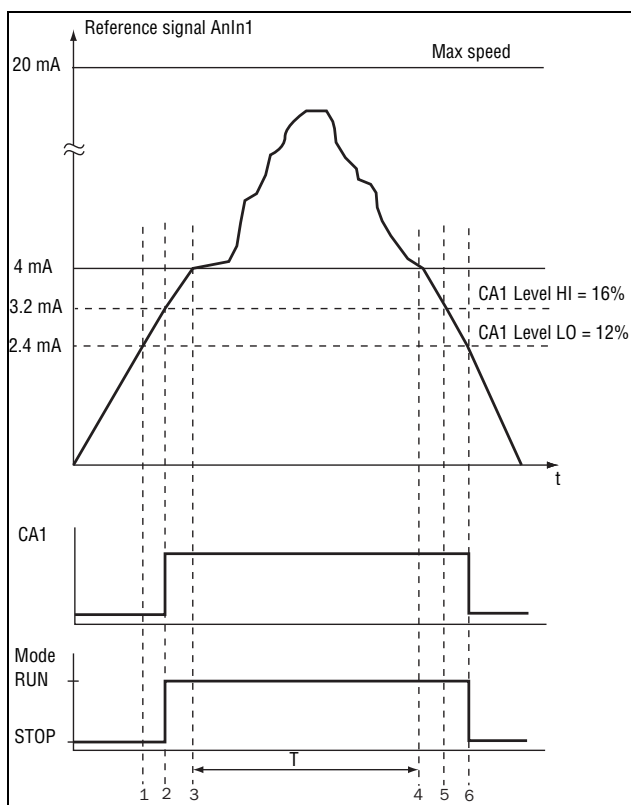

Fig. 103

No.	Description
1	The reference signal passes the Level LO value from below (positive edge), the comparator CA1 output stays low, mode=RUN.
2	The reference signal passes the Level HI value from below (positive edge), the comparator CA1 output is set high, mode=RUN.
3	The reference signal passes the threshold level of 4 mA, the motor speed will now follow the reference signal.
T	During this period the motor speed will follow the reference signal.
4	The reference signal reaches the threshold level, motor speed is 0 rpm, mode = RUN.
5	The reference signal passes the Level HI value from above (negative edge), the comparator CA1 output stays high, mode =RUN.
6	The reference signal passes the Level LO value from above (negative edge), the comparator CA1 output=STOP.

Analogue Comparator 1 Level High [6112]

Selects the analogue comparator constant high level according to the selected value in menu [6111].

The default value is 300.

<div style="border: 1px solid black; padding: 2px; display: inline-block;">                 6112 CA1 Level HI                  540 300rpm             </div>	
Default:	300 rpm
Range:	See min/max in table below.

Mode	Min	Max	Decimals
Process Val	Set by process settings [321] and [322]		3
Speed, rpm	0	Max speed	0
Torque, %	0	Max torque	0

Mode	Min	Max	Decimals
Shaft Power, kW	0	Motor P <sub>n</sub> x4	0
EI Power, kW	0	Motor P <sub>n</sub> x4	0
Current, A	0	Motor I <sub>n</sub> x4	1
Output volt, V	0	1000	1
Frequency, Hz	0	400	1
DC voltage, V	0	1250	1
Heatsink temp, °C	0	100	1
PT 100_1_2_3, °C	-100	300	1
Energy, kWh	0	1000000	0
Run time, h	0	65535	0
Mains time, h	0	65535	0
AnIn 1-4%	0	100	0
Process Ref	Set by process settings [321] and [322]		3
Process Err			

**Note** If bipolar is selected [6115] then Min value is equal to -Max in the table

Communication information

Modbus Instance no/ DeviceNet no:	43402
Profibus slot/index	170/51
EtherCAT index (hex)	4d4a
Fieldbus format	Long, 1=1 W, 0.1 A, 0.1 V, 0.1 Hz, 0.1°C, 1 kWh, 1H, 1%, 1 rpm or 0.001 via process value
Modbus format	EInt

Example

This example describes the normal use of the constant level high and low.

Menu	Function	Setting
343	Max Speed	1500
6111	CA1 Value	Speed
6112	CA1 Level HI	300 rpm
6113	CA1 Level LO	200 rpm
6114	CA1 Type	Hysteresis
561	VC1 Dest	Timer 1
562	VC1 Source	CA1

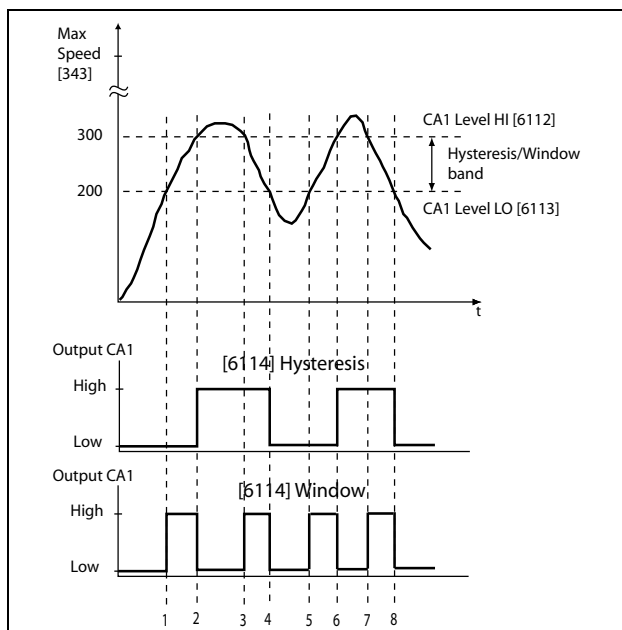

Fig. 104

Table 29 Comments to Fig. 43 regarding Hysteresis and Window selection

No.	Description	Hyster	Window
1	The reference signal passes the Level LO value from below (positive edge)	Off	On
2	The reference signal passes the Level HI value from below (positive edge)	On	Off
3	The reference signal passes the Level HI value from above (negative edge)	On	On
4	The reference signal passes the Level LO value from above (negative edge)	Off	Off
5	The reference signal passes the Level LO value from below (positive edge)	Off	On
6	The reference signal passes the Level HI value from below (positive edge)	On	Off
7	The reference signal passes the Level HI value from above (negative edge).	On	On
8	The reference signal passes the Level LO value from above (negative edge)	Off	Off

### Analogue Comparator 1 Level Low [6113]

Selects the analogue comparator constant low level according to the selected value in menu [6111].

For default value see selection table for menu [612].

<div style="border: 1px solid black; padding: 2px; display: inline-block;"> <b>6113 CM Level LO</b>                  54p <input type="checkbox"/> 200rpm             </div>	
Default:	200 rpm
Range:	Enter a value for the low level.

Communication information

Modbus Instance no/ DeviceNet no:	43403
Profibus slot/index	170/52
EtherCAT index (hex)	4d4b
Fieldbus format	Long, 1=1 W, 0.1 A, 0.1 V, 0.1 Hz, 0.1°C, 1 kWh, 1H, 1%, 1 rpm or 0.001 via process value
Modbus format	EInt

Analogue Comparator 1 Type [6114]

Selects the analogue comparator constant low level according to the selected value in menu [6111].

For default value see selection table for menu [612].

<div style="border: 2px solid black; padding: 2px; display: inline-block;"> <b>6114 CH1 Type</b>                  Stp <input type="checkbox"/> Hysteresis             </div>		
Default:		Hysteresis
Hysteresis	0	Hysteresis type comparator
Window	1	Window type comparator

Communication information

Modbus Instance no/ DeviceNet no:	43481
Profibus slot/index	170/130
EtherCAT index (hex)	4d99
Fieldbus format	UInt
Modbus format	UInt

Analogue Comparator 1 Polarity [6115]

Selects the analogue comparator constant low level according to the selected value in menu [6111].

For default value see selection table for menu [612].

<div style="border: 2px solid black; padding: 2px; display: inline-block;"> <b>6115 CH1 Polar</b>                  Stp <input type="checkbox"/> Unipolar             </div>		
Default:		Unipolar
Unipolar	0	Absolute value of [6111] used
Bipolar	1	Signed value of [6111] used

Communication information

Modbus Instance no/ DeviceNet no:	43486
Profibus slot/index	170/135
EtherCAT index (hex)	4d9e
Fieldbus format	UInt
Modbus format	UInt

Example

See next figure for different principle functionality of comparator features 6114 and 6115.

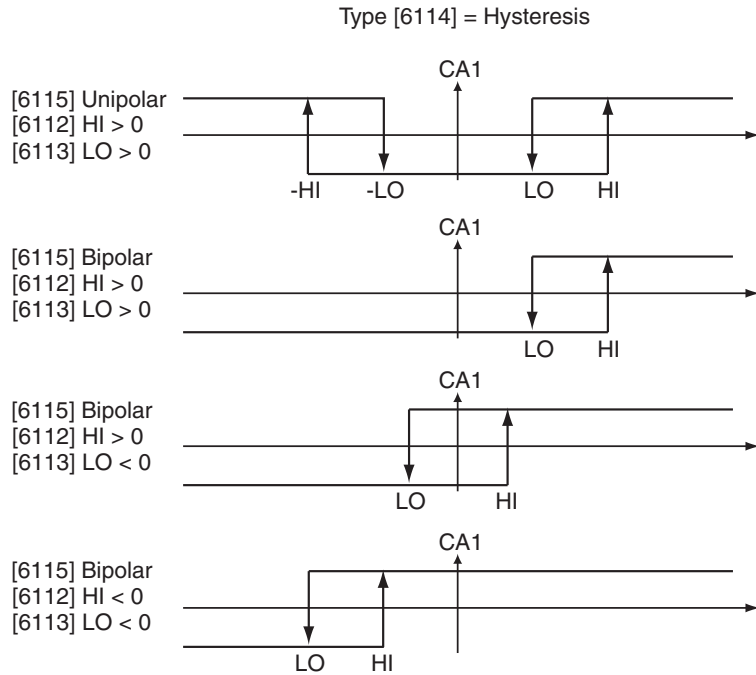

Fig. 105 Principle functionality of comparator features for “type[6115]=Hysteresis” and “Polar [6115]”.

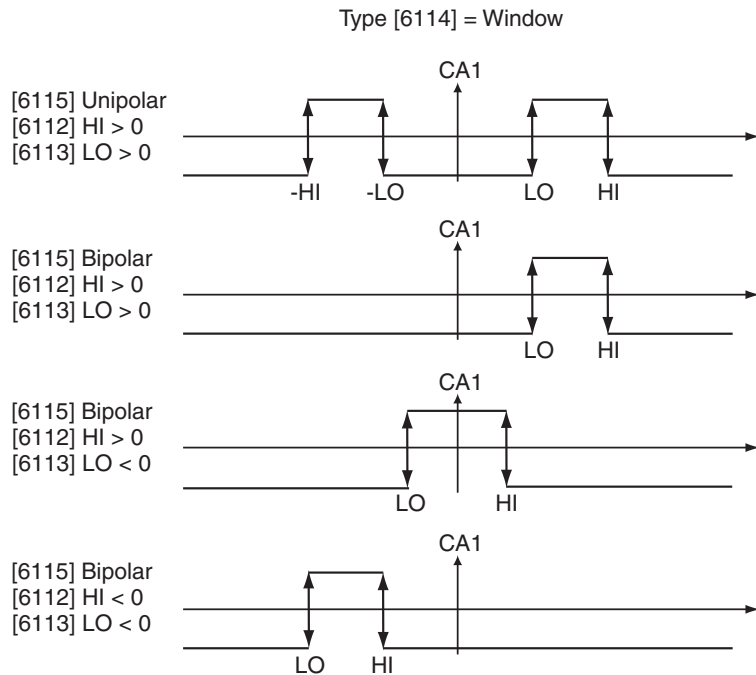

Fig. 106 Principle functionality of comparator features for “type[6115]=Window” and “Polar [6115]”.

**Note** When “unipolar” is selected, absolute value of signal is used.

**Note** When “bipolar” is selected in [6115] then:

1. Functionality is not symmetrical
2. Ranges for high/low are bipolar

### CA2 Setup [612]

Analog comparator 2, parameter group.

#### Analog comparator 2, Value [6121]

Function is identical to analogue comparator 1 value [6111].

<b>6121 CA2 Value</b> Stp  Torque	
Default:	Torque
Selections:	Same as in menu [6111]

#### Communication information

Modbus Instance no/ DeviceNet no:	43404
Profibus slot/index	170/53
EtherCAT index (hex)	4d4c
Fieldbus format	UInt
Modbus format	UInt

#### Analogue Comparator 2 Level High [6122]

Function is identical to analogue comparator 1 level high [6112].

<b>6122 CA2 Level HI</b> Stp  20%	
Default:	20%
Range:	Enter a value for the high level.

#### Communication information

Modbus Instance no/ DeviceNet no:	43405
Profibus slot/index	170/54
EtherCAT index (hex)	4d4d
Fieldbus format	Long 1=1 W, 0.1 A, 0.1 V, 0.1 Hz, 0.1°C, 1 kWh, 1H, 1%, 1 rpm or 0.001 via process value
Modbus format	EInt

#### Analogue Comparator 2 Level Low [6123]

Function is identical to analogue comparator 1 level low [6113].

<b>6123 CA2 Level LO</b> Stp  10%	
Default:	10%
Range:	Enter a value for the low level.

#### Communication information

Modbus Instance no/ DeviceNet no:	43406
Profibus slot/index	170/55
EtherCAT index (hex)	4d4e

Fieldbus format	Long, 1=1 W, 0.1 A, 0.1 V, 0.1 Hz, 0.1°C, 1 kWh, 1H, 1%, 1 rpm or 0.001 via process value
Modbus format	EInt

### Analogue Comparator 2 Type [6124]

Function is identical to analogue comparator 1 level low [6114].

<b>6124 CA2 Type</b> <b>Stp <input type="checkbox"/> Hysteresis</b>		
Default:		Hysteresis
Hysteresis	0	Hysteresis type comparator
Window	1	Window type comparator

#### Communication information

Modbus Instance no/ DeviceNet no:	43482
Profibus slot/index	170/131
EtherCAT index (hex)	4d9a
Fieldbus format	UInt
Modbus format	UInt

### Analogue Comparator 2 Polarity [6125]

Function is identical to analogue comparator 1 level low [6115].

<b>6125 CA1 Polar</b> <b>Stp <input type="checkbox"/> Unipolar</b>		
Default:		Unipolar
Unipolar	0	Absolute value of [6121] used
Bipolar	1	Signed value of [6121] used

#### Communication information

Modbus Instance no/ DeviceNet no:	43487
Profibus slot/index	170/136
EtherCAT index (hex)	4d9f
Fieldbus format	UInt
Modbus format	UInt

### CA3 Setup [613]

Analog comparator 3, parameter group.



Analog comparator 3, Value [6131]

Function is identical to analogue comparator 1 value [6111].

Default:	Process Value
Selections:	Same as in menu [6111]

Communication information

Modbus Instance no/ DeviceNet no:	43471
Profibus slot/index	170/120
EtherCAT index (hex)	4d8f
Fieldbus format	UInt
Modbus format	UInt

Analogue Comparator 3 Level High [6132]

Function is identical to analogue comparator 1 level high [6112].

Default:	300rpm
Range:	Enter a value for the high level.

Communication information

Modbus Instance no/ DeviceNet no:	43472
Profibus slot/index	170/121
EtherCAT index (hex)	4d90
Fieldbus format	Long 1=1 W, 0.1 A, 0.1 V, 0.1 Hz, 0.1°C, 1 kWh, 1H, 1%, 1 rpm or 0.001 via process value
Modbus format	EInt

Analogue Comparator 3 Level Low [6133]

Function is identical to analogue comparator 1 level low [6113].

Default:	200rpm
Range:	Enter a value for the low level.

Communication information

Modbus Instance no/ DeviceNet no:	43473
Profibus slot/index	170/122
EtherCAT index (hex)	4d91
Fieldbus format	Long, 1=1 W, 0.1 A, 0.1 V, 0.1 Hz, 0.1°C, 1 kWh, 1H, 1%, 1 rpm or 0.001 via process value
Modbus format	EInt

### Analogue Comparator 3 Type [6134]

Function is identical to analogue comparator 1 level low [6114].

<b>6134 CA3 Type Stp <input type="checkbox"/> Hysteresis</b>		
Default:		Hysteresis
Hysteresis	0	Hysteresis type comparator
Window	1	Window type comparator

#### Communication information

Modbus Instance no/ DeviceNet no:	43483
Profibus slot/index	170/132
EtherCAT index (hex)	4d9b
Fieldbus format	UInt
Modbus format	UInt

### Analogue Comparator 3 Polarity [6135]

Function is identical to analogue comparator 1 level low [6115].

<b>6135 CA3 Polar Stp <input type="checkbox"/> Unipolar</b>		
Default:		Unipolar
Unipolar	0	Absolute value of [6131] used
Bipolar	1	Signed value of [6131] used

#### Communication information

Modbus Instance no/ DeviceNet no:	43488
Profibus slot/index	170/137
EtherCAT index (hex)	4da0
Fieldbus format	UInt
Modbus format	UInt

### CA4 Setup [614]

Analog comparator 4, parameter group.

#### Analogue comparator 4, Value [6141]

Function is identical to analogue comparator 1 value [6111].

<b>6141 CA4 Value Stp <input type="checkbox"/> Process Err</b>	
Default:	Process Error
Selections:	Same as in menu [6111]

#### Communication information

Modbus Instance no/ DeviceNet no:	43474
Profibus slot/index	170/123
EtherCAT index (hex)	4d92
Fieldbus format	UInt
Modbus format	UInt

### Analogue Comparator 4 Level High [6142]

Function is identical to analogue comparator 1 level high [6112].

<b>6142 CH4 Level HI</b> <b>Stp 100rpm</b>	
Default:	100rpm
Range:	Enter a value for the high level.

#### Communication information

Modbus Instance no/ DeviceNet no:	43475
Profibus slot/index	170/124
EtherCAT index (hex)	4d93
Fieldbus format	Long 1=1 W, 0.1 A, 0.1 V, 0.1 Hz, 0.1°C, 1 kWh, 1H, 1%, 1 rpm or 0.001 via process value
Modbus format	EInt

### Analogue Comparator 4 Level Low [6143]

Function is identical to analogue comparator 1 level low [6113].

<b>6143 CH4 Level LO</b> <b>Stp -100rpm</b>	
Default:	-100rpm
Range:	Enter a value for the low level.

#### Communication information

Modbus Instance no/ DeviceNet no:	43476
Profibus slot/index	170/125
EtherCAT index (hex)	4d94
Fieldbus format	Long, 1=1 W, 0.1 A, 0.1 V, 0.1 Hz, 0.1°C, 1 kWh, 1H, 1%, 1 rpm or 0.001 via process value
Modbus format	EInt

### Analogue Comparator 4 Type [6144]

Function is identical to analogue comparator 1 level low [6114].

<b>6144 CH4 Type</b> <b>Stp Hysteresis</b>	
Default:	Hysteresis
Hysteresis	0 Hysteresis type comparator
Window	1 Window type comparator

#### Communication information

Modbus Instance no/ DeviceNet no:	43484
Profibus slot/index	170/133
EtherCAT index (hex)	4d9c
Fieldbus format	UInt
Modbus format	UInt

### Analogue Comparator 4 Polarity [6145]

Function is identical to analogue comparator 1 level low [6115].

<div style="border: 2px solid black; padding: 2px; display: inline-block;"> <b>6145 CM4 Polar</b>  <b>Stp</b>      <b>Unipolar</b> </div>		
Default:		Unipolar
Unipolar	0	Absolute value of [6141] used
Bipolar	1	Signed value of [6141] used

#### Communication information

Modbus Instance no/ DeviceNet no:	43489
Profibus slot/index	170/138
EtherCAT index (hex)	4da1
Fieldbus format	UInt
Modbus format	UInt

### Digital Comparator Setup [615]

Digital comparators, parameter group

#### Digital Comparator 1 [6151]

Selection of the input signal for digital comparator 1 (CD1).

The output signal CD1 becomes high if the selected input signal is active. See Fig. 107.

The output signal can be programmed to the digital or relay outputs or used as a source for the virtual connections [560].

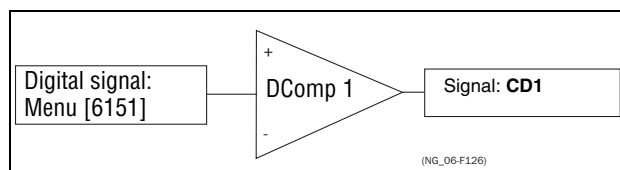

Fig. 107 Digital comparator

<div style="border: 2px solid black; padding: 2px; display: inline-block;"> <b>6151 CD1</b>  <b>Stp</b>      <b>Run</b> </div>	
Default:	Run
Selection:	Same selections as for DigOut 1 [541].

#### Communication information

Modbus Instance no/ DeviceNet no:	43407
Profibus slot/index	170/56
EtherCAT index (hex)	4d4f
Fieldbus format	UInt
Modbus format	UInt

### Digital Comparator 2 [6152]

Function is identical to digital comparator 1.

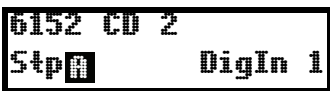
	
Default:	DigIn 1
Selection:	Same selections as for DigOut 1 [541].

Communication information

Modbus Instance no/ DeviceNet no:	43408
Profibus slot/index	170/57
EtherCAT index (hex)	4d50
Fieldbus format	UInt
Modbus format	UInt

### Digital Comparator 3 [6153]

Function is identical to digital comparator 1.

	
Default:	DigIn 1
Selection:	Same selections as for DigOut 1 [541].

Communication information

Modbus Instance no/ DeviceNet no:	43477
Profibus slot/index	170/126
EtherCAT index (hex)	4d95
Fieldbus format	UInt
Modbus format	UInt

### Digital Comparator 4 [6154]

Function is identical to digital comparator 1.

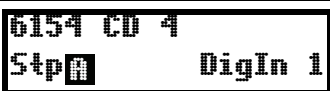
	
Default:	DigIn 1
Selection:	Same selections as for DigOut 1 [541].

Communication information

Modbus Instance no/ DeviceNet no:	43478
Profibus slot/index	170/127
EtherCAT index (hex)	4d96
Fieldbus format	UInt
Modbus format	UInt

### 11-6-2 Logic Output Y [620]

By means of an expression editor, the comparator signals can be logically combined into the Logic Y function.

The expression editor has the following features:

- The following signals can be used:  
CA1, CA2, CD1, CD2 or LZ (or LY)
- The following signals can be inverted:  
!A1, !A2, !D1, !D2, or !LZ (or !LY)
- The following logical operators are available:  
" + " : OR operator  
" & " : AND operator  
" ^ " : EXOR operator

Expressions according to the following truth table can be made:

Input		Result		
A	B	& (AND)	+ (OR)	^(EXOR)
0	0	0	0	0
0	1	0	1	1
1	0	0	1	1
1	1	1	1	0

The output signal can be programmed to the digital or relay outputs or used as a Virtual Connection Source [560].

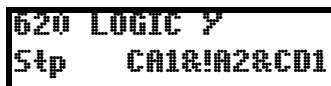

Communication information

Modbus Instance no/ DeviceNet no:	31035
Profibus slot/index	121/179
EtherCAT index (hex)	240b
Fieldbus format	Long
Modbus format	Text

The expression must be programmed by means of the menus [621] to [625].

Example:

Broken belt detection for Logic Y

This example describes the programming for a so-called “broken belt detection” for fan applications.

The comparator CA1 is set for frequency>10Hz.

The comparator !A2 is set for load < 20%.

The comparator CD1 is set for Run.

The 3 comparators are all AND-ed, given the “broken belt detection”.

In menus [621]-[625] expression entered for Logic Y is visible.

Set menu [621] to CA1

Set menu [622] to &

Set menu [623] to !A2

Set menu [624] to &

Set menu [625] to CD1

Menu [620] now holds the expression for Logic Y:

CA1&!A2&CD1

which is to be read as:

(CA1&!A2)&CD1

**Note** Set menu [624] to "." to finish the expression when only two comparators are required for Logic Y.

Y Comp 1 [621]

Selects the first comparator for the logic Y function.

		621 Y Comp 1 Stp <input type="checkbox"/> CA1
Default:		CA1
CA1	0	
!A1	1	
CA2	2	
!A2	3	
CD1	4	
!D1	5	
CD2	6	
!D2	7	
LZ/LY	8	
!LZ/!LY	9	
T1	10	
!T1	11	
T2	12	
!T2	13	
CA3	14	
!A3	15	
CA4	16	
!A4	17	
CD3	18	
!D3	19	
CD4	20	
!D4	21	

Communication information

Modbus Instance no/ DeviceNet no:	43411
Profibus slot/index	170/60
EtherCAT index (hex)	4d53
Fieldbus format	UInt
Modbus format	UInt

### Y Operator 1 [622]

Selects the first operator for the logic Y function.

		
Default:		&
&	1	&=AND
+	2	+ =OR
^	3	^ =EXOR

Communication information

Modbus Instance no/ DeviceNet no:	43412
Profibus slot/index	170/61
EtherCAT index (hex)	4d54
Fieldbus format	UInt
Modbus format	UInt

### Y Comp 2 [623]

Selects the second comparator for the logic Y function.

	
Default:	!A2
Selection:	Same as menu [621]

Communication information

Modbus Instance no/ DeviceNet no:	43413
Profibus slot/index	170/62
EtherCAT index (hex)	4d55
Fieldbus format	UInt
Modbus format	UInt

### Y Operator 2 [624]

Selects the second operator for the logic Y function.

		
Default:		&
.	0	When · (dot) is selected, the Logic Y expression is finished (when only two expressions are tied together).
&	1	&=AND



+	2	+=OR
^	3	^=EXOR

Communication information

Modbus Instance no/ DeviceNet no:	43414
Profibus slot/index	170/63
EtherCAT index (hex)	4d56
Fieldbus format	UInt
Modbus format	UInt

### Y Comp 3 [625]

Selects the third comparator for the logic Y function.

	
Default:	CD1
Selection:	Same as menu [621]

Communication information

Modbus Instance no/ DeviceNet no:	43415
Profibus slot/index	170/64
EtherCAT index (hex)	4d57
Fieldbus format	UInt
Modbus format	UInt

## 11-6-3 Logic Output Z [630]

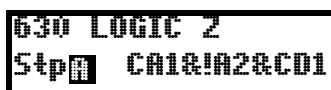

The expression must be programmed by means of the menus [631] to [635].

### Z Comp 1 [631]

Selects the first comparator for the logic Z function.

	
Default:	CA1
Selection:	Same as menu [621]

Communication information

Modbus Instance no/ DeviceNet no:	43421
Profibus slot/index	170/70
EtherCAT index (hex)	4d5d
Fieldbus format	UInt
Modbus format	UInt

### Z Operator 1 [632]

Selects the first operator for the logic Z function.

	
Default:	&
Selection:	Same as menu [622]

#### Communication information

Modbus Instance no/ DeviceNet no:	43422
Profibus slot/index	170/71
EtherCAT index (hex)	4d5e
Fieldbus format	UInt
Modbus format	UInt

### Z Comp 2 [633]

Selects the second comparator for the logic Z function.

	
Default:	!A2
Selection:	Same as menu [621]

#### Communication information

Modbus Instance no/ DeviceNet no:	43423
Profibus slot/index	170/72
EtherCAT index (hex)	4d5f
Fieldbus format	UInt
Modbus format	UInt

### Z Operator 2 [634]

Selects the second operator for the logic Z function.

	
Default:	&
Selection:	Same as menu [624]

#### Communication information

Modbus Instance no/ DeviceNet no:	43424
Profibus slot/index	170/73
EtherCAT index (hex)	4d60
Fieldbus format	UInt
Modbus format	UInt

### Z Comp 3 [635]

Selects the third comparator for the logic Z function.

	
Default:	CD1
Selection:	Same as menu [621]

#### Communication information

Modbus Instance no/ DeviceNet no:	43425
Profibus slot/index	170/74
EtherCAT index (hex)	4d61
Fieldbus format	UInt
Modbus format	UInt

### 11-6-4 Timer1 [640]

The Timer functions can be used as a delay timer or as an interval with separate On and Off times (alternate mode). In delay mode, the output signal T1Q becomes high if the set delay time is expired. See Fig. 108.

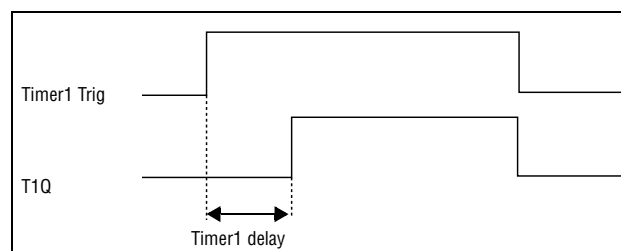

Fig. 108

In alternate mode, the output signal T1Q will switch automatically from high to low etc. according to the set interval times. See Fig. 109.

The output signal can be programmed to the digital or relay outputs used in logic functions [620] and [630], or as a virtual connection source [560].

**Note** The actual timers are common for all parameter sets. If the actual set is changed, the timer functionality [641] to [645] will change according set settings but the timer value will stay unchanged. So initialization of the timer might differ for a set change compared to normal triggering of a timer.

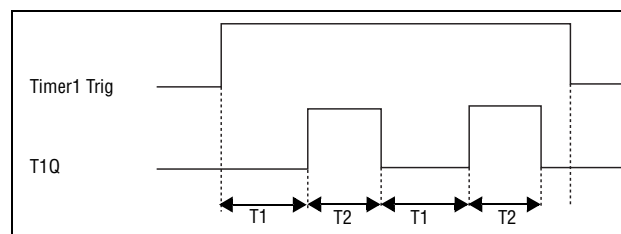

Fig. 109

### Timer 1 Trig [641]

<div style="border: 2px solid black; padding: 2px; display: inline-block;"> <b>641 Timer1 Trig</b>                  Stp <input type="checkbox"/> Off             </div>	
Default:	Off
Selection:	Same selections as Digital Output 1 menu [541].

#### Communication information

Modbus Instance no/ DeviceNet no:	43431
Profibus slot/index	170/80
EtherCAT index (hex)	4d67
Fieldbus format	UInt
Modbus format	UInt

### Timer 1 Mode [642]

<div style="border: 2px solid black; padding: 2px; display: inline-block;"> <b>642 Timer1 Mode</b>                  Stp <input type="checkbox"/> Off             </div>	
Default:	Off
Off	0
Delay	1
Alternate	2

#### Communication information

Modbus Instance no/ DeviceNet no:	43432
Profibus slot/index	170/81
EtherCAT index (hex)	4d68
Fieldbus format	UInt
Modbus format	UInt

### Timer 1 Delay [643]

This menu is only visible when timer mode is set to delay.

This menu can only be edited as in alternative 2, see section 9-5, page 75.

Timer 1 delay sets the time that will be used by the first timer after it is activated. Timer 1 can be activated by a high signal on a DigIn that is set to Timer 1 or via a virtual destination [560].

<div style="border: 2px solid black; padding: 2px; display: inline-block;"> <b>643 Timer1Delay</b>                  Stp <input type="checkbox"/> 0:00:00             </div>	
Default:	0:00:00 (hr:min:sec)
Range:	0:00:00–9:59:59

#### Communication information

Modbus Instance no/ DeviceNet no:q	43433 hours 43434 minutes 43435 seconds
Profibus slot/index	170/82, 170/83, 170/84
EtherCAT index (hex)	4d69 hours 4d6a minutes 4d6b seconds

Fieldbus format	UInt
Modbus format	UInt

### Timer 1 T1 [644]

When timer mode is set to Alternate and Timer 1 is enabled, this timer will automatically keep on switching according to the independently programmable up and down times. The Timer 1 in Alternate mode can be enabled by a digital input or via a virtual connection. See Fig. 109. Timer 1 T1 sets the up time in the alternate mode.

	
Default:	0:00:00 (hr:min:sec)
Range:	0:00:00–9:59:59

#### Communication information

Modbus Instance no/ DeviceNet no:	43436 hours 43437 minutes 43438 seconds
Profibus slot/index	170/85, 170/86, 170/87
EtherCAT index (hex)	4d6c hours 4d6d minutes 4d6e seconds
Fieldbus format	UInt
Modbus format	UInt

### Timer 1 T2 [645]

Timer 1 T2 sets the down time in the alternate mode.

	
Default:	0:00:00, hr:min:sec
Range:	0:00:00–9:59:59

#### Communication information

Modbus Instance no/ DeviceNet no:	43439 hours 43440 minutes 43441 seconds
Profibus slot/index	170/88, 170/89, 170/90
EtherCAT index (hex)	4d6f hours 4d70 minutes 4d71 seconds
Fieldbus format	UInt
Modbus format	UInt

**Note** Timer 1 T1 [644] and Timer 2 T1 [654] are only visible when Timer Mode is set to Alternate.

### Timer 1 Value [649]

Timer 1 Value shows actual value of the timer.

	
Default:	0:00:00, hr:min:sec
Range:	0:00:00–9:59:59

#### Communication information

Modbus Instance no/ DeviceNet no:	42921 hours 42922 minutes 42923 seconds
Profibus slot/index	168/80, 168/81, 168/82
EtherCAT index (hex)	4b69 hours 4b6a minutes 4b6b seconds
Fieldbus format	UInt
Modbus format	UInt

### 11-6-5 Timer2 [650]

Refer to the descriptions for Timer1.

### Timer 2 Trig [651]

	
Default:	Off
Selection:	Same selections as Digital Output 1 menu [541].

#### Communication information

Modbus Instance no/ DeviceNet no:	43451
Profibus slot/index	170/100
EtherCAT index (hex)	4d7b
Fieldbus format	UInt
Modbus format	UInt

### Timer 2 Mode [652]

	
Default:	Off
Selection:	Same as in menu [642]

#### Communication information

Modbus Instance no/ DeviceNet no:	43452
Profibus slot/index	170/101
EtherCAT index (hex)	4d7c
Fieldbus format	UInt
Modbus format	UInt

### Timer 2 Delay [653]

	
Default:	0:00:00, hr:min:sec
Range:	0:00:00–9:59:59

#### Communication information

Modbus Instance no/ DeviceNet no:	43453 hours 43454 minutes 43455 seconds
Profibus slot/index	170/102, 170/103, 170/104
EtherCAT index (hex)	4d7d hours 4d7e minutes 4d7f seconds
Fieldbus format	UInt
Modbus format	UInt

### Timer 2 T1 [654]

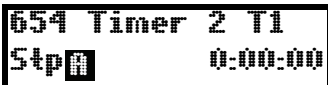
	
Default:	0:00:00, hr:min:sec
Range:	0:00:00–9:59:59

#### Communication information

Modbus Instance no/ DeviceNet no:	43456 hours 43457 minutes 43458 seconds
Profibus slot/index	170/105, 170/106, 170/107
EtherCAT index (hex)	4d80 hours 4d81 minutes 4d82 seconds
Fieldbus format	UInt
Modbus format	UInt

### Timer 2 T2 [655]

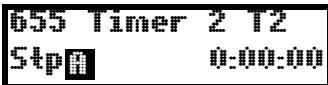
	
Default:	0:00:00, hr:min:sec
Range:	0:00:00–9:59:59

#### Communication information

Modbus Instance no/ DeviceNet no:	43459 hours 43460 minutes 43461 seconds
Profibus slot/index	170/108, 170/109, 170/110
EtherCAT index (hex)	4d83 hours 4d84 minutes 4d85 seconds

Fieldbus format	UInt
Modbus format	UInt

### Timer 2 Value [659]

Timer 2 Value shows actual value of the timer.

	
Default:	0:00:00, hr:min:sec
Range:	0:00:00–9:59:59

### Communication information

Modbus Instance no/ DeviceNet no:	42924 hours 42925 minutes 42926 seconds
Profibus slot/index	168/83, 168/84, 168/85
EtherCAT index (hex)	4b6c hours 4b6d minutes 4b6f seconds
Fieldbus format	UInt
Modbus format	UInt



## 11-7 View Operation/Status [700]

Menu with parameters for viewing all actual operational data, such as speed, torque, power, etc.

### 11-7-1 Operation [710]

#### Process Value [711]

The process value is a display function which can be programmed according to several quantities and units related to the reference value.

	<b>711 Process Val Stp</b>
Unit	Depends on selected process source, [321].
Resolution	Speed: 1 rpm, 4 digits Other units: 3 digits

#### Communication information

Modbus Instance no/ DeviceNet no:	31001
Profibus slot/index	121/145
EtherCAT index (hex)	23e9
Fieldbus format	Long, 1=0.001
Modbus format	EInt

#### Speed [712]

Displays the actual shaft speed.

	<b>712 Speed Stp                      rpm</b>
Unit:	rpm
Resolution:	1 rpm, 4 digits

#### Communication information

Modbus Instance no/ DeviceNet no:	31002
Profibus slot/index	121/146
EtherCAT index (hex)	23ea
Fieldbus format	Int, 1=1 rpm
Modbus format	Int, 1=1 rpm

## Torque [713]

Displays the actual shaft torque.

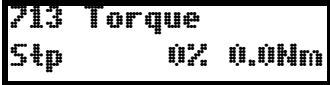
	
Unit:	Nm
Resolution:	1 Nm

### Communication information

Modbus Instance no/ DeviceNet no:	31003 Nm 31004%
Profibus slot/index	121/147
EtherCAT index (hex)	23eb Nm 23ec %
Fieldbus format	Long, 1=1%
Modbus format	EInt

## Shaft power [714]

Displays the actual shaft power.

	
Unit:	W
Resolution:	1W

### Communication information

Modbus Instance no/ DeviceNet no:	31005
Profibus slot/index	121/149
EtherCAT index (hex)	23ed
Fieldbus format	Long, 1=1W
Modbus format	EInt

## Electrical Power [715]

Displays the actual electrical output power.

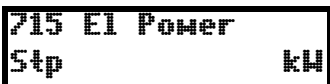
	
Unit:	kW
Resolution:	1 W

### Communication information

Modbus Instance no/ DeviceNet no:	31006
Profibus slot/index	121/150
EtherCAT index (hex)	23ee
Fieldbus format	Long, 1=1W
Modbus format	EInt

## Current [716]

Displays the actual output current.

	716 Current Stp A
Unit:	A
Resolution:	0.1 A

### Communication information

Modbus Instance no/ DeviceNet no:	31007
Profibus slot/index	121/151
EtherCAT index (hex)	23ef
Fieldbus format	Long, 1=0.1 A
Modbus format	EInt

## Output Voltage [717]

Displays the actual output voltage.

	717 Output Volt Stp V
Unit:	V
Resolution:	1 V

### Communication information

Modbus Instance no/ DeviceNet no:	31008
Profibus slot/index	121/152
EtherCAT index (hex)	23f0
Fieldbus format	Long, 1=0.1 V
Modbus format	EInt

## Frequency [718]

Displays the actual output frequency.

	718 Frequency Stp Hz
Unit:	Hz
Resolution:	0.1 Hz

### Communication information

Modbus Instance no/ DeviceNet no:	31009
Profibus slot/index	121/153
EtherCAT index (hex)	23f1
Fieldbus format	Long, 1=0.1 Hz
Modbus format	EInt

### DC Link Voltage [719]

Displays the actual DC link voltage.

	719 DC Voltage Stp V
Unit:	V
Resolution:	1 V

Communication information

Modbus Instance no/ DeviceNet no:	31010
Profibus slot/index	121/154
EtherCAT index (hex)	23f2
Fieldbus format	Long, 1=0.1 V
Modbus format	EInt

### Heatsink Temperature [71A]

Displays the actual heatsink temperature.

	71A Heatsink Tmp Stp °C
Unit:	°C
Resolution:	0.1°C

Communication information

Modbus Instance no/ DeviceNet no:	31011
Profibus slot/index	121/155
EtherCAT index (hex)	23f3
Fieldbus format	Long, 1=0.1°C
Modbus format	EInt

### PT100\_1\_2\_3 Temp [71B]

Displays the actual PT100 temperature.

	71B PT100 1,2,3 Stp °C
Unit:	°C
Resolution:	1°C

Communication information

Modbus Instance no/ DeviceNet no:	31012, 31013, 31014
Profibus slot/index	121/156, 121/157, 121/158
EtherCAT index (hex)	23f4, 23f5, 23f6
Fieldbus format	Long, 1=1°C
Modbus format	EInt

## 11-7-2 Status [720]

## VSD Status [721]

Indicates the overall status of the variable speed drive.

```

721 VSD Status
Stp 1/222/333/44

```

Fig. 110 VSD status

Display position	Status	Value
1	Parameter Set	A,B,C,D
222	Source of reference value	-Key (keyboard) -Rem (remote) -Com (Serial comm.) -Opt (option)
333	Source of Run/Stop/Reset command	-Key (keyboard) -Rem (remote) -Com (Serial comm.) -Opt (option)
44	Limit functions	-TL (Torque Limit) -SL (Speed Limit) -CL (Current Limit) -VL (Voltage Limit) - - - No limit active

### Example: "A/Key/Rem/TL"

This means:

A: Parameter Set A is active.

Key: Reference value comes from the keyboard (CP).

Rem: Run/Stop commands come from terminals 1-22.

TL: Torque Limit active.

### Communication information

Modbus Instance no/ DeviceNet no:	31015
Profibus slot/index	121/159
EtherCAT index (hex)	23f7
Fieldbus format	UInt
Modbus format	UInt

### Description of communication format

#### Integer values and bits used

Bit	Integer representation
1-0	Active Parameter set, where 0=A, 1=B, 2=C, 3=D
4-2	Source of Reference control value, where 0=Rem, 1=Key, 2=Com, 3=Option
7-5	Source of Run/Stop/Reset command, where 0=Rem, 1=Key, 2=Com, 3=Option
15-8	Active limit functions, where 0=No limit, 1=VL, 2=SL, 3=CL, 4=TL

Example: Previous example “A/Key/Rem/TL”

In bit format this is presented as:

Bit no.															
15	14	13	12	11	10	9	8	7	6	5	4	3	2	1	0
MSB															LSB
0	0	0	0	0	0	0	0	0	0	0	0	0	0	0	0
TL (4)								Rem (0)			Key (1)			A (0)	
Limit functions								Source of command			Source of control			Parameter set	

## Warning [722]

Display the actual or last warning condition. A warning occurs if the VSD is close to a trip condition but still in operation. During a warning condition the red trip LED will start to blink as long as the warning is active.

722	Warnings
Stp	warn.msg

The active warning message is displayed in menu [722].

If no warning is active the message “No Warning” is displayed.

The following warnings are possible:

Fieldbus integer value	Warning message
0	No Error
1	Motor I <sup>2</sup> t
2	PTC
3	Motor lost
4	Locked rotor
5	Ext trip
6	Mon MaxAlarm
7	Mon MinAlarm
8	Comm error
9	PT100
10	Deviation
11	Pump
12	Ext Mot Temp
13	LC Level
14	Brake
15	Option
16	Over temp
17	Over curr F
18	Over volt D
19	Over volt G
20	Over volt M
21	Over speed
22	Under voltage
23	Power fault
24	Desat
25	DCLink error
26	Int error
27	Ovolt m cut

Fieldbus integer value	Warning message
28	Over voltage
29	Not used
30	Not used
31	Not used

## Communication information

Modbus Instance no/ DeviceNet no:	31016
Profibus slot/index	121/160
EtherCAT index (hex)	23f8
Fieldbus format	Long
Modbus format	UInt

See also the Chapter SECTION 12 page 259.

## Digital Input Status [723]

Indicates the status of the digital inputs. See Fig. 111.

- 1: DigIn 1
- 2: DigIn 2
- 3: DigIn 3
- 4: DigIn 4
- 5: DigIn 5
- 6: DigIn 6
- 7: DigIn 7
- 8: DigIn 8

The positions one to eight (read from left to right) indicate the status of the associated input:

- 1: High
- 0: Low

The example in Fig. 111 indicates that DigIn 1, DigIn 3 and DigIn 6 are active at this moment.

723 DigIn Status	
Stp	1010 0100

Fig. 111 Digital input status example

## Communication information

Modbus Instance no/ DeviceNet no:	31017
Profibus slot/index	121/161
EtherCAT index (hex)	23f9
Fieldbus format	UInt, bit 0=DigIn1, bit 8=DigIn8
Modbus format	

## Digital Output Status [724]

Indicates the status of the digital outputs and relays. See Fig. 112.

RE indicate the status of the relays on position:

- 1: Relay1
- 2: Relay2
- 3: Relay3

DO indicate the status of the digital outputs on position:

1: DigOut1

2: DigOut2

The status of the associated output is shown.

1: High

0: Low

The example in Fig. 112 indicates that DigOut1 is active and Digital Out 2 is not active. Relay 1 is active, relay 2 and 3 are not active.

```

724 DigOutStatus
Stp RE 100 00 10

```

Fig. 112 Digital output status example

Communication information

Modbus Instance no/ DeviceNet no:	31018
Profibus slot/index	121/162
EtherCAT index (hex)	23fa
Fieldbus format	UInt, bit 0=DigOut1, bit 1=DigOut2
Modbus format	bit 8=Relay1 bit 9=Relay2 bit 10=Relay3

## Analogue Input Status [725]

Indicates the status of the analogue inputs 1 and 2.

```

725 AnIn 1 2
Stp -100% 65%

```

Fig. 113 Analogue input status

Communication information

Modbus Instance no/ DeviceNet no:	31019, 31020
Profibus slot/index	121/163, 121/164
EtherCAT index (hex)	23fb, 23fc
Fieldbus format	Long, 1=1%
Modbus format	EInt

The first row indicates the analogue inputs.

1: AnIn 1

2: AnIn 2

Reading downwards from the first row to the second row the status of the belonging input is shown in %:

-100% AnIn1 has a negative 100% input value

65% AnIn2 has a 65% input value

So the example in Fig. 113 indicates that both the Analogue inputs are active.

**Note** The shown percentages are absolute values based on the full range/scale of the in- our output; so related to either 0–10 V or 0–20 mA.



## Analogue Input Status [726]

Indicates the status of the analogue inputs 3 and 4.

```

726 AnIn 3 4
Stp -100% 65%

```

Fig. 114 Analogue input status

Communication information

Modbus Instance no/ DeviceNet no:	31021, 31022
Profibus slot/index	121/165, 121/166
EtherCAT index (hex)	23fd, 23fe
Fieldbus format	Long, 1=1%
Modbus format	EInt

## Analogue Output Status [727]

Indicates the status of the analogue outputs. Fig. 115. E.g. if 4-20 mA output is used, the value 20% equals to 4 mA.

```

727 AnOut 1 2
Stp -100% 65%

```

Fig. 115 Analogue output status

Communication information

Modbus Instance no/ DeviceNet no:	31023, 31024
Profibus slot/index	121/167, 121/168
EtherCAT index (hex)	23ff, 2400
Fieldbus format	Long, 1=1%
Modbus format	EInt

The first row indicates the Analogue outputs.

1: AnOut 1

2: AnOut 2

Reading downwards from the first row to the second row the status of the belonging output is shown in %:

-100% AnOut1 has a negative 100% output value

65% AnOut1 has a 65% output value

The example in Fig. 115 indicates that both the Analogue outputs are active.

**Note** The shown percentages are absolute values based on the full range/scale of the in- our output; so related to either 0–10 V or 0–20 mA.

## I/O board Status [728] - [72A]

Indicates the status for the additional I/O on option boards 1 (B1), 2 (B2) and 3 (B3).

```

728 IO B1
Stp RE000 DI10

```

## Communication information

Modbus Instance no/ DeviceNet no:	31025 - 31027
Profibus slot/index	121/170 - 172
EtherCAT index (hex)	2401-2403
Fieldbus format	UInt, bit 0=DigIn1 bit 1=DigIn2 bit 2=DigIn3
Modbus format	bit 8=Relay1 bit 9=Relay2 bit 10=Relay3

## 11-7-3 Stored values [730]

The shown values are the actual values built up over time. Values are stored at power down and updated again at power up.

## Run Time [731]

Displays the total time that the VSD has been in the Run Mode.

	
Unit:	h: m: s (hours: minutes: seconds)
Range:	0h: 0m: 0s–262143h: 59m: 59s

## Communication information

Modbus Instance no/ DeviceNet no:	31028 hours 31029 minutes 31030 seconds
Profibus slot/index	121/172 121/173 121/174
EtherCAT index (hex)	2404, 2405, 2406
Fieldbus format	UInt, 1=1h/m/s
Modbus format	UInt, 1=1h/m/s

## Reset Run Time [7311]

Reset the run time counter. The stored information will be erased and a new registration period will start.

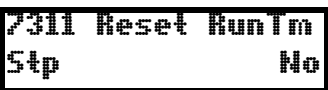
	
Default:	No
No	0
Yes	1

## Communication information

Modbus Instance no/ DeviceNet no:	7
Profibus slot/index	0/6
EtherCAT index (hex)	2007
Fieldbus format	UInt
Modbus format	UInt

**Note** After reset the setting automatically reverts to “No”.

## Mains time [732]

Displays the total time that the VSD has been connected to the mains supply. This timer cannot be reset.

	<b>732 Mains Time</b> <b>Stp</b> <b>h:m:s</b>
Unit:	h: m: s (hours: minutes: seconds)
Range:	0h: 0m: 0s–262143h: 59m: 59s

### Communication information

Modbus Instance no/ DeviceNet no:	31031 hours 31032 minutes 31033 seconds
Profibus slot/index	121/175 121/176 121/177
EtherCAT index (hex)	2407, 2408, 2409
Fieldbus format	UInt, 1=1h/m/s
Modbus format	UInt, 1=1h/m/s

**Note** At 65535 h: 59 m the counter stops. It will not revert to 0h: 0m.

## Energy [733]

Displays the total energy consumption since the last energy reset [7331] took place.

	<b>733 Energy</b> <b>Stp</b> <b>kWh</b>
Unit:	kWh
Range:	0.0–999999kWh

### Communication information

Modbus Instance no/ DeviceNet no:	31034
Profibus slot/index	121/178
EtherCAT index (hex)	240a
Fieldbus format	Long, 1=1 W
Modbus format	EInt

## Reset Energy [7331]

Resets the kWh counter. The stored information will be erased and a new registration period will start.

	<b>7331 Rst Energy</b> <b>Stp</b> <b>No</b>
Default:	No
Selection:	No, Yes

### Communication information

Modbus Instance no/ DeviceNet no:	6
Profibus slot/index	0/5
EtherCAT index (hex)	2006

Fieldbus format	UInt
Modbus format	UInt

**Note** After reset the setting automatically goes back to “No”.

## 11-8 View Trip Log [800]

Main menu with parameters for viewing all the logged trip data. In total the VSD saves the last 10 trips in the trip memory. The trip memory refreshes on the FIFO principle (First In, First Out). Every trip in the memory is logged on the time of the Run Time [731] counter. At every trip, the actual values of several parameter are stored and available for troubleshooting.

### 11-8-1 Trip Message log [810]

Display the cause of the trip and what time that it occurred. When a trip occurs the status menus are copied to the trip message log. There are nine trip message logs [810]–[890]. When the tenth trip occurs the oldest trip will disappear.

After reset of occurred trip, the trip message will be removed and menu [100] will be indicated.

	<b>8x0 Trip message</b> Stp            h:mm:ss
Unit:	h: m (hours: minutes)
Range:	0h: 0m–65355h: 59m

**810 Ext Trip**  
Stp            132:12:14

For fieldbus integer value of trip message, see message table for warnings, [722].

**Note** Bits 0–5 used for trip message value. Bits 6–15 for internal use.

Communication information

Modbus Instance no/ DeviceNet no:	31101
Profibus slot/index	121/245
EtherCAT index (hex)	244d
Fieldbus format	UInt
Modbus format	UInt

### Trip message [811]–[810]

The information from the status menus are copied to the trip message log when a trip occurs.

Trip menu	Copied from	Description
811	711	Process Value
812	712	Speed
813	712	Torque
814	714	Shaft Power
815	715	Electrical Power
816	716	Current
817	717	Output voltage
818	718	Frequency
819	719	DC Link voltage
81A	71A	Heatsink Temperature
81B	71B	PT100_1, 2, 3
81C	721	VSD Status

Trip menu	Copied from	Description
81D	723	Digital input status
81E	724	Digital output status
81F	725	Analogue input status 1-2
81G	726	Analogue input status 3-4
81H	727	Analogue output status 1-2
81I	728	I/O status option board 1
81J	729	I/O status option board 2
81K	72A	I/O status option board 3
81L	731	Run Time
81M	732	Mains Time
81N	733	Energy
81O	310	Process reference

## Communication information

Modbus Instance no/ DeviceNet no:	31102 - 31135
Profibus slot/index	121/246 - 254, 122/0 - 24
EtherCAT index (hex)	244e-246f
Fieldbus format	Depends on parameter, see respective parameter.
Modbus format	Depends on parameter, see respective parameter.

## Example:

Fig. 116 shows the third trip memory menu [830]: Over temperature trip occurred after 1396 hours and 13 minutes in Run time.

```

830 Over temp
Stp      1396h.13m

```

Fig. 116 Trip 3

## 11-8-2 Trip Messages [820] - [890]

Same information as for menu [810].

## Communication information

Modbus Instance no/ DeviceNet no:	31151–31185 31201–31235 31251–31285 31301–31335 31351–31385 31401–31435 31451–31485 31501–31535	Trip log list 2 3 4 5 6 7 8 9
Profibus slot/index	122/40–122/74 122/90–122/124 122/140–122/174 122/190–122/224 122/240–123/18 123/35 - 123/68 123/85–123/118 123/135–123/168	Trip log list 2 3 4 5 6 7 8 9

EtherCAT index (hex)	247e-24b0	Trip log list
	24b1-24e2	2
	24e3-2514	3
	2515-2546	4
	2547-2578	5
	2579-25aa	6
	25ab-25dc	7
	25dd-260e	8
		9
Fieldbus format	Depends on parameter, see respective parameter.	
Modbus format	Depends on parameter, see respective parameter.	

All nine alarm lists contain the same type of data. For example DeviceNet parameter 31101 in alarm list 1 contains the same data information as 31151 in alarm list 2. It is possible to read all parameters in alarm lists 2–9 by recalculating the DeviceNet instance number into a Profibus slot/index number. This is done in the following way:

$$\text{slot no} = \text{abs}((\text{dev instance no}-1)/255)$$

$$\text{index no} = (\text{dev instance no}-1) \text{ modulo } 255$$

$$\text{dev instance no} = \text{slot no} \times 255 + \text{index no} + 1$$

Example: We want to read out the process value out from alarm list 9. In alarm list 1 process value has the DeviceNet instance number 31102. In alarm list 9 it has DeviceNet instance no 31502 (see table 2 above). The corresponding slot/index no is then:

$$\text{slot no} = \text{abs}((31502-1)/255)=123$$

index no (modulo)= the remainder of the division above = 136, calculated as:  
 $(31502-1)-123 \times 255=136$

### 11-8-3 Reset Trip Log [8A0]

Resets the content of the 10 trip memories.

Default:	No
No	0
Yes	1

Communication information

Modbus Instance no/ DeviceNet no:	8
Profibus slot/index	0/7
EtherCAT index (hex)	2008
Fieldbus format	UInt
Modbus format	UInt

**Note** After the reset the setting goes automatically back to “NO”. The message “OK” is displayed for 2 sec.

## 11-9 System Data [900]

Main menu for viewing all the VSD system data.

### 11-9-1 VSD Data [920]

#### VSD Type [921]

Shows the VSD type according to the type number.

The options are indicated on the type plate of the VSD.

**Note** If the control board is not configured, then type type shown is SX-D6160-EF

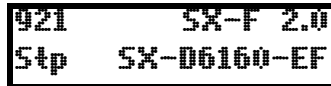

Example of type

Communication information

Modbus Instance no/ DeviceNet no:	31037
Profibus slot/index	121/181
EtherCAT index (hex)	240d
Fieldbus format	Long
Modbus format	Text

Examples:

SX-D6160-EFVSD-series suited for 690 volt mains supply, and a rated output current in normal duty of 175 A.

#### Software [922]

Shows the software version number of the VSD.

Fig. 117 gives an example of the version number.

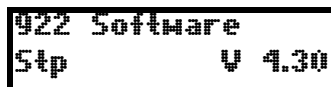

Fig. 117 Example of software version

Communication information

Modbus Instance no/ DeviceNet no:	31038 software version 31039 option version
Profibus slot/index	121/182-183
EtherCAT index (hex)	240e software version 240f option version
Fieldbus format	UInt
Modbus format	UInt

Table 30 Information for Modbus and Profibus number, software version

Bit	Description
7-0	minor



Table 30 Information for Modbus and Profibus number, software version

Bit	Description
13–8	major
15–14	release 00: V, release version 01: P, pre-release version 10: β, Beta version 11: α, Alpha version

Table 31 Information for Modbus and Profibus number, option version

Bit	Description
7–0	minor
15–8	major

V 4.30 = Version of the Software

**Note** It is important that the software version displayed in menu [920] is the same software version number as the software version number written on the title page of this instruction manual. If not, the functionality as described in this manual may differ from the functionality of the VSD.

### Unit name [923]

Option to enter a name of the unit for service use or customer identity. The function enables the user to define a name with 12 symbols. Use the Prev and Next key to move the cursor to the required position. Then use the + and - keys to scroll in the character list. Confirm the character by moving the cursor to the next position by pressing the Next key. See section User-defined Unit [323].

#### Example

Create user name USER 15.

1. When in the menu [923] press Next to move the cursor to the right most position.
2. Press the + key until the character U is displayed.
3. Press Next.
4. Then press the + key until S is displayed and confirm with Next.
5. Repeat until you have entered USER15.

<b>923 Unit Name</b> Stp
Default: No characters shown

#### Communication information

Modbus Instance no/ DeviceNet no:	42301–42312
Profibus slot/index	165/225–236
EtherCAT index (hex)	48fd-4908
Fieldbus format	UInt
Modbus format	UInt

When sending a unit name you send one character at a time starting at the right most position.



# SECTION 12

## Troubleshooting, Diagnoses and Maintenance

### 12-1 Trips, warnings and limits

In order to protect the variable speed drive the principal operating variables are continuously monitored by the system. If one of these variables exceeds the safety limit an error/warning message is displayed. In order to avoid any possibly dangerous situations, the inverter sets itself into a stop Mode called Trip and the cause of the trip is shown in the display.

Trips will always stop the VSD. Trips can be divided into normal and soft trips, depending on the setup Trip Type, see menu [250] Autoreset. Normal trips are default. For normal trips the VSD stops immediately, i.e. the motor coasts naturally to a standstill. For soft trips the VSD stops by ramping down the speed, i.e. the motor decelerates to a standstill.

#### “Normal Trip”

- The VSD stops immediately, the motor coasts to naturally to a standstill.
- The Trip relay or output is active (if selected).
- The Trip LED is on.
- The accompanying trip message is displayed.
- The “TRP” status indication is displayed (area D of the display).
- After reset command, the trip message will disappear and menu [100] will be indicated.

#### “Soft Trip”

- The VSD stops by decelerating to a standstill.

During the deceleration.

- The accompanying trip message is displayed, including an additional soft trip indicator “S” before the trip time.
- The Trip LED is blinking.
- The Warning relay or output is active (if selected).

After standstill is reached.

- The Trip LED is on.
- The Trip relay or output is active (if selected).
- The “TRP” status indication is displayed (area D of the display).
- After reset command, the trip message will disappear and menu [100] will be indicated.

Apart from the TRIP indicators there are two more indicators to show that the inverter is in an “abnormal” situation.

#### “Warning”

- The inverter is close to a trip limit.
- The Warning relay or output is active (if selected).
- The Trip LED is blinking.
- The accompanying warning message is displayed in window [722] Warning.
- One of the warning indications is displayed (area F of the display).

**“Limits”**

- The inverter is limiting torque and/or frequency to avoid a trip.
- The Limit relay or output is active (if selected).
- The Trip LED is blinking.
- One of the Limit status indications is displayed (area D of the display).

Table 32 List of trips and warnings

Trip/Warning messages	Selections	Trip (Normal/Soft)	Warning indicators (Area D)
Motor I <sup>2</sup> t	Trip/Off/Limit	Normal/Soft	I <sup>2</sup> t
PTC	Trip/Off	Normal/Soft	
Motor PTC	On	Normal	
PT100	Trip/Off	Normal/Soft	
Motor lost	Trip/Off	Normal	
Locked rotor	Trip/Off	Normal	
Ext trip	Via DigIn	Normal/Soft	
Ext Mot Temp	Via DigIn	Normal/Soft	
Mon MaxAlarm	Trip/Off/Warn	Normal/Soft	
Mon MinAlarm	Trip/Off/Warn	Normal/Soft	
Comm error	Trip/Off/Warn	Normal/Soft	
Deviation	Via Option	Normal	
Pump	Via Option	Normal	
Over temp	On	Normal	OT
Over curr F	On	Normal	
Over volt D	On	Normal	
Over volt G	On	Normal	
Over volt	On	Normal	
Over speed	On	Normal	
Under voltage	On	Normal	LV
LC Level	Trip/Off/Warm/ Via DigIn	Normal/soft	LCL
Power Fault PF ##### *	On	Normal	
Desat ### *	On	Normal	
DClink error	On	Normal	
Ovolt m cut	On	Normal	
Over voltage	Warning		VL
Safe stop	Warning		SST
Brake	Trip/Off/Warn	Normal	
OPTION	On	Normal	

- Refer to table 28 regarding which Desat or Power Fault is triggered.

## 12-2 Trip conditions, causes and remedial action

The table later on in this section must be seen as a basic aid to find the cause of a system failure and to how to solve any problems that arise. A variable speed drive is mostly just a small part of a complete VSD system. Sometimes it is difficult to determine the cause of the failure, although the variable speed drive gives a certain trip message it is not always easy to find the right cause of the failure. Good knowledge of the complete drive system is therefore necessary. Contact your supplier if you have any questions.

The VSD is designed in such a way that it tries to avoid trips by limiting torque, overvolt etc.

Failures occurring during commissioning or shortly after commissioning are most likely to be caused by incorrect settings or even bad connections.

Failures or problems occurring after a reasonable period of failure-free operation can be caused by changes in the system or in its environment (e.g. wear).

Failures that occur regularly for no obvious reasons are generally caused by Electro Magnetic Interference. Be sure that the installation fulfils the demands for installation stipulated in the EMC directives. See chapter EMC.

Sometimes the so-called "Trial and error" method is a quicker way to determine the cause of the failure. This can be done at any level, from changing settings and functions to disconnecting single control cables or replacing entire drives.

The Trip Log can be useful for determining whether certain trips occur at certain moments. The Trip Log also records the time of the trip in relation to the run time counter.

 **Warning** If it is necessary to open the VSD or any part of the system (motor cable housing, conduits, electrical panels, cabinets, etc.) to inspect or take measurements as suggested in this instruction manual, it is absolutely necessary to read and follow the safety instructions in the manual.

### 12-2-1 Technically qualified personnel

Installation, commissioning, demounting, making measurements, etc., of or at the variable speed drive may only be carried out by personnel technically qualified for the task.

### 12-2-2 Opening the variable speed drive

 **Warning** Always switch the mains voltage off if it is necessary to open the VSD and wait at least 7 minutes to allow the capacitors to discharge.

 **Warning** In case of malfunctioning always check the DC-link voltage, or wait one hour after the mains voltage has been switched off, before dismantling the VSD for repair.

The connections for the control signals and the switches are isolated from the mains voltage. Always take adequate precautions before opening the variable speed drive.

### 12-2-3 Precautions to take with a connected motor

If work must be carried out on a connected motor or on the driven machine, the mains voltage must always first be disconnected from the variable speed drive. Wait at least 7 minutes before continuing.

### 12-2-4 Autoreset Trip

If the maximum number of Trips during Autoreset has been reached, the trip message hour counter is marked with an “A”.



Fig. 118 Autoreset trip

Fig. 118 shows the 3rd trip memory menu [830]: Overvoltage G trip after the maximum Autoreset attempts took place after 345 hours, 45 minutes and 12 seconds of run time.

Table 33 Trip condition, their possible causes and remedial action

Trip condition	Possible Cause	Remedy
<b>Motor I<sup>2</sup>t</b> “I <sup>2</sup> t”	I <sup>2</sup> t value is exceeded. -Overload on the motor according to the programmed I <sup>2</sup> t settings.	-Check on mechanical overload on the motor or the machinery (bearings, gearboxes, chains, belts, etc.) -Change the Motor I <sup>2</sup> t Current setting in menu group [230]
<b>PTC</b>	Motor thermistor (PTC) exceeds maximum level. <b>Note</b> Only valid if option board PTC/PT100 is used.	-Check on mechanical overload on the motor or the machinery (bearings, gearboxes, chains, belts, etc.) -Check the motor cooling system. -Self-cooled motor at low speed, too high load. -Set PTC, menu [234] to OFF
<b>Motor PTC</b>	Motor thermistor (PTC) exceeds maximum level. <b>Note</b> Only valid if [237] is enabled.	-Check on mechanical overload on the motor or the machinery (bearings, gearboxes, chains, belts, etc.) -Check the motor cooling system. -Self-cooled motor at low speed, too high load. -Set PTC, menu [237] to OFF
<b>PT100</b>	Motor PT100 elements exceeds maximum level. <b>Note</b> Only valid if option board PTC/PT100 is used.	-Check on mechanical overload on the motor or the machinery (bearings, gearboxes, chains, belts, etc.) -Check the motor cooling system. -Self-cooled motor at low speed, too high load. -Set PT100 to OFF
<b>Motor lost</b>	Phase loss or too great imbalance on the motor phases	-Check the motor voltage on all phases. -Check for loose or poor motor cable connections -If all connections are OK, contact your supplier -Set motor lost alarm to OFF.
<b>Locked rotor</b>	Torque limit at motor standstill: -Mechanical blocking of the rotor.	-Check for mechanical problems at the motor or the machinery connected to the motor -Set locked rotor alarm to OFF.
<b>Ext trip</b>	External input (DigIn 1-8) active: - active low function on the input.	-Check the equipment that initiates the external input -Check the programming of the digital inputs DigIn 1-8
<b>Ext Mot Temp</b>	External input (DigIn 1-8) active: - active low function on the input.	-Check the equipment that initiates the external input -Check the programming of the digital inputs DigIn 1-8
<b>Mon MaxAlarm</b>	Max alarm level (overload) has been reached.	-Check the load condition of the machine -Check the monitor setting in section 11-6, page 215.
<b>Mon MinAlarm</b>	Min alarm level (underload) has been reached.	-Check the load condition of the machine -Check the monitor setting in section 11-6, page 215.
<b>Comm error</b>	Error on serial communication (option)	-Check cables and connection of the serial communication. -Check all settings with regard to the serial communication -Restart the equipment including the VSD

Table 33 Trip condition, their possible causes and remedial action

Trip condition	Possible Cause	Remedy
<b>Deviation</b>	CRANE board detecting deviation in motor operation. <b>Note</b> Only use in Crane Control.	-Check encoder signals. -Check deviation jumper on Crane option board. -Check the settings in menus [3AB] & [3AC]
<b>Pump</b>	No master pump can be selected due to error in feedback signalling. <b>Note</b> Only used in Pump Control.	-Check cables and wiring for Pump feedback signals -Check settings with regard to the pump feedback digital inputs
<b>Over temp</b>	Heatsink temperature too high: -Too high ambient temperature of the VSD -Insufficient cooling -Too high current -Blocked or stuffed fans	-Check the cooling of the VSD cabinet. -Check the functionality of the built-in fans. The fans must switch on automatically if the heatsink temperature gets too high. At power up the fans are briefly switched on. -Check VSD and motor rating -Clean fans
<b>Over curr F</b>	Motor current exceeds the peak VSD current: -Too short acceleration time. -Too high motor load -Excessive load change -Soft short-circuit between phases or phase to earth -Poor or loose motor cable connections -Too high IxR Compensation level	-Check the acceleration time settings and make them longer if necessary. -Check the motor load. -Check on bad motor cable connections -Check on bad earth cable connection -Check on water or moisture in the motor housing and cable connections. -Lower the level of IxR Compensation [352]
<b>Over volt D(acceleration)</b>	Too high DC Link voltage: -Too short deceleration time with respect to motor/machine inertia.	-Check the deceleration time settings and make them longer if necessary.
<b>Over volt G(eneration)</b>	-Too small brake resistor malfunctioning Brake chopper	-Check the dimensions of the brake resistor and the functionality of the Brake chopper (if used)
<b>Over volt (Mains)</b>	Too high DC Link voltage, due to too high mains voltage	-Check the main supply voltage
<b>Over volt M(ains) cut</b>		-Try to take away the interference cause or use other main supply lines.
<b>Over speed</b>	Motor speed measurement exceeds maximum level. 110% of max speed (all parameters sets).	-Check encoder cables, wiring and setup -Check motor data setup [22x] -Perform short ID-run
<b>Under voltage</b>	Too low DC Link voltage: -Too low or no supply voltage -Mains voltage dip due to starting other major power consuming machines on the same line.	-Make sure all three phases are properly connected and that the terminal screws are tightened. -Check that the mains supply voltage is within the limits of the VSD. -Try to use other mains supply lines if dip is caused by other machinery -Use the function low voltage override [421]
<b>LC Level</b>	Low liquid cooling level in external reservoir. External input (DigIn 1-8) active: - active low function on the input. <b>Note</b> Only valid for VSD types with Liquid Cooling option.	-Check liquid cooling -Check the equipment and wiring that initiates the external input -Check the programming of the digital inputs DigIn 1-8
<b>OPTION</b>	If and Option specific proble occurs	Check the description of the specific option

Table 33 Trip condition, their possible causes and remedial action

Trip condition	Possible Cause	Remedy
<b>Desat</b>	Failure in output stage, -desaturation of IGBTs -Hard short circuit between phases or phase to earth -Earth fault -Brake IGBT (up to SX-D4037)	-Check on bad motor cable connections
<b>Desat U+ *</b>		-Check on bad earth cable connections
<b>Desat U- *</b>		-Check on water and moisture in the motor housing and cable connections
<b>Desat V+ *</b>		-Check that the rating plate data of the motor is correctly entered.
<b>Desat V- *</b>		-Check the brake resistor, brake IGBT and wiring
<b>Desat W+ *</b>		-For size G and up, check the cables from the PEBs to the motor, that all are in correct order in parallel connection.
<b>Desat W- *</b>		
<b>Desat BCC *</b>		
<b>DC link error</b>	DC link voltage ripple exceeds maximum level	-Make sure all three phases are properly connected and that the terminal screws are tightened. -Check that the mains supply voltage is within the limits of the VSD. -Try to use other mains supply lines if dip is caused by other machinery.
<b>Power Fault</b>	One of the 10 PF (Power fault) trips below has occurred, but could not be determined.	-Check the PF errors and try to determine the cause. The trip history could be helpful.
<b>PF Fan Err *</b>	Error in fan module	-Check for clogged air inlet filters in panel door and blocking material in fan module.(SX-D4045 or UP)
<b>PF HCB Err *</b>	Error in controlled rectifier error (HCB)	-Check mains supply voltage (SX-D4030 or UP)
<b>PF Curr Err *</b>	Error in current balancing: -between different modules -between two phases within one module..	-Check motor. -Check fuses and line connections -Check the individual motor current leads with a clamp on amp meter.
<b>PF Overvolt *</b>	Error in voltage balancing, overvoltage detected in one of the power modules	-Check motor. -Check fuses and line connections.
<b>PF Comm Err *</b>	Internal communication error	Contact service
<b>PF Int Temp *</b>	Internal temperature too high	Check internal fans
<b>PF Temp Err *</b>	Malfunction in temperature sensor	Contact service
<b>PF DC Err *</b>	DC-link error and mains supply fault	-Check mains supply voltage -Check fuses and line connections.
<b>PF Sup Err *</b>	Mains supply fault	-Check mains supply voltage -Check fuses and line connections.
<b>Brake</b>	Brake tripped on brake fault (not released )or Brake not engaged during stop.	-Check Brake acknowledge signal wiring to selected digital input. -Check programming of digital input DigIn 1-8, [520]. -Check circuit breaker feeding mechanical brake circuit. -Check mechanical brake if acknowledge signal is wired from brake limit switch. -Check brake contactor. -Check settings [33C], [33D], [33E], [33F]

\* = 2...6 Module number if parallel power units (size 300–1500 A)

## 12-3 Maintenance

The variable speed drive is designed not to require any servicing or maintenance. There are however some things which must be checked regularly.

All variable speed drives have built-in fan which is speed controlled using heatsink temperature feedback. This means that the fans are only running if the VSD is running and loaded. The design of the heatsinks is such that the fan does not blow the cooling air through the interior of the VSD, but only



across the outer surface of the heatsink. However, running fans will always attract dust. Depending on the environment the fan and the heatsink will collect dust. Check this and clean the heatsink and the fans when necessary.

If variable speed drives are built into cabinets, also check and clean the dust filters of the cabinets regularly.

Check external wiring, connections and control signals. Tighten terminal screws if necessary.



## SECTION 13

### Options

The standard options available are described here briefly. Some of the options have their own instruction or installation manual. For more information please contact your supplier.

#### 13-1 Options for the control panel

Order number	Description
01-3957-00	Panel kit complete including panel
01-3957-01	Panel kit complete including blank panel

Mounting cassette, blank panel and straight RS232-cable are available as options for the control panel. These options may be useful, for example for mounting a control panel in a cabinet door.

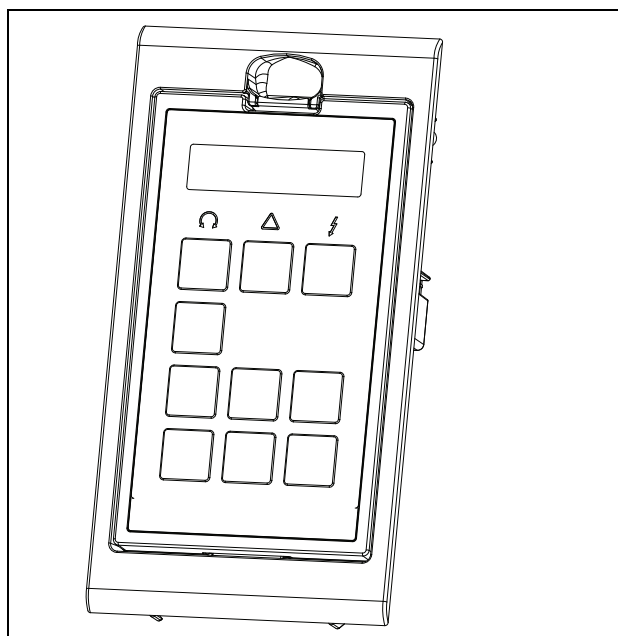

*Fig. 119 Control panel in mounting cassette*

#### 13-2 CX-Drive software

The optional software that runs on a personal computer can be used to load parameter settings from the VSD to the PC for backup and printing. Recording can be made in oscilloscope mode. Please contact OMRON sales for further information.

### 13-3 Brake chopper

All VSD sizes can be fitted with an optional built-in brake chopper. The brake resistor must be mounted outside the VSD. The choice of the resistor depends on the application switch-on duration and duty-cycle. This option can not be after mounted.

**Warning** The table gives the minimum values of the brake resistors. Do not use resistors lower than this value. The VSD can trip or even be damaged due to high braking currents.

The following formula can be used to define the power of the connected brake resistor:

$$P_{\text{resistor}} = \frac{(\text{Brake level } V_{DC})^2}{R_{\text{min}}} \times \text{ED}\%$$

Where:

$P_{\text{resistor}}$  required power of brake resistor

Brake level  $V_{DC}$  DC brake voltage level (see Table 35)

$R_{\text{min}}$  minimum allowable brake resistor (see Table 35 and Table 36)

ED% effective braking period. Defined as:

$$\text{ED}\% = \frac{\text{Active brake time at nominal braking power [s]}}{120 \text{ [s]}} \times \text{Maximum value of } 1 = \text{continuous braking}$$

Table 34 Brake Voltage levels

Supply voltage ( $V_{AC}$ ) (set in menu [21B])	Brake level ( $V_{DC}$ )
220–240	380
380–415	660
440–480	780
500–525	860
550–600	1000
660–690	1150

Table 35 Brake resistor SX 400V type

Type	$R_{\text{min}}$ [ohm] if supply 380–415 $V_{AC}$	$R_{\text{min}}$ [ohm] if supply 440–480 $V_{AC}$
SX-D40P7-EF	43	50
SX-D41P5-EF	43	50
SX-D42P2-EF	43	50
SX-D43P0-EF	43	50
SX-D44P0-EF	43	50
SX-D45P5-EF	43	50
SX-D47P5-EF	43	50
SX-D4011-EF	26	30
SX-D4015-EF	26	30
SX-D4018-EF	17	20
SX-D4022-EF	17	20

Table 35 Brake resistor SX 400V type

Type	Rmin [ohm] if supply 380–415 V <sub>AC</sub>	Rmin [ohm] if supply 440–480 V <sub>AC</sub>
SX-D4030-EF	10	12
SX-D4037-EF	10	12
SX-D4045-EF	3.8	4.4
SX-D4055-EF	3.8	4.4
SX-D4075-EF	3.8	4.4
SX-D4090-EF	3.8	4.4
SX-D4110-EF	2.7	3.1
SX-D4132-EF	2.7	3.1
SX-□4160-EF	2 x 3.8	2 x 4.4
SX-□4200-EF	2 x 3.8	2 x 4.4
SX-□4220-EF	2 x 2.7	2 x 3.1
SX-□4250-EF	2 x 2.7	2 x 3.1
SX-□4315-EF	3 x 2.7	3 x 3.1
SX-□4355-EF	3 x 2.7	3 x 3.1
SX-□4400-EF	3 x 2.7	3 x 3.1
SX-□4450-EF	4 x 2.7	4 x 3.1
SX-□4500-EF	4 x 2.7	4 x 3.1
SX-□4630-EF	6 x 2.7	6 x 3.1
SX-□4800-EF	6 x 2.7	6 x 3.1

Although the VSD will detect a failure in the brake electronics, the use of resistors with a thermal overload which will cut off the power at overload is strongly recommended.

Table 36 Brake resistors SX 690V types

Type	Rmin [ohm] if supply 500–525 V <sub>AC</sub>	Rmin [ohm] if supply 550–600 V <sub>AC</sub>	Rmin [ohm] if supply 660–690 V <sub>AC</sub>
SX-D6090-EF	4.9	5.7	6.5
SX-D6110-EF	4.9	5.7	6.5
SX-D6132-EF	4.9	5.7	6.5
SX-D6160-EF	4.9	5.7	6.5
SX-□6200-EF	2 x 4.9	2 x 5.7	2 x 6.5
SX-□6250-EF	2 x 4.9	2 x 5.7	2 x 6.5
SX-□6315-EF	2 x 4.9	2 x 5.7	2 x 6.5
SX-□6355-EF	2 x 4.9	2 x 5.7	2 x 6.5
SX-□6450-EF	3 x 4.9	3 x 5.7	3 x 6.5
SX-□6500-EF	3 x 4.9	3 x 5.7	3 x 6.5
SX-□6600-EF	4 x 4.9	4 x 5.7	4 x 6.5
SX-□6630-EF	4 x 4.9	4 x 5.7	4 x 6.5
SX-□6710-EF	6 x 4.9	6 x 5.7	6 x 6.5
SX-□6800-EF	6 x 4.9	6 x 5.7	6 x 6.5
SX-□6900-EF	6 x 4.9	6 x 5.7	6 x 6.5
SX-□61K0-EF	6 x 4.9	6 x 5.7	6 x 6.5

The brake chopper option is built-in by the manufacturer and must be specified when the VSD is ordered.

## 13-4 I/O Board

Order number	Description
01-3876-01	I/O option board 2.0

The I/O option board 2.0 provides three extra relay outputs and three extra digital inputs. The I/O Board works in combination with the Pump/Fan Control, but can also be used as a separate option. This option is described in a separate manual.

## 13-5 Encoder

Order number	Description
01-3876-03	Encoder 2.0 option board

The Encoder 2.0 option board, used for connection of feedback signal of the actual motor speed via an incremental encoder is described in a separate manual.

For SX-V type, this function is for speed read-out only or for spin start function. No speed control.

## 13-6 PTC/PT100

Order number	Description
01-3876-08	PTC/PT100 2.0 option board

The PTC/PT100 2.0 option board for connecting motor thermistors and a max of 3 PT100 elements to the VSD is described in a separate manual.

## 13-7 Crane option board

Order number	Description
590059	Crane interface board, 230 V <sub>AC</sub>
590060	Crane interface board, 24 V <sub>DC</sub>

This option is used in crane applications. The crane option board 2.0 is described in a separate manual.

## 13-8 Serial communication and fieldbus

Order number	Description
01-3876-04	RS232/485
01-3876-05	Profibus DP
01-3876-06	DeviceNet
01-3876-09	Modbus/TCP, Industrial Ethernet
01-3876-10	EtherCAT, Industrial Ethernet

For communication with the VSD there are several option boards for communication. There are different options for Fieldbus communication and one serial communication option with RS232 or RS485 interface which has galvanic isolation.

### 13-9 Standby supply board option

Order number	Description
01-3954-00	Standby power supply kit for after mounting

The standby supply board option provides the possibility of keeping the communication system up and running without having the 3-phase mains connected. One advantage is that the system can be set up without mains power. The option will also give backup for communication failure if main power is lost.

The standby supply board option is supplied with external  $\pm 10\%$  24 V<sub>DC</sub> protected by a 2 A slow acting fuse, from a double isolated transformer. The terminals X1:1 and X1:2 are voltage polarity independent. The terminals A- and B+ (on size D) are voltage polarity dependent.

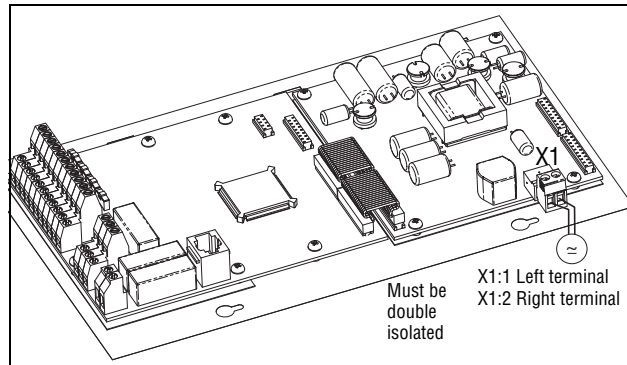

Fig. 120 Connection of standby supply option

Table 37

X1 terminal	Name	Function	Specification
1	Ext. supply 1	External, VSD main power independent, supply voltage for control and communication circuits	24 V <sub>DC</sub> $\pm 10\%$ Double isolated
2	Ext. supply 2		

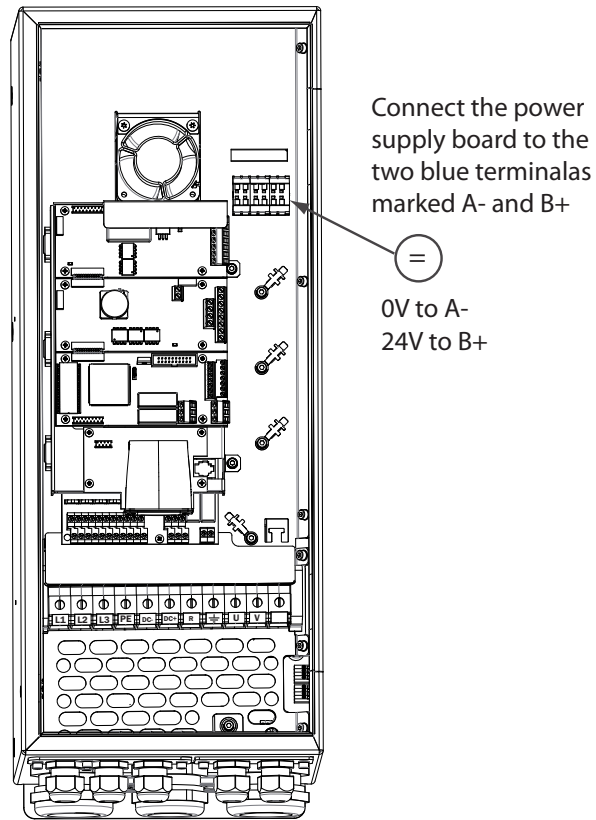

Fig. 121 Connection of standby supply option for SX-D4030 and SX-D4037

Table 38

Terminal	Name	Function	Specification
A-	0V	External, VSD main power independent, supply voltage for control and communication circuits	24 V <sub>DC</sub> ±10% Double isolated
B+	+24V		



## 13-10 Safe Stop option

To realize a Safe Stop configuration in accordance with Safe Torque Off (STO) EN-IEC 6206:20051 SIL 2 & EN-ISO 13849-1, the following three parts need to be attended to:

1. Inhibit trigger signals with safety relay K1 (via Safe Stop option board).
2. Enable input and control of VSD (via normal I/O control signals of VSD).
3. Power conductor stage (checking status and feedback of driver circuits and IGBT's).

To enable the VSD to operate and run the motor, the following signals should be active:

- "Inhibit" input, terminals 1 (DC+) and 2 (DC-) on the Safe Stop option board should be made active by connecting  $24 V_{DC}$  to secure the supply voltage for the driver circuits of the power conductors via safety relay K1. See also Fig. 124.
- High signal on the digital input, e.g. terminal 10 in Fig. 124, which is set to "Enable". For setting the digital input please refer to section 11-5-2, page 198.

These two signals need to be combined and used to enable the output of the VSD and make it possible to activate a Safe Stop condition.

**Note** The "Safe Stop" condition according to EN-IEC 62061:2005 SIL 2 & EN-ISO 13849-1:2006, can only be realized by de-activating both the "Inhibit" and "Enable" inputs.

When the "Safe Stop" condition is achieved by using these two different methods, which are independently controlled, this safety circuit ensures that the motor will not start running because:

- The  $24V_{DC}$  signal is taken away from the "Inhibit" input, terminals 1 and 2, the safety relay K1 is switched off.

The supply voltage to the driver circuits of the power conductors is switched off. This will inhibit the trigger pulses to the power conductors.

- The trigger pulses from the control board are shut down.

The Enable signal is monitored by the controller circuit which will forward the information to the PWM part on the Control board.

To make sure that the safety relay K1 has been switched off, this should be guarded externally to ensure that this relay did not refuse to act. The Safe Stop option board offers a feedback signal for this via a second forced switched safety relay K2 which is switched on when a detection circuit has confirmed that the supply voltage to the driver circuits is shut down. See Table 39 for the contacts connections.

To monitor the "Enable" function, the selection "RUN" on a digital output can be used. For setting a digital output, e.g. terminal 20 in the example Fig. 124, please refer to section 11-5-4, page 207 [540].

When the "Inhibit" input is de-activated, the VSD display will show a blinking "SST" indication in section D (bottom left corner) and the red Trip LED on the Control panel will blink.

To resume normal operation, the following steps have to be taken:

- Release "Inhibit" input;  $24V_{DC}$  (High) to terminal 1 and 2.
- Give a STOP signal to the VSD, according to the set Run/Stop Control in menu [215].
- Give a new Run command, according to the set Run/Stop Control in menu [215].

**Note** The method of generating a STOP command is dependent on the selections made in Start Signal Level/Edge [21A] and the use of a separate Stop input via digital input.

**Warning** The safe stop function can never be used for electrical maintenance. For electrical maintenance the VSD should always be disconnected from the supply voltage.

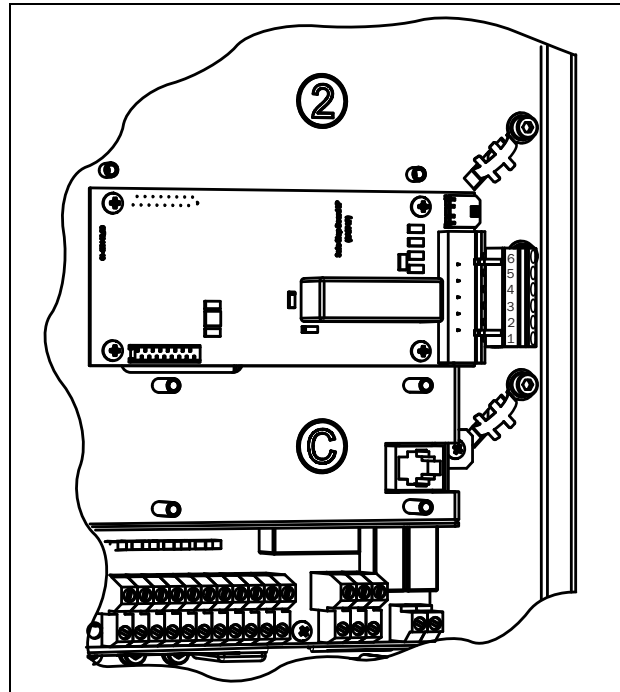

Fig. 122 Connection of safe stop option from SX-D40P7 up to SX-D4037

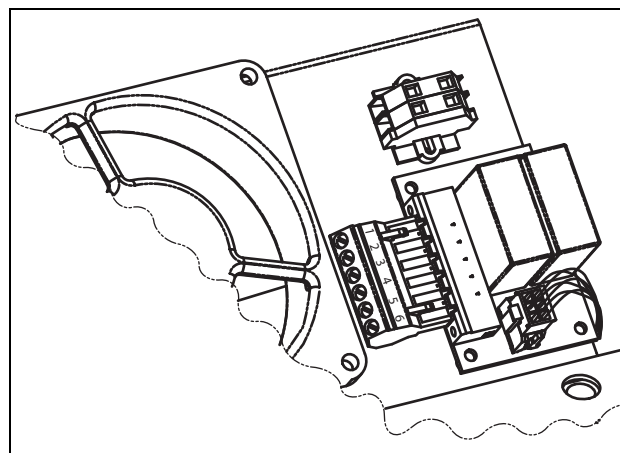

Fig. 123 Connection of safe stop option for SX-D4045 and up.

Table 39 Specification of Safe Stop option board

X1 pin	Name	Function	Specification
1	Inhibit +	Inhibit driver circuits of power conductors	DC 24 V (20–30 V)
2	Inhibit -		
3	NO contact relay K2	Feedback; confirmation of activated inhibit	48 V <sub>DC</sub> / 30 V <sub>AC</sub> /2 A
4	P contact relay K2		

Table 39 Specification of Safe Stop option board

5	GND	Supply ground	
6	+24 VDC	Supply Voltage for operating Inhibit input only.	+24 V <sub>DC</sub> , 50 mA

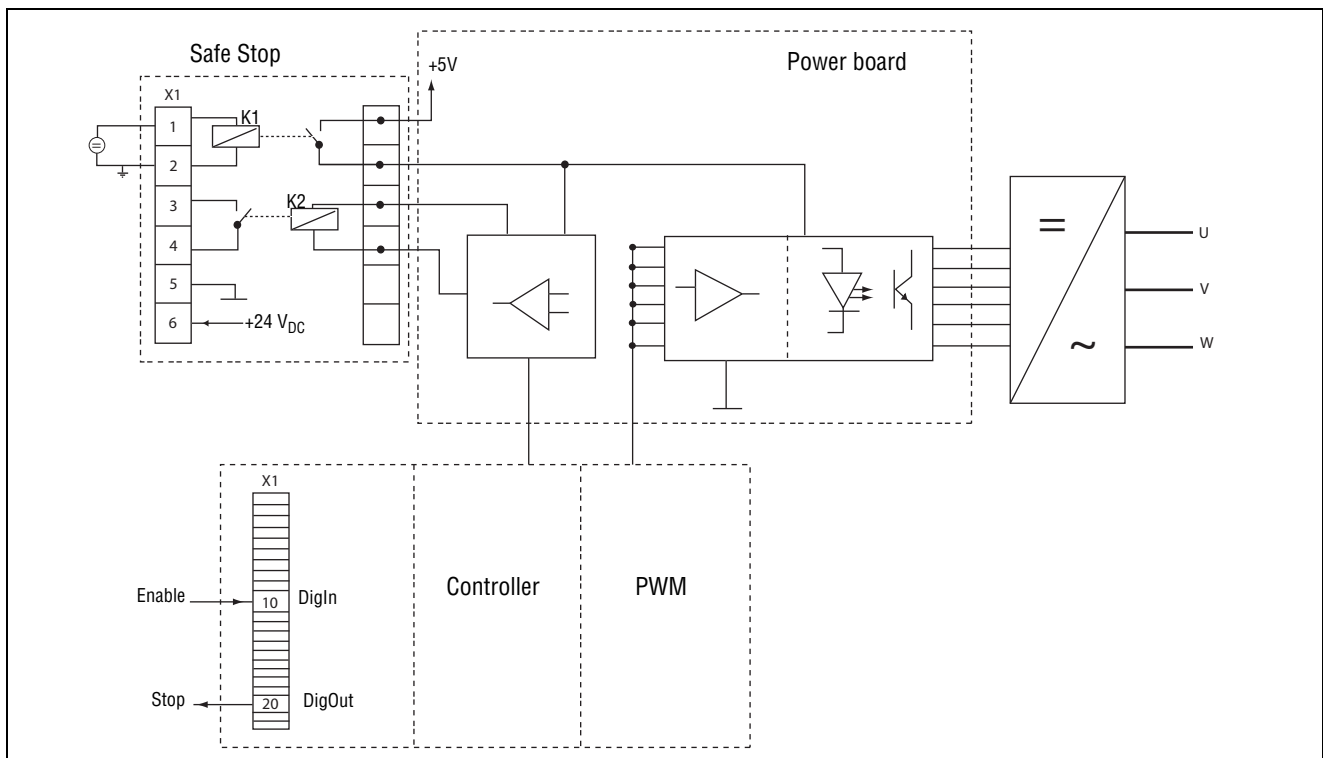

Fig. 124

## 13-11 Output coils

Output coils, which are supplied separately, are recommended for lengths of screened motor cable longer than 100 m. Because of the fast switching of the motor voltage and the capacitance of the motor cable both line to line and line to earth screen, large switching currents can be generated with long lengths of motor cable. Output coils prevent the VSD from tripping and should be installed as closely as possible to the VSD.

## 13-12 Liquid cooling

VSD modules in frame sizes E - K and F69 - K69 are available in a liquid cooled version. These units are designed for connection to liquid cooling system, normally a heat exchanger of liquid-liquid or liquid-air type. Heat exchanger is not part of the liquid cooling option.

Drive units with parallel power modules (frame size G - K69) are delivered with a dividing unit for connection of the cooling liquid. The drive units are equipped with rubber hoses with leak-proof quick couplings.

The liquid cooling option is described on a separate manual.



## SECTION 14 Technical Data

### 14-1 Electrical specifications related to model

Table 40 Typical motor power at mains voltage 400 V

Model	Max. output current [A]*	Normal duty (120%, 1 min every 10 min)		Heavy duty (150%, 1 min every 10 min)		Frame size
		Power @400V [kW]	Rated current [A]	Power @400V [kW]	Rated current [A]	
SX-D40P7-EF	3.8	0.75	2.5	0.55	2.0	B
SX-D41P5-EF	6.0	1.5	4.0	1.1	3.2	
SX-D42P2-EF	9.0	2.2	6.0	1.5	4.8	
SX-D43P0-EF	11.3	3	7.5	2.2	6.0	
SX-D44P0-EF	14.3	4	9.5	3	7.6	
SX-D45P5-EF	19.5	5.5	13.0	4	10.4	
SX-D47P5-EF	27.0	7.5	18.0	5.5	14.4	
SX-D4011-EF	39	11	26	7.5	21	C
SX-D4015-EF	46	15	31	11	25	
SX-D4018-EF	55	18.5	37	15	29.6	
SX-D4022-EF	69	22	46	18.5	37	
SX-D4030-EF	92	30	61	22	49	D
SX-D4037-EF	111	37	74	30	59	E
SX-D4045-EF	108	45	90	37	72	
SX-D4055-EF	131	55	109	45	87	
SX-D4075-EF	175	75	146	55	117	F
SX-D4090-EF	210	90	175	75	140	
SX-D4110-EF	252	110	210	90	168	G
SX-D4132-EF	300	132	250	110	200	
SX-□4160-EF	360	160	300	132	240	H
SX-□4200-EF	450	200	375	160	300	
SX-□4220-EF	516	220	430	200	344	I
SX-□4250-EF	600	250	500	220	400	
SX-□4315-EF	720	315	600	250	480	J
SX-□4355-EF	780	355	650	315	520	
SX-□4400-EF	900	400	750	355	600	K
SX-□4450-EF	1032	450	860	400	688	
SX-□4500-EF	1200	500	1000	450	800	K
SX-□4630-EF	1440	630	1200	500	960	
SX-□4800-EF	1800	800	1500	630	1200	K

\* Available during limited time and as long as allowed by drive temperature.

Table 41 Typical motor power at mains voltage 690 V

Model	Max. output current [A]*	Normal duty (120%, 1 min every 10 min)		Heavy duty (150%, 1 min every 10 min)		Frame size
		Power @690V [kW]	Rated current [A]	Power @690V [kW]	Rated current [A]	
SX-D6090-EF	108	90	90	75	72	F69
SX-D6110-EF	131	110	109	90	87	
SX-D6132-EF	175	132	146	110	117	
SX-D6160EF	210	160	175	132	140	
SX-□6200-EF	252	200	210	160	168	H69
SX-□6250-EF	300	250	250	200	200	
SX-□6315-EF	360	315	300	250	240	
SX-□6355-EF	450	355	375	315	300	
SX-□6450-EF	516	450	430	315	344	I69
SX-□6500-EF	600	500	500	355	400	
SX-□6600-EF	720	600	600	450	480	J69
SX-□6630EF	780	630	650	500	520	
SX-□6710-EF	900	710	750	600	600	K69
SX-□6800-EF	1032	800	860	650	688	
SX-□6900-EF	1080	900	900	710	720	
SX-□61K0-EF	1200	1000	1000	800	800	

\* Available during limited time and as long as allowed by drive temperature.

## 14-2 General electrical specifications

Table 42 General electrical specifications

### General

Mains voltage:	SX-4xxx-EF SX-6xxx-EF	230-480V +10%/-10% 500-690V +10%/-15%
Mains frequency:		45 to 65 Hz
Input power factor:		0.95
Output voltage:		0–Mains supply voltage:
Output frequency:		0–400 Hz
Output switching frequency:		3 kHz
Efficiency at nominal load:		97% up to SX-D47P5 98% rest of models

### Control signal inputs:

Analogue (differential)

Analogue Voltage/current:	0-±10 V/0-20 mA via switch
Max. input voltage:	+30 V/30 mA
Input impedance:	20 kΩ (voltage) 250 Ω (current)
Resolution:	11 bits + sign
Hardware accuracy:	1% type + 1 ½ LSB fsd
Non-linearity	1½ LSB

Digital:

Table 42 General electrical specifications

Input voltage:	High: >9 VDC, Low: <4 VDC
Max. input voltage:	+30 VDC
Input impedance:	<3.3 VDC: 4.7 k $\Omega$
Signal delay:	$\geq$ 3.3 VDC: 3.6 k $\Omega$ $\leq$ 8 ms

**Control signal outputs**

Analogue

Output voltage/current:	0-10 V/0-20 mA via software setting
Max. output voltage:	+15 V @5 mA cont.
Short-circuit current ( $\infty$ ):	+15 mA (voltage), +140 mA (current)
Output impedance:	10 $\Omega$ (voltage)
Resolution:	10 bit
Maximum load impedance for current	500 $\Omega$
Hardware accuracy:	1.9% type fsd (voltage), 2.4% type fsd (current)
Offset:	3 LSB
Non-linearity:	2 LSB

Digital

Output voltage:	High: >20 VDC @50 mA, >23 VDC open Low: <1 VDC @50 mA
Shortcircuit current( $\infty$ ):	100 mA max (together with +24 VDC)

Relays

Contacts	0.1 – 2 A/U <sub>max</sub> 250 VAC or 42 VDC
----------	--

**References**

+10VDC	+10 V <sub>DC</sub> @10 mA Short-circuit current +30 mA max
-10VDC	-10 V <sub>DC</sub> @10 mA
+24VDC	+24 V <sub>DC</sub> Short-circuit current +100 mA max (together with Digital Outputs)

### 14-3 Operation at higher temperatures

OMRON variable speed drives are made for operation at maximum of 40°C ambient temperature. However, for most models, it is possible to use the VSD at higher temperatures with little loss in performance. Table 43 shows ambient temperatures as well as derating for higher temperatures.

Table 43 Ambient temperature and derating 400–690 V types

Model SX-F	IP20		IP54	
	Max temp.	Derating: possible	Max temp.	Derating: possible
SX-D40P7-EF to SX-D4037-EF	–	–	40°C	Yes, -2.5%/°C to max +10°C
SX-D4045-EF to SX-D4132-EF SX-D6090-EF to SX-D6160-EF	–	–	40°C	Yes, -2.5%/°C to max +5°C
SX-□4160-EF to SX-□4800-EF SX-□6200-EF to SX-□61K0-EF	40°C	-2.5%/°C to max +5°C	40°C	-2.5%/°C to max +5°C

#### Example

In this example we have a motor with the following data that we want to run at the ambient temperature of 45°C:

Voltage 400 V  
 Current 165 A  
 Power 90 kW

#### Select variable speed drive

The ambient temperature is 5 °C higher than the maximum ambient temperature. The following calculation is made to select the correct VSD model.

Derating is possible with loss in performance of 2.5%/°C.

Derating will be:  $5 \times 2.5\% = 12.5\%$

Calculation for model SX-D4037-EF

$74 \text{ A} - (12.5\% \times 74) = 64.8 \text{ A}$ ; this is not enough.

Calculation for model SX-D4110-EF

$90 \text{ A} - (12.5\% \times 90) = 78.8 \text{ A}$

In this example we select the SX-D4045-EF.



## 14-4 Dimensions and Weights

The table below gives an overview of the dimensions and weights. The models SX-D4090-EF to SX-D4132-EFin 400 V and SX-D6090-EF to SX-D6250-EF in 690 V are available in IP54 as wall mounted modules. The models SX-\*4160-EF to SX-\*4800-EF in 400 V and SX-\*6315-EF to SX-\*61K0-EF in 690 V consist of 2, 3, 4 or 6 paralleled power electronic building block (PEBB) available in IP20 as wall mounted modules and in IP54 mounted standard cabinet

Protection class IP54 is according to the EN 60529 standard.

Table 44 Mechanical specifications, SX-F 400 V

Models	Frame size	Dim. H x W x D [mm] IP20 (-A4xxx)	Dim. H x W x D [mm] IP54 (-D4xxx)	Weight IP20 [kg]	Weight IP54 [kg]
40P7 to 47P5	B	–	416 x 203 x 200	–	12.5
4011 to 4022	C	–	512 x 178 x 292	–	24
4030 to 4037	D	–	590 x 220 x 295	–	32
4045 to 4055	E	–	950 x 285 x 314	–	56
4075 to 4090	E	–	950 x 285 x 314	–	60
4110 to 4132	F	–	950 x 345 x 314	–	74
4160 to 4200	G	1036 x 500 x 390	2250 x 600 x 500	140	350
4220 to 4250	H	1036 x 500 x 450	2250 x 600 x 600	170	380
4315 to 4400	I	1036 x 730 x 450	2250 x 900 x 600	248	506
4450 to 4500	J	1036 x 1100 x 450	2250 x 1200 x 600	340	697
4630 to 4800	K	1036 x 1560 x 450	2250 x 1800 x 600	496	987

Table 45 Mechanical specifications, SX-F 690 V

Models	Frame size	Dim. H x W x D [mm] IP20 (-A6xxx)	Dim. H x W x D [mm] IP54 (-A6xxx)	Weight IP20 [kg]	Weight IP54 [kg]
6090 to 6160	F69	–	1090 x 345 x 314	–	77
6200 to 6355	H69	1176 x 500 x 450	2250 x 600 x 600	176	399
6450 to 6500	I69	1176 x 730 x 450	2250 x 900 x 600	257	563
6600 to 6630	J69	1176 x 1100 x 450	2250 x 1200 x 600	352	773
6710 to 61K0	K69	1176 x 1560 x 450	2250 x 1800 x 600	514	1100

## 14-5 Environmental conditions

Table 46 Operation

Parameter	Normal operation
Nominal ambient temperature	0°C–40°C See table, see Table 43 for different conditions
Atmospheric pressure	86–106 kPa
Relative humidity, non-condensing	0–90%
Contamination, according to IEC 60721-3-3	No electrically conductive dust allowed. Cooling air must be clean and free from corrosive materials. Chemical gases, class 3C2. Solid particles, class 3S2.
Vibrations	According to IEC 600068-2-6, Sinusoidal vibrations: <ul style="list-style-type: none"> <li>• 10&lt;f&lt;57 Hz, 0.075 mm</li> <li>• 57&lt;f&lt;150 Hz, 1g</li> </ul>
Altitude	0–1000 m 480V VSD, with derating 1%/100 m of rated current up to 4000 m. 690V VSD, with derating 1%/100 m of rated current up to 2000 m.

Table 47 Storage

Parameter	Storage condition
Temperature	-20 to +60 °C
Atmospheric pressure	86–106 kPa
Relative humidity, non-condensing	0– 90%

## 14-6 Fuses, cable cross-sections and glands

### 14-6-1 According IEC ratings

Use mains fuses of the type gL/gG conforming to IEC 269 or installation cut-outs with similar characteristics. Check the equipment first before installing the glands.

Max. Fuse = maximum fuse value that still protects the VSD and upholds warranty.

**Note** The dimensions of fuse and cable cross-section are dependent on the application and must be determined in accordance with local regulations.

**Note** The dimensions of the power terminals used in the models 4160 to 4800 at 400 V and 6315 to 61K0 at 690 V can differ depending on customer specification.

Table 48 Fuses, cable cross-sections and glands for 400 V

Model	Nominal input current [A]	Maximum value fuse [A]	Cable cross section connector range [mm <sup>2</sup> ] for			Cable glands (clamping range [mm])	
			mains/motor	Brake	PE	mains/motor	Brake
SX-D40P7-EF	2.2	4	0.5 - 10	0.5 - 10	1.5 - 16	M32 opening	M25 opening
SX-D41P5-EF	3.5	4				M20+reducer (6 - 12)	M20+reducer (6-12)
SX-D42P2-EF	5.2	6				M32 (12-20) opening	M25 (10-14)
SX-D43P0-EF	6.9	10					
SX-D44P0-EF	8.7	10					
SX-D45P5-EF	11.3	16				M32 (16-25)/ M32 (13-18)	M25 (10-14)
SX-D47P5-EF	15.6	20					
SX-D4011-EF	22	25					
SX-D4015-EF	26	35	2.5 - 16 Stranded wire 2.5 - 25 Solid wire	6 - 35	M32 (15-21)	M25	
SX-D4018-EF	31	35			M40 (19-28)	M32	
SX-D4022-EF	38	50					
SX-D4030-EF	52	63	10 - 35 Stranded wire 10 - 50 Solid wire			M50 (27-35)	M40 (19-28)
SX-D4037-EF	65	80	16-95	16-95	16-95 (16-70) <sup>1</sup>	Ø17-42 cable entry or M50 (27-35)	Ø11-32 cable entry or M40 (19-28)
SX-D4045-EF	78	100					
SX-D4055-EF	94	100	35 - 150	16 - 95	35-150 (16-70) <sup>1</sup>	Ø23-55 cable entry or M63	Ø17-42 cable entry or M50
SX-D4075-EF	126	160					
SX-D4090-EF	152	160	35 - 250	35 - 150	35 - 250 (95-185) <sup>1</sup>	Ø23-55 cable entry or M63	Ø17-42 cable entry or M50
SX-D4110-EF	182	200					
SX-D4132-EF	216	250	(2x)35-240	frame	---	---	--
SX-□4160-EF	260	300					
SX-□4200-EF	324	355					
SX-□4220-EF	372	400					
SX-□4250-EF	432	500	(2x)35-240	frame	--	--	--

Table 48 Fuses, cable cross-sections and glands for 400 V

Model	Nominal input current [A]	Maximum value fuse [A]	Cable cross section connector range [mm <sup>2</sup> ] for			Cable glands (clamping range [mm])	
			mains/motor	Brake	PE	mains/motor	Brake
SX-□4315-EF	520	630	(3x)35-240		frame	--	--
SX-□4355-EF	562	630					
SX-□4400-EF	648	710	(3x)35-240		frame	--	--
SX-□4450-EF	744	800	(4x)35-240		frame	--	--
SX-□4500-EF	864	1000					
SX-□4630-EF	1037	1250	(6x)35-240		frame	--	--
SX-□4800-EF	1296	1500					

1. Values are valid when brake chopper electronics are built in.

**Note** For models 40P7 to 4037 the cable glands are optional

Table 49 Fuses, cable cross-sections and glands for 690 V

Model	Nominal input current [A]	Maximum value fuse [A]	Cable cross section connector range [mm <sup>2</sup> ] for			Cable glands (clamping range [mm])	
			mains/motor	Brake	PE	mains/motor	Brake
SX-D6090-EF	78	100	16 - 95	16 - 95	16-95 (16-70) <sup>1</sup>	Ø23-55 cable entry or M63	Ø17-42 cable entry or M50
SX-D6110-EF	94	100					
SX-D6132-EF	126	160	35 - 150	16 - 95	35-150 (16-70) <sup>1</sup>		
SX-D6160-EF	152	160					
SX-□6200-EF	182	200					
SX-□6250-EF	216	250					
SX-□6315-EF	260	300	(2x)35-150		frame	---	--
SX-□6355-EF	324	355	(3x)35-150		frame	--	--
SX-□6450-EF	372	400					
SX-□6500-EF	432	500	(4x)35-150		frame	--	--
SX-□6600-EF	520	630					
SX-□6630-EF	562	630	(6x)35-150		frame	--	--
SX-□6710-EF	648	710	(6x)35-150		frame	--	--
SX-□6800-EF	744	800					
SX-□6900-EF	795	900					
SX-□61K0-EF	864	1000					

1. Values are valid when brake chopper electronics are built in.

## 14-6-2 Fuses and cable dimensions according NEMA ratings

Table 50 Types and fuses

Model	Input current [Arms]	Mains input fuses	
		UL Class J TD (A)	Ferraz-Shawmut type
SX-D40P7-EF	2.2	6	AJT6
SX-D41P5-EF	3.5	6	AJT6
SX-D42P2-EF	5.2	6	AJT6
SX-D43P0-EF	6.9	10	AJT10
SX-D44P0-EF	8.7	10	AJT10
SX-D45P5-EF	11.3	15	AJT15
SX-D47P5-EF	15.6	20	AJT20
SX-D4011-EF	22	25	AJT25
SX-D4015-EF	26	30	AJT30
SX-D4018-EF	31	35	AJT35
SX-D4022-EF	38	45	AJT45
SX-D4030-EF	52	60	AJT60
SX-D4037-EF	65	80	AJT80
SX-D4045-EF	78	100	AJT100
SX-D4055-EF	94	110	AJT110
SX-D4075-EF	126	150	AJT150
SX-D4090-EF	152	175	AJT175
SX-D4110-EF	182	200	AJT200
SX-D4132-EF	216	250	AJT250
SX-□4160-EF	260	300	AJT300
SX-□4200-EF	324	350	AJT350
SX-□4220-EF	372	400	AJT400
SX-□4250-EF	432	500	AJT500
SX-□4315-EF	520	600	AJT600
SX-□4355-EF	562	600	AJT600
SX-□4400-EF	648	700	A4BQ700
SX-□4450-EF	744	800	A4BQ800
SX-□4500-EF	864	1000	A4BQ1000
SX-□4630-EF	1037	1200	A4BQ1200
SX-□4800-EF	1296	1500	A4BQ1500

Table 51 Type cables cross-sections and glands

Model	Cable cross section connector						Cable type
	Mains and motor		Brake		PE		
	Range	Tightening torque Nm/Lb-In	Range	Tightening torque Nm/Lb-In	Range	Tightening torque Nm/Lb-In	
SX-D40P7-EF	AWG 20 - AWG 6	1.3 / 11.5	AWG 20 - AWG 6	1.3 / 11.5	AWG 20 - AWG 6	2.6 / 23	Copper (Cu) 75°C
SX-D41P5-EF			AWG 16 - AWG 6		AWG 16 - AWG 6		
SX-D42P2-EF			AWG 14 - AWG 6		AWG 14 - AWG 6		
SX-D43P0-EF			AWG 12 - AWG 6		AWG 12 - AWG 6		
SX-D44P0-EF			AWG 10 - AWG 6		AWG 10 - AWG 6		
SX-D45P5-EF							
SX-D47P5-EF							
SX-D4011-EF	AWG 8 - AWG 6	1.3 / 11.5	AWG 8 - AWG 6	1.3 / 11.5	AWG 8 - AWG 6	2.6 / 23	
SX-D4015-EF			AWG 6		AWG 6		
SX-D4018-EF							
SX-D4022-EF	AWG 6		AWG 6		AWG 6		
SX-D4030-EF	AWG 4	1.6 / 14	AWG 4	1.6 / 14	AWG 4	1.6 / 14	
SX-D4037-EF	AWG 3	2.8 / 25	AWG 3	2.8 / 25	AWG 3	2.8 / 25	
SX-D4045-EF	AWG 2 - 300 kcmill	14 / 124 - 24 / 212 <sup>2</sup>	AWG 2 - AWG 3/0	14 / 124	AWG 2 - 300 kcmill	14 / 124 (10 / 88) <sup>1</sup>	
SX-D4055-EF	AWG 1/0 - 300 kcmill				AWG 1/0 - 300 kcmill		
SX-D4075-EF	AWG 3/0 - 300 kcmill				AWG 3/0 - 300 kcmill		
SX-D4090-EF	AWG 4/0 - 300 kcmill				AWG 4/0 - 300 kcmill		
SX-D4110-EF	300 kcmill	24 / 212	300 kcmill	24 / 212	300 kcmill	24 / 212 (10 / 88) <sup>1</sup>	
SX-D4132-EF							
SX-□4160-EF	2 x AWG 3/0 - 2 x 300 kcmill	24 / 212	2 x AWG 3/0 - 2 x 300 kcmill	24 / 212	frame	-	
SX-□4200-EF	2 x 250 kcmill - 2 x 300 kcmill		2 x 250 kcmill - 2 x 300 kcmill				
SX-□4220-EF	2 x 300 kcmill	24 / 212	2 x 300 kcmill	24 / 212	frame	-	
SX-□4250-EF	2 x 400 kcmill		2 x 400 kcmill				
SX-□4315-EF	3 x 300 kcmill	24 / 212	3 x 300 kcmill	24 / 212	frame	-	
SX-□4355-EF			3 x 400 kcmill				
SX-□4400-EF							
SX-□4450-EF	4 x 300 kcmill	24 / 212	4 x 300 kcmill	24 / 212	frame	-	
SX-□4500-EF	4 x 400 kcmill		4 x 400 kcmill				
SX-□4630-EF	6 x 300 kcmill	24 / 212	6 x 300 kcmill	24 / 212	frame	-	
SX-□4800-EF	6 x 400 kcmill		6 x 400 kcmill				

1. Values are valid when brake chopper electronics are built in.

2. AWG 2 - AWG 3/0 = 14 Nm / 124 Lb-In

AWG 4/0 - 300 kcmill = 24 Nm / 212 Lb-In

## 14-7 Control signals

Table 52

Terminal X1	Name:	Function (Default):	Signal:	Type:
1	+10 V	+10 VDC Supply voltage	+10 VDC, max 10 mA	output
2	AnIn1	Process reference	0 -10 VDC or 0/4–20 mA bipolar: -10 - +10 VDC or -20 - +20 mA	analogue input
3	AnIn2	Off	0 -10 VDC or 0/4–20 mA bipolar: -10 - +10 VDC or -20 - +20 mA	analogue input
4	AnIn3	Off	0 -10 VDC or 0/4–20 mA bipolar: -10 - +10 VDC or -20 - +20 mA	analogue input
5	AnIn4	Off	0 -10 VDC or 0/4–20 mA bipolar: -10 - +10 VDC or -20 - +20 mA	analogue input
6	-10 V	-10VDC Supply voltage	-10 VDC, max 10 mA	output
7	Common	Signal ground	0V	output
8	DigIn 1	RunL	0-8/24 VDC	digital input
9	DigIn 2	RunR	0-8/24 VDC	digital input
10	DigIn 3	Off	0-8/24 VDC	digital input
11	+24 V	+24VDC Supply voltage	+24 VDC, 100 mA	output
12	Common	Signal ground	0 V	output
13	AnOut 1	Min speed to max speed	0 ±10 VDC or 0/4– +20 mA	analogue output
14	AnOut 2	0 to max torque	0 ±10 VDC or 0/4– +20 mA	analogue output
15	Common	Signal ground	0 V	output
16	DigIn 4	Off	0-8/24 VDC	digital input
17	DigIn 5	Off	0-8/24 VDC	digital input
18	DigIn 6	Off	0-8/24 VDC	digital input
19	DigIn 7	Off	0-8/24 VDC	digital input
20	DigOut 1	Ready	24 VDC, 100 mA	digital output
21	DigOut 2	Brake	24 VDC, 100 mA	digital output
22	DigIn 8	RESET	0-8/24 VDC	digital input
<b>Terminal X2</b>				
31	N/C 1	Relay 1 output Trip, active when the VSD is in a TRIP condition N/C is opened when the relay is active (valid for all relays) N/O is closed when the relay is active (valid for all relays)	potential free change over 0.1 – 2 A/U <sub>max</sub> 250 VAC or 42 VDC	relay output
32	COM 1			
33	N/O 1			
41	N/C 2	Relay 2 Output Run, active when the VSD is started	potential free change over 0.1 – 2 A/U <sub>max</sub> 250 VAC or 42 VDC	relay output
42	COM 2			
43	N/O 2			
<b>Terminal X3</b>				
51	COM 3	Relay 3 Output	potential free change over 0.1 – 2 A/U <sub>max</sub> 250 VAC or 42 VDC	relay output
52	N/O 3	Off		

## SECTION 15

### Menu List

			DEFAULT	CUSTOM
100	Preferred View			
	110	1st Line	Process Val	
	120	2nd Line	Torque	
200	Main Setup			
	210	Operation		
	211	Language	English	
	212	Select Motor	M1	
	213	Drive Mode	Speed	
	214	Ref Control	Remote	
	215	Run/Stp Ctrl	Remote	
	216	Reset Ctrl	Remote	
	217	Local/Rem	Off	
	2171	LocRefCtrl	Standard	
	2172	LocRunCtrl	Standard	
	218	Lock Code?	0	
	219	Rotation	R+L	
	21A	Level/Edge	Level	
	21B	Supply Volts	Not Defined	
	220	Motor Data		
	221	Motor Volts	$U_{NOM}$ V	
	222	Motor Freq	50Hz	
	223	Motor Power	$(P_{NOM})$ W	
	224	Motor Curr	$(I_{NOM})$ A	
	225	Motor Speed	$(n_{MOT})$ rpm	
	226	Motor Poles	-	
	227	Motor Cos $\phi$	Depends on $P_{nom}$	
	228	Motor Vent	Self	
	229	Motor ID-Run	Off	
	22B	Encoder	Off	
	22C	Enc Pulses	1024	
	22D	Enc Speed	0rpm	
	22F	Enc Puls Ctr	0	
	230	Mot Protect		
	231	Mot $I^2t$ Type	Trip	
	232	Mot $I^2t$ Curr	100%	
	233	Mot $I^2t$ Time	60s	
	234	Thermal Prot	Off	
	235	Motor Class	F 140°C	
	236	PT100 Inputs		
	237	Motor PTC	Off	
	240	Set Handling		
	241	Select Set	A	

**Section 15 Menu List**

		DEFAULT	CUSTOM
242	Copy Set	A>B	
243	Default>Set	A	
244	Copy to CP	No Copy	
245	Load from CP	No Copy	
250	Autoreset		
251	No of Trips	0	
252	Overtemp	Off	
253	Overvolt D	Off	
254	Overvolt G	Off	
255	Overvolt	Off	
256	Motor Lost	Off	
257	Locked Rotor	Off	
258	Power Fault	Off	
259	Undervoltage	Off	
25A	Motor I <sup>2</sup> t	Off	
25B	Motor I <sup>2</sup> t TT	Trip	
25C	PT100	Off	
25D	PT100 TT	Trip	
25E	PTC	Off	
25F	PTC TT	Trip	
25G	Ext Trip	Off	
25H	Ext Trip TT	Trip	
25I	Com Error	Off	
25J	Com Error TT	Trip	
25K	Min Alarm	Off	
25L	Min Alarm TT	Trip	
25M	Max Alarm	Off	
25N	Max Alarm TT	Trip	
25O	Over curr F	Off	
25Q	Over speed	Off	
25R	Ext Mot Temp	Off	
25S	Ext Mot TT	Trip	
25T	LC Level	Off	
25U	LC Level TT	Trip	
25V	Brk Fault	Off	
260	Serial Com		
261	Com Type	RS232/485	
262	RS232/485		
2621	Baudrate	9600	
2622	Address	1	
263	Fieldbus		
2631	Address	62	
2632	PrData Mode	Basic	
2633	Read/Write	RW	
2634	AddPrValue	0	
264	Comm Fault		



**Section 15 Menu List**

		DEFAULT	CUSTOM	
	2641	ComFlt Mode	Off	
	2642	ComFlt Time	0.5 s	
265	Ethernet			
	2651	IP Address	0.0.0.0	
	2652	MAC Address	000000000000	
	2653	Subnet Mask	0.0.0.0	
	2654	Gateway	0.0.0.0	
	2655	DHCP	Off	
266	FB Signal			
	2661	FB Signal 1		
	2662	FB Signal 2		
	2663	FB Signal 3		
	2664	FB Signal 4		
	2665	FB Signal 5		
	2666	FB Signal 6		
	2667	FB Signal 7		
	2668	FB Signal 8		
	2669	FB Signal 9		
	266A	FB Signal 10		
	266B	FB Signal 11		
	266C	FB Signal 12		
	266D	FB Signal 13		
	266E	FB Signal 14		
	266F	FB Signal 15		
	266G	FB Signal 16		
	269	FB Status		
300	Process			
	310	Set/View ref		
	320	Proc Setting		
	321	Proc Source	Speed	
	322	Proc Unit	Off	
	323	User Unit	0	
	324	Process Min	0	
	325	Process Max	0	
	326	Ratio	Linear	
	327	F(Val) PrMin	Min	
	328	F(Val) PrMax	Max	
330	Start/Stop			
	331	Acc Time	10.00s	
	332	Dec Time	10.00s	
	333	Acc MotPot	16.00s	
	334	Dec MotPot	16.00s	
	335	Acc>Min Spd	10.00s	
	336	Dec<Min Spd	10.00s	
	337	Acc Rmp	Linear	
	338	Dec Rmp	Linear	

## Section 15 Menu List

		DEFAULT	CUSTOM
339	Start Mode	Normal DC	
33A	Spinstart	Off	
33B	Stop Mode	Decel	
33C	Brk Release	0.00s	
33D	Release Spd	0rpm	
33E	Brk Engage	0.00s	
33F	Brk Wait	0.00s	
33G	Vector Brake	Off	
33H	Brk Fault	1.00s	
33I	Release Torque	0%	
340	Speed		
341	Min Speed	0rpm	
342	Stp<MinSpd	Off	
343	Max Speed	1500rpm	
344	SkipSpd 1 Lo	0rpm	
345	SkipSpd 1 Hi	0rpm	
346	SkipSpd 2 Lo	0rpm	
347	SkipSpd 2 Hi	0rpm	
348	Jog Speed	50rpm	
350	Torques		
351	Max Torque	120%	
352	IxR Comp	Automatic	
353	IxR CompUsr	0%	
354	Flux optim	Off	
355	Max Power	Off	
360	Preset Ref		
361	Motor Pot	Non Volatile	
362	Preset Ref 1	0 rpm	
363	Preset Ref 2	250 rpm	
364	Preset Ref 3	500 rpm	
365	Preset Ref 4	750 rpm	
366	Preset Ref 5	1000 rpm	
367	Preset Ref 6	1250 rpm	
368	Preset Ref 7	1500 rpm	
369	Keyb Ref	Normal	
370	Spd Ctrl PI		
371	Spd PI Auto	Off	
372	Spd P Gain		
373	Spd I Time		
380	ProcCtrlPID		
381	PID Control	Off	
382	PID Autotune	Off	
383	PID P Gain	1.0	
384	PID I Time	1.00s	
385	PID D Time	0.00s	
386	PID<MinSpd	Off	

**Section 15 Menu List**

		DEFAULT	CUSTOM	
	387	PID Act Marg	0	
	388	PID Stdy Tst	Off	
	389	PID Stdy Mar	0	
390	Pump/Fan Ctrl			
	391	Pump enable	Off	
	392	No of Drives	2	
	393	Select Drive	Sequence	
	394	Change Cond	Both	
	395	Change Timer	50h	
	396	Drives on Ch	0	
	397	Upper Band	10%	
	398	Lower Band	10%	
	399	Start Delay	0s	
	39A	Stop Delay	0s	
	39B	Upp Band Lim	0%	
	39C	Low Band Lim	0%	
	39D	Settle Start	0s	
	39E	TransS Start	60%	
	39F	Settle Stop	0s	
	39G	TransS Stop	60%	
	39H	Run Time 1	00:00:00	
	39H1	Rst Run Tm1	No	
	39I	Run Time 2	00:00:00	
	39I1	Rst Run Tm2	No	
	39J	Run Time 3	00:00:00	
	39J1	Rst Run Tm3	No	
	39K	Run Time 4	00:00:00	
	39K1	Rst Run Tm4	No	
	39L	Run Time05	00:00:00	
	39L1	Rst Run Tm5	No	
	39M	Run Time 6	00:00:00	
	39M1	Rst Run Tm6	No	
	39N	Pump 123456		
	39P	No of Backup	0	
3A0	Crane Option			
	3A1	Crane enable	Off	
	3A2	Control	4-Speed	
	3A3	Crane Relay 1	Brake	
	3A4	Crane Relay 2	Brake	
	3A5	PreLimSwSpd		
	3A6	CrawlSpd H/R		
	3A7	CrawlSpd L/L		
	3A8	Speed 2		
	3A9	Speed 3		
	3AA	Speed 4		
	3AB	Dev Bandwidt		

## Section 15 Menu List

		DEFAULT	CUSTOM
	3AC	Dev Time	ms
	3AD	LAFS Load	%
	3AE	Crane Inputs	
	3AF	CraneOutputs	
	3AG	Crane N Function	Zero Pos
400	Monitor/Prot		
	410	Load Monitor	
	411	Alarm Select	Off
	412	Alarm trip	Off
	413	Ramp Alarm	Off
	414	Start Delay	2s
	415	Load Type	Basic
	416	Max Alarm	
	4161	MaxAlarmMar	15%
	4162	MaxAlarmDel	0.1s
	417	Max Pre alarm	
	4171	MaxPreAlMar	10%
	4172	MaxPreAlDel	0.1s
	418	Min Pre Alarm	
	4181	MinPreAlMar	10%
	4182	MinPreAlDel	0.1s
	419	Min Alarm	
	4191	MinAlarmMar	15%
	4192	MinAlarmDel	0.1s
	41A	Autoset Alrm	No
	41B	Normal Load	100%
	41C	Load Curve	
	41C1	Load Curve 1	100%
	41C2	Load Curve 2	100%
	41C3	Load Curve 3	100%
	41C4	Load Curve 4	100%
	41C5	Load Curve 5	100%
	41C6	Load Curve 6	100%
	41C7	Load Curve 7	100%
	41C8	Load Curve 8	100%
	41C9	Load Curve 9	100%
	420	Process Prot	
	421	Low Volt OR	On
	422	Rotor Locked	Off
	423	Motor lost	Off
	424	Overvolt Ctrl	On
500	I/Os		
	510	An Inputs	
	511	AnIn1 Fc	Process Ref
	512	AnIn1 Setup	4-20mA
	513	AnIn1 Advn	

## Section 15 Menu List

		DEFAULT	CUSTOM
5131	AnIn1 Min	4mA	
5132	AnIn1 Max	20.00mA	
5133	AnIn1 Bipol	20.00mA	
5134	AnIn1 FcMin	Min	
5135	AnIn1 ValMin	0	
5136	AnIn1 FcMax	Max	
5137	AnIn1 ValMax	0	
5138	AnIn1 Oper	Add+	
5139	AnIn1 Filt	0.1s	
513A	AnIn1 Enabl	On	
514	AnIn2 Fc	Off	
515	AnIn2 Setup	4-20mA	
516	AnIn2 Advan		
5161	AnIn2 Min	4mA	
5162	AnIn2 Max	20.00mA	
5163	AnIn2 Bipol	20.00mA	
5164	AnIn2 FcMin	Min	
5165	AnIn2 ValMin	0	
5166	AnIn2 FcMax	Max	
5167	AnIn2 ValMax	0	
5168	AnIn2 Oper	Add+	
5169	AnIn2 Filt	0.1s	
516A	AnIn2 Enabl	On	
517	AnIn3 Fc	Off	
518	AnIn3 Setup	4-20mA	
519	AnIn3 Advan		
5191	AnIn3 Min	4mA	
5192	AnIn3 Max	20.00mA	
5193	AnIn3 Bipol	20.00mA	
5194	AnIn3 FcMin	Min	
5195	AnIn3 ValMin	0	
5196	AnIn3 FcMax	Max	
5197	AnIn3 ValMax	0	
5198	AnIn3 Oper	Add+	
5199	AnIn3 Filt	0.1s	
519A	AnIn3 Enabl	On	
51A	AnIn4 Fc	Off	
51B	AnIn4 Setup	4-20mA	
51C	AnIn4 Advan		
51C1	AnIn4 Min	4mA	
51C2	AnIn4 Max	20.00mA	
51C3	AnIn4 Bipol	20.00mA	
51C4	AnIn4 FcMin	Min	
51C5	AnIn4 ValMin	0	
51C6	AnIn4 FcMax	Max	
51C7	AnIn4 ValMax	0	

		DEFAULT	CUSTOM
	51C8	AnIn4 Oper	Add+
	51C9	AnIn4 Filt	0.1s
	51CA	AnIn4 Enabl	On
520	Dig Inputs		
	521	DigIn 1	RunL
	522	DigIn 2	RunR
	523	DigIn 3	Off
	524	DigIn 4	Off
	525	DigIn 5	Off
	526	DigIn 6	Off
	527	DigIn 7	Off
	528	DigIn 8	Reset
	529	B(oard)1 DigIn 1	Off
	52A	B(oard)1 DigIn 2	Off
	52B	B(oard)1 DigIn 3	Off
	52C	B(oard)2 DigIn 1	Off
	52D	B(oard)2 DigIn 2	Off
	52E	B(oard)2 DigIn 3	Off
	52F	B(oard)3 DigIn 1	Off
	52G	B(oard)3 DigIn 2	Off
	52H	B(oard)3 DigIn 3	Off
530	An Outputs		
	531	AnOut1 Fc	Speed
	532	AnOut1 Setup	4-20mA
	533	AnOut1 Adv	
	5331	AnOut 1 Min	4mA
	5332	AnOut 1 Max	20.0mA
	5333	AnOut1Bipol	20.0mA
	5334	AnOut1 FcMin	Min
	5335	AnOut1 VIMin	0
	5336	AnOut1 FcMax	Max
	5337	AnOut1 VIMax	0
	534	AnOut2 FC	Torque
	535	AnOut2 Setup	4-20mA
	536	AnOut2 Advan	
	5361	AnOut 2 Min	4mA
	5362	AnOut 2 Max	20.0mA
	5363	AnOut2Bipol	20.0mA
	5364	AnOut2 FcMin	Min
	5365	AnOut2 VIMin	0
	5366	AnOut2 FcMax	Max
	5367	AnOut2 VIMax	0
540	Dig Outputs		
	541	DigOut 1	Ready
	542	DigOut 2	Brake
550	Relays		

		DEFAULT	CUSTOM
551	Relay 1	Trip	
552	Relay 2	Run	
553	Relay 3	Off	
554	B(oard)1 Relay 1	Off	
555	B(oard)1 Relay 2	Off	
556	B(oard)1 Relay 3	Off	
557	B(oard)2 Relay 1	Off	
558	B(oard)2 Relay 2	Off	
559	B(oard)2 Relay 3	Off	
55A	B(oard)3 Relay 1	Off	
55B	B(oard)3 Relay 2	Off	
55C	B(oard)3 Relay 3	Off	
55D	Relay Adv		
55D1	Relay 1 Mode	N.O	
55D2	Relay 2 Mode	N.O	
55D3	Relay 3 Mode	N.O	
55D4	B1R1 Mode	N.O	
55D5	B1R2 Mode	N.O	
55D6	B1R3 Mode	N.O	
55D7	B2R1 Mode	N.O	
55D8	B2R2 Mode	N.O	
55D9	B2R3 Mode	N.O	
55DA	B3R1 Mode	N.O	
55DB	B3R2 Mode	N.O	
55DC	B3R3 Mode	N.O	
560	Virtual I/Os		
561	VIO 1 Dest	Off	
562	VIO 1 Source	Off	
563	VIO 2 Dest	Off	
564	VIO 2 Source	Off	
565	VIO 3 Dest	Off	
566	VIO 3 Source	Off	
567	VIO 4 Dest	Off	
568	VIO 4 Source	Off	
569	VIO 5 Dest	Off	
56A	VIO 5 Source	Off	
56B	VIO 6 Dest	Off	
56C	VIO 6 Source	Off	
56D	VIO 7 Dest	Off	
56E	VIO 7 Source	Off	
56F	VIO 8 Dest	Off	
56G	VIO 8 Source	Off	
600	Logical&Timers		
610	Comparators		
611	CA1 Setup		
6111	CA1 Value	Speed	

## Section 15 Menu List

		DEFAULT	CUSTOM
6112	CA1 Level HI	300rpm	
6113	CA1 Level LO	200rpm	
6114	CA1 Type	Hysteresis	
6115	CA1 Bipolar	Unipolar	
612	CA2 Setup		
6121	CA2 Value	Torque	
6122	CA2 Level HI	20%	
6123	CA2 Level LO	10%	
6124	CA2 Type	Hysteresis	
6125	CA2 Bipolar	Unipolar	
613	CA3 Setup		
6131	CA3 Value	Process Val	
6132	CA3 Level HI	300rpm	
6133	CA3 Level LO	200rpm	
6134	CA3 Type	Hysteresis	
6135	CA3 Bipolar	Unipolar	
614	CA4 Setup		
6141	CA4 Value	Process Err	
6142	CA4 Level HI	100 rpm	
6143	CA4 Level LO	-100 rpm	
6144	CA4 Type	Window	
6145	CA4 Bipolar	Bipolar	
615	CD Setup		
6151	CD1	Run	
6152	CD2	DigIn 1	
6153	CD3	Trip	
6154	CD4	Ready	
620	Logic Output Y		
621	Y Comp 1	CA1	
622	Y Operator 1	&	
623	Y Comp 2	!A2	
624	Y Operator 2	&	
625	Y Comp 3	CD1	
630	Logic Z		
631	Z Comp 1	CA1	
632	Z Operator 1	&	
633	Z Comp2	!A2	
634	Z Operator 2	&	
635	Z Comp 3	CD1	
640	Timer1		
641	Timer1 Trig	Off	
642	Timer1 Mode	Off	
643	Timer1 Delay	0:00:00	
644	Timer 1 T1	0:00:00	
645	Timer1 T2	0:00:00	
649	Timer1 Value	0:00:00	



## Section 15 Menu List

		DEFAULT	CUSTOM
650	Timer2		
	651	Timer2 Trig	Off
	652	Timer2 Mode	Off
	653	Timer2 Delay	0:00:00
	654	Timer 2 T1	0:00:00
	655	Timer2 T2	0:00:00
	659	Tmer2 Value	0:00:00
700	Oper/Status		
	710	Operation	
	711	Process Val	
	712	Speed	
	713	Torque	
	714	Shaft Power	
	715	Electrical Power	
	716	Current	
	717	Output volt	
	718	Frequency	
	719	DC Voltage	
	71A	Heatsink Tmp	
	71B	PT100_1_2_3	
	720	Status	
	721	VSD Status	
	722	Warning	
	723	DigIn Status	
	724	DigOut Status	
	725	AnIn Status 1-2	
	726	AnIn Status 3-4	
	727	AnOut Status 1-2	
	728	IO Status B1	
	729	IO Status B2	
	72A	IO Status B3	
	730	Stored Val	
	731	Run Time	00:00:00
	7311	Reset RunTm	No
	732	Mains Time	00:00:00
	733	Energy	kWh
	7331	Rst Energy	No
800	View TripLog		
	810	Trip Message	
	811	Process Value	
	812	Speed	
	813	Torque	
	814	Shaft Power	
	815	Electrical Power	
	816	Current	
	817	Output voltage	

		DEFAULT	CUSTOM
818	Frequency		
819	DC Link voltage		
81A	Heatsink Tmp		
81B	PT100_1, 2, 3		
81C	FI Status		
81D	DigIn status		
81E	DigOut status		
81F	AnIn status 1 2		
81G	AnIn status 3 4		
81H	AnOut status 1 2		
81I	IO Status B1		
81J	IO Status B2		
81K	IO Status B3		
81L	Run Time		
81M	Mains Time		
81N	Energy		
81O	Process reference		
820	Trip Message		
821	Process Value		
822	Speed		
823	Torque		
824	Shaft Power		
825	Electrical Power		
826	Current		
827	Output voltage		
828	Frequency		
829	DC Link voltage		
82A	Heatsink Tmp		
82B	PT100_1, 2, 3		
82C	FI Status		
82D	DigIn status		
82E	DigOut status		
82F	AnIn status 1 2		
82G	AnIn status 3 4		
82H	AnOut status 1 2		
82I	IO Status B1		
82J	IO Status B2		
82K	IO Status B3		
82L	Run Time		
82M	Mains Time		
82N	Energy		
82O	Process reference		
830	Trip Message		
831	Process Value		
832	Speed		
833	Torque		

## Section 15 Menu List

		DEFAULT	CUSTOM
834	Shaft Power		
835	Electrical Power		
836	Current		
837	Output voltage		
838	Frequency		
839	DC Link voltage		
83A	Heatsink Temperature		
83B	PT100_1, 2, 3		
83C	FI Status		
83D	DigIn status		
83E	DigOut status		
83F	AnIn status 1 2		
83G	AnIn status 3 4		
83H	AnOut status 1 2		
83I	IO Status B1		
83J	IO Status B2		
83K	IO Status B3		
83L	Run Time		
83M	Mains Time		
83N	Energy		
83O	Process reference		
840	Trip Message		
841	Process Value		
842	Speed		
843	Torque		
844	Shaft Power		
845	Electrical Power		
846	Current		
847	Output voltage		
848	Frequency		
849	DC Link voltage		
84A	Heatsink Tmp		
84B	PT100_1, 2, 3		
84C	FI Status		
84D	DigIn status		
84E	DigOut status		
84F	AnIn status 1 2		
84G	AnIn status 3 4		
84H	AnOut status 1 2		
84I	IO Status B1		
84J	IO Status B2		
84K	IO Status B3		
84L	Run Time		
84M	Mains Time		
84N	Energy		
84O	Process reference		

		DEFAULT	CUSTOM
850	Trip Message		
851	Process Value		
852	Speed		
853	Torque		
854	Shaft Power		
855	Electrical Power		
856	Current		
857	Output voltage		
858	Frequency		
859	DC Link voltage		
85A	Heatsink Tmp		
85B	PT100_1, 2, 3		
85C	FI Status		
85D	DigIn status		
85E	DigOut status		
85F	AnIn 1 2		
85G	AnIn 3 4		
85H	AnIOut 1 2		
85I	IO Status B1		
85J	IO Status B2		
85K	IO Status B3		
85L	Run Time		
85M	Mains Time		
85N	Energy		
85O	Process reference		
860	Trip Message		
861	Process Value		
862	Speed		
863	Torque		
864	Shaft Power		
865	Electrical Power		
866	Current		
867	Output voltage		
868	Frequency		
869	DC Link voltage		
86A	Heatsink Tmp		
86B	PT100_1, 2, 3		
86C	FI Status		
86D	DigIn status		
86E	DigOut status		
86F	AnIn 1 2		
86G	AnIn 3 4		
86H	AnOut 1 2		
86I	IO Status B1		
86J	IO Status B 2		
86K	IO Status B3		

## Section 15 Menu List

		DEFAULT	CUSTOM
	86L	Run Time	
	86M	Mains Time	
	86N	Energy	
	86O	Process reference	
870	Trip Message		
	871	Process Value	
	872	Speed	
	873	Torque	
	874	Shaft Power	
	875	Electrical Power	
	876	Current	
	877	Output voltage	
	878	Frequency	
	879	DC Link voltage	
	87A	Heatsink Tmpe	
	87B	PT100_1, 2, 3	
	87C	FI Status	
	87D	DigIn status	
	87E	DigOut status	
	87F	AnIn status 1 2	
	87G	AnIn status 3 4	
	87H	AnOut status 1 2	
	87I	IO Status B1	
	87J	IO Status B2	
	87K	IO Status B3	
	87L	Run Time	
	87M	Mains Time	
	87N	Energy	
	87O	Process reference	
880	Trip Message		
	881	Process Value	
	882	Speed	
	883	Torque	
	884	Shaft Power	
	885	Electrical Power	
	886	Current	
	887	Output voltage	
	888	Frequency	
	889	DC Link voltage	
	88A	Heatsink Tmp	
	88B	PT100_1, 2, 3	
	88C	FI Status	
	88D	DigIn status	
	88E	DigOut status	
	88F	AnIn status 1 2	
	88G	AnIn status 3 4	

## Section 15 Menu List

		DEFAULT	CUSTOM
	88H	AnOut status 1 2	
	88I	IO Status B1	
	88J	IO Status B2	
	88K	IO Status B3	
	88L	Run Time	
	88M	Mains Time	
	88N	Energy	
	88O	Process reference	
890	Trip Message		
	891	Process Value	
	892	Speed	
	893	Torque	
	894	Shaft Power	
	895	Electrical Power	
	896	Current	
	897	Output voltage	
	898	Frequency	
	899	DC Link voltage	
	89A	Heatsink Tmp	
	89B	PT100_1, 2, 3	
	89C	FI Status	
	89D	DigIn status	
	89E	DigOut status	
	89F	AnIn status 1 2	
	89G	AnIn status 3 4	
	89H	AnOut status 1 2	
	89I	IO Status B1	
	89J	IO Status B2	
	89K	IO Status B3	
	89L	Run Time	
	89M	Mains Time	
	89N	Energy	
	89O	Process reference	
8A0	Reset Trip	No	
900	System Data		
	920	VSD Data	
	921	VSD Type	
	922	Software	
	923	Unit name	0

## Symbols

- +10VDC Supply voltage ..... 286
- +24VDC Supply voltage ..... 286

## Numerics

- 10VDC Supply voltage ..... 286
- 4-20mA ..... 190

## A

- Abbreviations ..... 11
- Acceleration ..... 131, 135
  - Acceleration ramp ..... 135
  - Acceleration time ..... 131
  - Ramp type ..... 135
- Alarm trip ..... 177
- Alternating MASTER ..... 161
- Analogue comparators ..... 215
- Analogue input ..... 187
  - AnIn1 ..... 187
  - AnIn2 ..... 195, 196, 197
  - Offset ..... 189, 202
- Analogue Output ..... 201, 206, 286
  - AnOut 1 ..... 201, 206
  - Output configuration ..... 202, 206
- AND operator ..... 230
- AnIn2 ..... 196
- AnIn3 ..... 197
- AnIn4 ..... 198
- Autoreset ..... vi, 58, 106, 262
- Autotune ..... 153

## B

- Baudrate ..... 75, 118, 119, 120
- Brake chopper ..... 268
- Brake function ..... 138, 139
  - Bake release time ..... 138
  - Brake ..... 140
  - Brake Engage Time ..... 140
  - Brake wait time ..... 140
  - Release speed ..... 139
  - Vector Brake ..... 140
- Brake functions
  - Frequency ..... 187
- Brake resistors ..... 268

## C

- Cable cross-section ..... 282
- Cable specifications ..... 34
- CE-marking ..... 10
- Change Condition ..... 162
- Change Timer ..... 162, 163
- Clockwise rotary field ..... 199
- Comparators ..... 215
- Connecting control signals ..... 45
- Connections
  - Brake chopper connections ..... 26

- Control signal connections ..... 45
- Mains supply ..... 26, 38
- Motor earth ..... 26, 38
- Motor output ..... 26, 38
- Safety earth ..... 26, 38
- Control panel ..... 67
- Control Panel memory ..... 61
  - Copy all settings to Control Panel ..... 105
  - Frequency ..... 187
- Control signal connections ..... 45
- Control signals ..... 42, 47
  - Edge-controlled ..... 59, 90
  - Level-controlled ..... 58, 90
- Counter-clockwise rotary field ..... 199
- Current ..... 43
- Current control (0-20mA) ..... 48

## D

- DC-link residual voltage ..... iv
- Deceleration ..... 132
  - Deceleration time ..... 132
  - Ramp type ..... 136
- Declaration of Conformity ..... 10
- Default ..... 105
- Definitions ..... 11
- Derating ..... 280
- Digital comparators ..... 215
- Digital inputs
  - Board Relay ..... 211
  - DigIn 1 ..... 199
  - DigIn 2 ..... 200
  - DigIn 3 ..... 201
- Dismantling and scrapping ..... 10
- Display ..... 67
- Double-ended connection ..... 48
- Drive mode ..... 86
  - Frequency ..... 187
- Drives on Change ..... 162, 163

## E

- ECP ..... 267
- Edge control ..... 59, 90
- Electrical specification ..... 278
- EMC ..... 27
  - Current control (0-20mA) ..... 48
  - Double-ended connection ..... 48
  - RFI mains filter ..... 27
  - Single-ended connection ..... 48
  - Twisted cables ..... 49
- EN61800-3 ..... 10
- EN61800-5-1 ..... 10
- Enable ..... 57, 69, 199
- EXOR operator ..... 230
- Expression ..... 230
- External Control Panel ..... 267

<b>F</b>			
	Factory settings	105	
	Fans	160	
	Fieldbus	119, 270	
	Fixed MASTER	161	
	Flux optimization	149	
	Frequency	241	
	Frequency priority	56	
	Jog Frequency	146	
	Maximum Frequency	143	
	Minimum Frequency	142	
	Preset Frequency	151	
	Skip Frequency	144, 145	
	Frequency priority	56	
	Fuses, cable cross-sections and glands	282	
<b>I</b>			
	I/O Board	270	
	I2t protection		
	Motor I2t Current	98, 99, 101	
	Motor I2t Type	98	
	ID run	60, 95	
	Identification Run	60, 95	
	IEC269	282	
	Internal speed control	152	
	Internal speed controller	152	
	Speed I Time	154	
	Speed P Gain	153	
	Interrupt	120, 121, 122, 123	
	IT Mains supply	iv	
	IxR Compensation	147	
<b>J</b>			
	Jog Frequency	146	
<b>K</b>			
	Keyboard reference	152	
	Keys	69	
	- Key	72	
	+ Key	72	
	Control keys	69	
	ENTER key	72	
	ESCAPE key	72	
	Function keys	72	
	NEXT key	72	
	PREVIOUS key	72	
	RUN L	69	
	RUN R	69	
	STOP/RESET	69	
	Toggle Key	70	
<b>L</b>			
	LCD display	67	
	Level control	58, 90	
	Load default	105	
	Load monitor	62, 177	
	Local/Remote	88	
	Lock code	89	
	Long motor cables	30	
	Low Voltage Directive	10	
	Lower Band	164	
	Lower Band Limit	166	
<b>M</b>			
	Main menu	74	
	Mains supply	26, 38, 41	
	Maintenance	264	
	Manis cables	25	
	Max Frequency	131, 143, 144	
	Memory	61	
	Menu		
	(110)	84	
	(120)	84	
	(210)	85	
	(211)	85	
	(212)	85	
	(213)	86	
	(214)	86	
	(215)	87	
	(216)	87	
	(217)	88	
	(218)	89	
	(219)	89	
	(21A)	90	
	(220)	91	
	(221)	92	
	(222)	92	
	(223)	92	
	(224)	93	
	(225)	93	
	(226)	94	
	(227)	94	
	(228)	94	
	(229)	95	
	(22B)	96	
	(22C)	97	
	(22D)	97	
	(230)	98	
	(231)	98	
	(232)	98	
	(233)	99	
	(234)	100	
	(235)	101	
	(236)	101	
	(237)	102	
	(240)	102	
	(241)	102	
	(242)	103	
	(243)	105	
	(244)	105	
	(245)	106	
	(250)	106	
	(251)	107	
	(252)	108	
	(253)	108	
	(254)	108	
	(255)	109	
	(256)	109	



(257)	110	(33E)	140
(258)	110	(33F)	140
(259)	110	(33G)	140, 141
(25A)	111	(341)	142
(25B)	111	(342)	143
(25C)	111	(343)	143
(25D)	112	(344)	144
(25E)	112	(345)	145
(25F)	112	(346)	145
(25G)	113	(347)	146
(25H)	113	(348)	146
(25I)	113	(351)	147
(25J)	114	(354)	149
(25K)	114	(361)	150
(25L)	115	(362)	151
(25M)	115	(363)	151
(25N)	107, 115	(364)	151
(25O)	116	(365)	151
(25Q)	116	(366)	151
(25R)	116	(367)	151
(25S)	117	(368)	151
(25T)	117	(369)	152
(25U)	117	(371)	153
(260)	118	(372)	153
(261)	118	(373)	154
(262)	119	(380)	154
(2621)	119	(381)	154
(2622)	119	(383)	155
(263)	119	(384)	155
(2631)	119	(385)	155
(2632)	120	(386)	157
(2633)	120	(387)	157
(2634)	120	(388)	158
(264)	120	(389)	159
(265)	122	(391)	160
(269)	123	(392)	160
(310)	123	(393)	161
(320)	124	(394)	162
(321)	124	(395)	163
(322)	125	(396)	163
(323)	126	(398)	164
(324)	127	(399)	165
(325)	128	(39A)	165
(326)	128	(39B)	166
(327)	129	(39C)	166
(328)	129	(39D)	167
(331)	131	(39E)	167
(332)	132	(39F)	168, 171
(333)	132	(39G)	169
(334)	133	(39H-39M)	170
(335)	133	(410)	177
(336)	134	(411)	177
(337)	135	(412)	177
(338)	136	(413)	178
(339)	136	(414)	178
(33A)	137	(415)	178
(33B)	137	(416)	179
(33C)	138	(4162)	180
(33D)	139	(417)	180

(4171)	180	(625)	231
(4172)	180	(630)	233
(418)	181	(631)	233
(4181)	181	(632)	234
(4182)	181	(633)	234
(419)	181	(634)	234
(4191)	181	(635)	235
(4192)	182	(640)	235
(41A)	182	(641)	236
(41B)	183	(642)	236
(41C)	183	(643)	236
(421)	184	(644)	237
(422)	185	(645)	237
(423)	185	(649)	238
(424)	186	(650)	238
(511)	187	(651)	238
(512)	188	(652)	238
(513)	190	(653)	239
(514)	195	(654)	239
(515)	196	(655)	239
(516)	196	(659)	240
(517)	196	(711)	241
(518)	197	(712)	241
(519)	197	(713)	242
(51A)	197	(714)	242
(51B)	198	(715)	242
(51C)	198	(716)	243
(521)	141, 199	(717)	243
(522)	200	(718)	243
(529-52H)	201	(719)	244
(531)	201	(71A)	244
(532)	202	(71B)	244
(533)	203	(720)	245
(534)	206	(721)	245
(535)	206	(722)	246
(536)	207	(723)	247
(541)	207	(724)	247
(542)	210	(725)	248
(551)	210	(726)	249
(552)	210	(727)	249
(553)	211	(728-72A)	249
(55D)	212	(730)	250
(561)	213	(731)	250
(562)	213	(7311)	250
(563-56G)	214	(732)	251
(610)	215	(733)	251
(611)	215	(7331)	251
(612)	218	(800)	253
(613)	220, 221, 224, 226, 227, 228	(810)	253
(614)	223, 224, 226	(811)	253
(615)	223, 225, 227	(811-81N)	253, 254
(616)	223, 225, 227	(820)	254
(617)	228	(8A0)	255
(618)	229	(900)	256
(620)	230	(920)	256
(621)	230, 231	(922)	256
(622)	231, 232	Minimum Frequency	134
(623)	231, 232	Monitor function	
(624)	231	Alarm Select	183

Delay time	178	<b>Q</b>	Quick Setup Card	7
Max Alarm	177			
Overload	62, 177	<b>R</b>	Reference	
Response delay	180, 183		Frequency	184
Start delay	178		Motor potentiometer	199
Motor cables	27		Reference signal	86, 123
Motor cos phi (power factor)	94		Set reference value	123
Motor data	91		Torque	185
Motor Frequency	92		View reference value	123
Motor frequency	93		Reference control	86
Motor I2t Current	262		Reference signal	86, 87
Motor identification run	95		Relay output	210
Motor Potentiometer	150, 199		Relay 1	210
Motor potentiometer	199		Relay 2	210
Motor ventilation	94		Relay 3	211
Motors	7		Release speed	139
Motors in parallel	35		Remote control	57
MotPot	133		Reset command	199
			Reset control	87
<b>N</b>			Resolution	83
Nominal motor frequency	143		RFI mains filter	27
Number of drives	160		Rotation	89
			RS232/485	118, 119
<b>O</b>			RUN	69
Operation	85		Run command	69
Options	49		Run Left command	199
Brake chopper	268		Run Right command	199
External Control Panel (ECP)	267		Running motor	137
I/O Board	270			
Output coils	270	<b>S</b>	Select Drive	160, 161
Protection class IP23 and IP54	267		Settle Time	167
Serial communication, fieldbus	270		Setup menu	74
OR operator	230		Menu structure	73
Output coils	270		Signal ground	286
Overload	62, 177		Single-ended connection	48
Overload alarm	62		Software	256
			Speed	241
<b>P</b>			Speed Mode	86
Parameter sets			Spinstart	137
Load default values	105		Standards	8
Load parameter sets from Control Panel	106		Start Delay	165
Parameter Set Selection	54		Start/Stop settings	131
Select a Parameter set	102		Status indications	68
PI Autotune	153		Stop command	199
PID Controller	154		Stop Delay	165
Closed loop PID control	155		Stripping lengths	34
Feedback signal	154		Switches	43
PID D Time	155		Switching in motor cables	30
PID I Time	155	<b>T</b>	Terminal connections	42
PID P Gain	155		Test Run	95
Power LED	69		Timer	162
Priority	56		Torque	83, 147
Process Value	241		Transition Frequency	167
Product standard, EMC	9		Trip	69
Programming	74			
Protection class IP23 and IP54	267			
PT100 Inputs	101, 102			
PTC input	100			
Pump/Fan Control	160			

Trip causes and remedial action .....	261
Trips, warnings and limits .....	259
Twisted cables .....	49
Type .....	256
Type code number .....	8

**U**

Underload .....	62
Underload alarm .....	177
Unlock Code .....	89
Upper Band .....	163
Upper Band Limit .....	166

**V**

V/Hz Mode .....	86
Vector Brake .....	140
Ventilation .....	94
View reference value .....	123
Voltage .....	43

**W**

Warning .....	253
---------------	-----